

VX2200 DIGITAL SYSTEM



TECHNICAL MANUAL
EDITION 1.5



CONTENTS

	PAGE
Manual introduction	4
System introduction	4
Digital door panels	5-9
Digital door panel programming flow chart	7-8
4000 Series / 8000 Series Functional door panels	10-12
Vandal resistant functional door panels (Amplifier 138)	13-14
Camera's	15
Video Distribution	16
Control equipment	17-23
Power supplies	17
Digital time clock	18-19
Video switching PCB	20
Isolation card	21-22
Bus exchange device	22-23
Concierge unit	24-26
Concierge unit programming flow chart	26
2280 Bus interface device	27
Audio telephones	28-29
Audio apartment station Art.5178	30-31
Videophones	32-34
Video apartment station Art.5478, 5476, SL5478	35-37
Vandal resistant apartment stations VR5178, VR5478	37-39
3600 Series Videophone (3678)	40-41
Extension sounders and extension relays	42
Installation directions EMI guidelines and cable guide	43-46
Dip-Switch charts	46-48
Troubleshooting guide	49
Wiring Diagrams	
One entrance audio system	50
One entrance audio system with telephones and apartment stations	51
Multiple entrance audio system	52
Audio with 2204N full isolation	53
Audio system with concierge	54
2 Level audio system with main gate and multiple block entrances	55
One entrance video system	56
Multiple entrance video system	57
Multiple entrance video with concierge	58
Coax video example	59
2 level video system using the 2206N block exchanger	60-61
Video with 2204N/316I full isolation	62
System components	63-65
EMC Test results	66

MANUAL INTRODUCTION

The information in this manual is intended as an installation and commissioning guide for the VX2200 Digital system. This manual should be read carefully before the installation commences. Any damage caused to the equipment due to faulty installations where the information in this manual has not been followed is not the responsibility of Videx Security Ltd.

VIDEX run free training courses for engineers who are not familiar with the Videx product range. Technical help is also available on 0191 224 3174 during office hours or via e-mail tech@videx-security.com.

SYSTEM INTRODUCTION

The VX2200 audio system is based on a “**2 wire**” **BUS** for audio systems and a “**6 wire**” bus for video systems. The digital front panels are available in several versions including the 8000 series design (With either alphanumeric A-H feature or Name scroll feature), 4000 series design (With either alphanumeric A-F feature or Name scroll feature) and vandal resistant with optional alpha buttons A-H. All digital panels have the facility to call up to 998 users (when using 2206N bus exchange devices, 180 per block/bus). Digital panels also benefit from each user having the additional feature of a personal access code to gain access to the building. Functional panels are also available with up to 64 buttons. All intercom telephones are addressed by means of an 8 way dip-switch located within each handset.

DIGITAL PANELS



Digital panels are available in the 8000 Series, 4000 Series and vandal resistant. The difference is mainly aesthetics; they all share the same connections, volume adjustments and programming menu. Digital panels can also be programmed with a PC using the SP37 programming kit. The PC connects to the panel via a jack socket located in the rear of the panel. Call progress is shown on a 2 line back lit LCD display. The panels also benefit from voice announcement and call progress tones which guide the caller through the process of contacting an apartment.

CONNECTION	FUNCTION
GND	0V connection from PSU and ground connection
+12	12-14Vdc from PSU
-	0V connection to bus
L	Bus connection (Data, speech and power)
BS	Busy connection for multiple door systems
SL	Switched 0V output (Triggers during a call, for the duration of the call)
NC	Normally closed connection of the dry contact relay output
C	Common connection of the dry contact relay output
NO	Normally open connection of the dry contact relay output
TRD	Trade code enable (Switched 0V to enable)
PTE	Push to exit button input (Switched 0V to trigger relay output)

JUMPERS

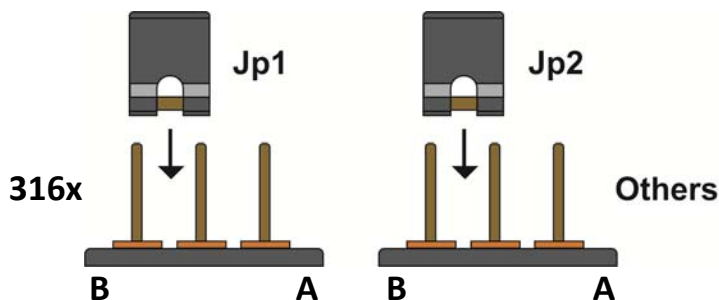

The two jumpers on the panel must be set before powering up to initialise the panel in the correct mode. When using 3161 or 3162 telephones the jumper's must be in the 'B' (316x) position, for all other telephones, videophones and video monitors the jumper's should be in the 'A' (Others) position.

VOLUME ADJUSTMENT

There are four volume adjusters on the door panel as follows:-



Speaker volume



Microphone volume

BALANCE



Balance between mic volume and speaker volume



SPEECH

Voice annunciation volume (May also be labelled 'V.PB CHIP')

MAKING A CALL

All stages of the call will be acknowledged via the LCD display, voice annunciation and call progress tones. Additionally, the panel will also prompt the user with information on how to progress to the next stage of the call. To make a call simply enter the apartment number required and press 'Enter'. Alternatively, if the panel has the scroll buttons ('←', '↻', '→') use the '←', '→' to locate the apartment to call then press '↻'.

USING THE TRADE

On the 4000 Series and 8000 Series panels the trade feature can only be used with a code. To use this facility first the TRD connection must be shorted to ground (As shown in the diagram to the right). To enter a trade code the panel must be in standby. Press the clear button (Display will show 'TRADE C'), enter the code and then press 'Enter'.

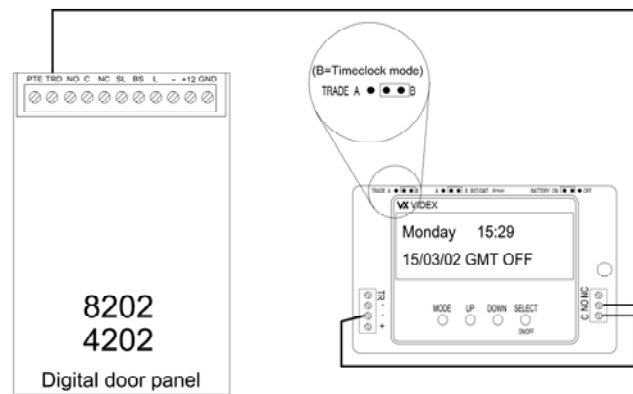

On the vandal resistant panel the trade button can be used as described above or alternatively the trade button can be used to simply release the door when the button is pressed (As long as the time clock is active). See diagram below for wiring these options.

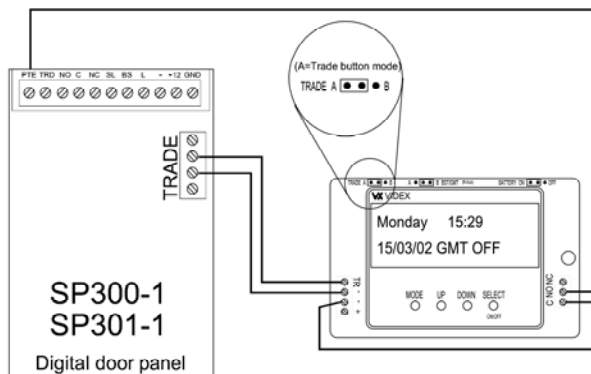

WITHOUT CODE

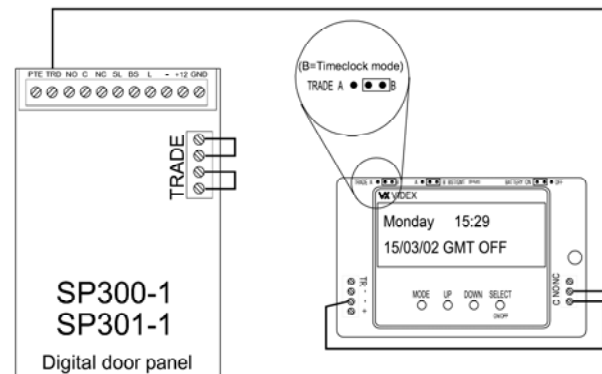

WITH CODE

USING AN ACCESS CODE AND ENTERING PROGRAMMING MODE

On panels with a 'CODE' button, press 'CODE' followed by the code and press 'Enter'. For panels without a 'CODE' button, press '0' followed by the code and press 'Enter'

Technical specifications

Memory capacity	: 998 users
Working voltage	: 13 Vdc +/- 10%
Max. absorption	: about 350 mA
Working temperature	: -10 +50 C°
Relay contacts	: 3A@30Vdc, 3A@120Vac

DIGITAL PANEL PROGRAMMING

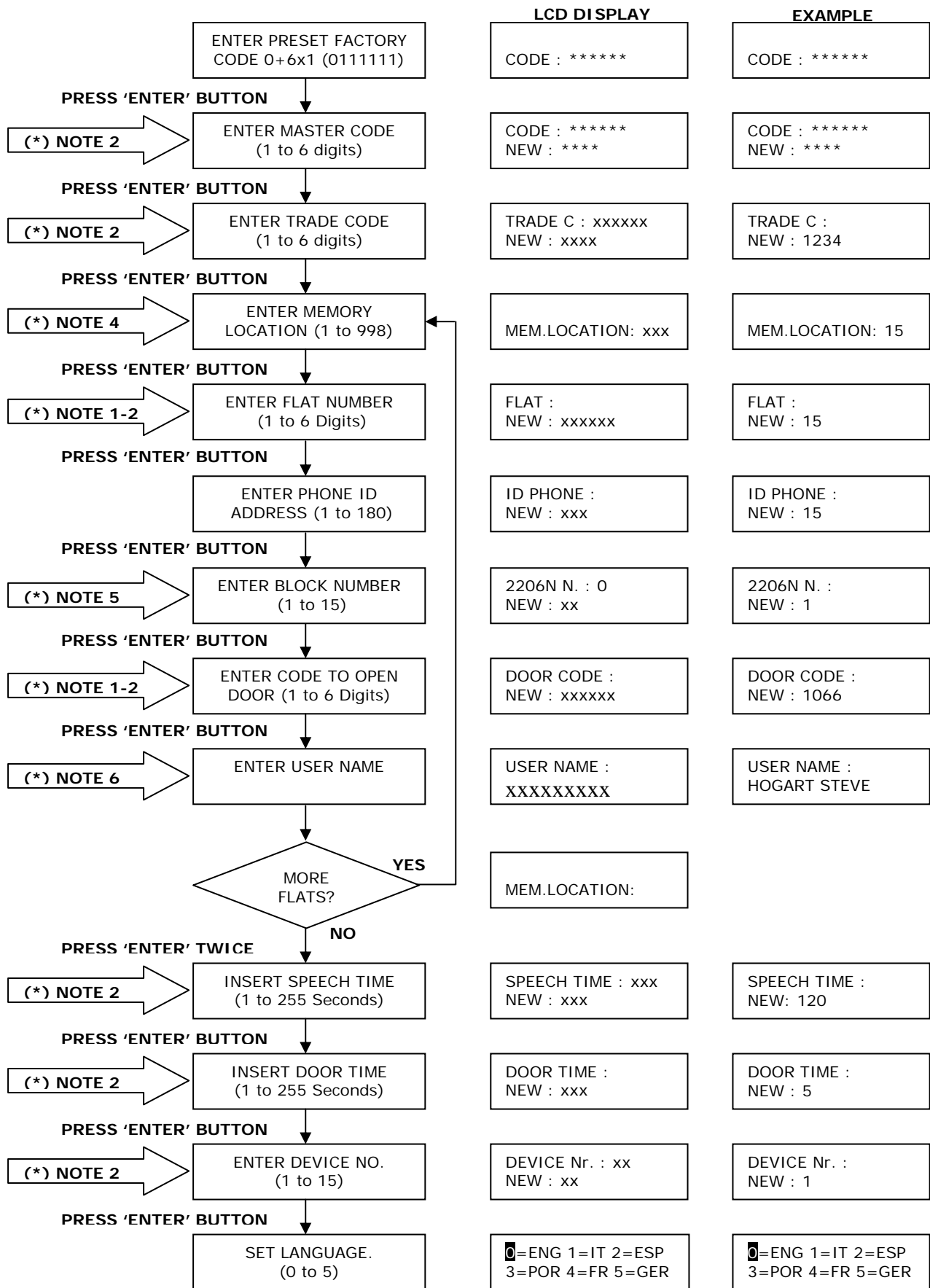

CONTINUED ON NEXT PAGE

CONTINUED FROM PREVIOUS PAGE

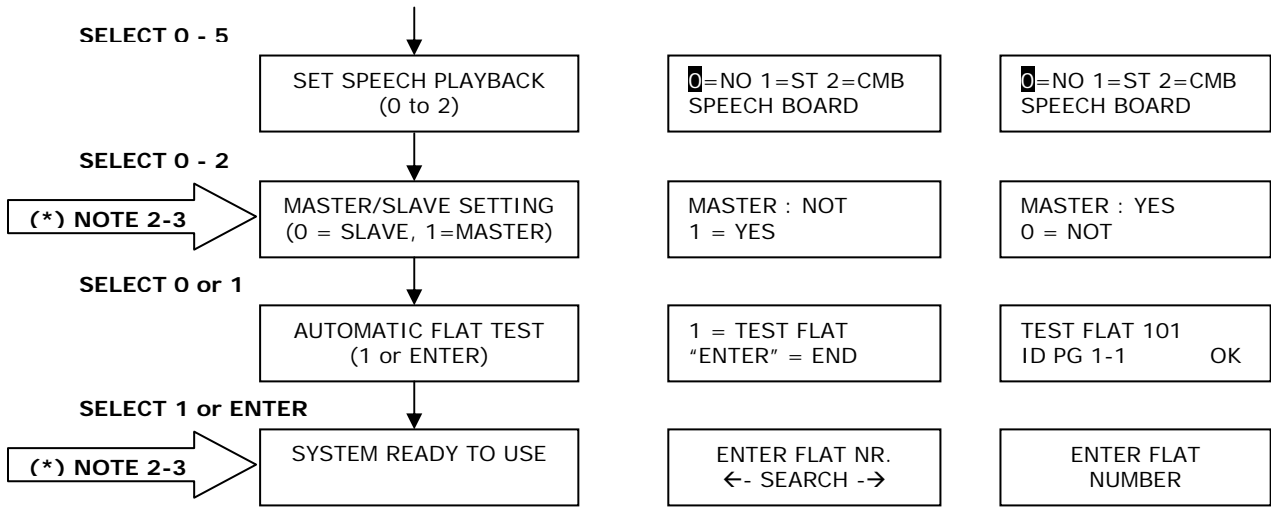

NOTES:-

(*) NOTE 1 →

PRESS CLEAR BUTTON TO CANCEL THE LOCATION

(*) NOTE 2 →

DURING THE PROGRAMMING TO CONFIRM THE STORED DATA, PRESS ENTER TWICE

(*) NOTE 3 →

PROGRAM AS SLAVE ONLY IF THERE IS ANOTHER ENTRANCE PROGRAMMED AS MASTER ON THE SAME BUS

(*) NOTE 4 →

DOOR PANEL SOFTWARE VERSION 5.0 or later: LOCATIONS 0 & 999 ARE RESERVED FOR EDITING THE DISPLAY LOGOS.

EARLIER SOFTWARE: LOCATIONS 0 & 255 ARE RESERVED FOR EDITING THE DISPLAY LOGOS.

(*) NOTE 5 →

THIS SCREEN WILL ONLY APPEAR IF THE DOOR PANEL IS IN MAIN MODE. POWER UP WITH 0 HELD IN FOR **MAIN MODE**, POWER UP WITH ENTER HELD IN FOR **LOCAL MODE**

(*) NOTE 6 →

THIS SCREEN WILL ONLY APPEAR ON NAME SCROLL FACILITY DOOR PANELS. THE FOLLOWING KEYS ON THE KEYPAD DOUBLE UP AS LETTERS WHEN ENTERING NAMES: -

← or A = Back	CALL or B = Accept	→ or C = Forward
1 = .&	2 = ABC	3 = DEF
4 = GHI	5 = JKL	6 = MNO
7 = PQRS	8 = TUV	9 = WXYZ
	0 = +-* /	

DIGITAL PANEL MODE

The digital panel can be set to either **MAIN MODE** or **LOCAL MODE**. MAIN mode should only be used for panels that call all users and on systems that include 2206N devices (One per block or one for every 180 apartments), use LOCAL mode for all other applications. To set a digital panel as **MAIN MODE**, power up with the 0 button pressed. To set as **LOCAL MODE**, power up with ENTER pressed (The mode can also be changed via the PC programming software).

To use the digital front panel with 3000 series intercoms and videointercoms, press the “**ENTER**” button while powering up and wait until the display shows the message “**S3000**”, release the button.

To use the digital front panel with 900 series intercoms and videointercoms, press the “**CLEAR**” button while powering up and wait until the display shows the message “**S900**”, release the button.

Additional programming notes

- a. During the programming of the master door panel, all slave door panels will be off line. (This inconvenience does not occur if the slave entrances are connected through Art.2206 on a separate bus);
- b. If the programming of the MASTER device is wrong (Eg. Programmed as a SLAVE when it should be a MASTER), an error condition takes place signalled by the message “ERROR!” on the display. To recover from this situation keep the “0” button pressed until the display shows CODE. Perform the programming again correcting the error. Alternatively programming a SLAVE as a MASTER can cause feedback (Larsen effect) during the conversation (Only one master per level per block allowed).
- c. The entering of values not admitted is signalled by an error message, the unit waits for a valid entry before continuing on with the programming.
- d. Pressing the “CLEAR” button, at any stage will clear the current data previously entered.
- e. To enter a number to call the concierge (if present) while the concierge is in night mode, combine the “flat number” (Concierge number) with the “ID PHONE” address n.1.
- f. When using the door panel in MAIN MODE, the programming of each user will require the address of the 2206N (Block address) for which that user is connected.

4000 SERIES/8000 SERIES FUNCTIONAL PANELS



4203

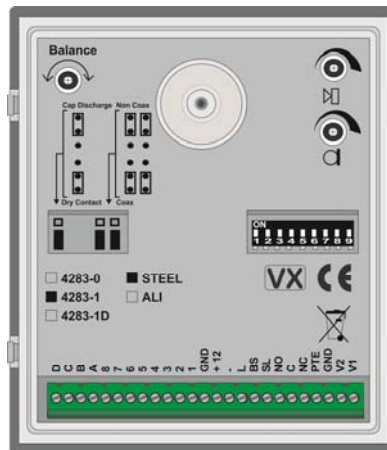

4283

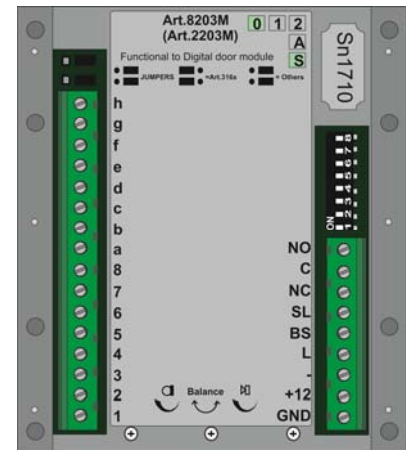

8203

The 4000 and 8000 Series functional panels are of modular design each being capable of expansion up to 64 call buttons (only 32 buttons on the 4283 combined camera and speaker module). Programming options are carried out via dip-switches. Call progress tones are used to indicate the status of a call.

CONNECTION	FUNCTION
GND	0V connection from PSU and ground connection
+12	12-14Vdc from PSU
-	0V connection to bus
L	Bus connection (Data, speech and power)
BS/BSY	Busy connection for multiple door systems
SL	Switched 0V output (Triggers during a call, for the duration of the call)
NC	Normally closed connection of the dry contact relay output
C	Common connection of the dry contact relay output
NO	Normally open connection of the dry contact relay output
PTE	Push to exit button input (Switched 0V to trigger relay output)
V1	+Sync of balanced video signal from camera (4283 only)
V2/V	- Sync of balanced video signal from camera (4283 only) When in coax mode used as video signal, screen of coax connects to GND

MAKING A CALL

Press the relevant button: 5 quick beeps will indicate if the system is busy, otherwise the call will be signalled by a slow intermittent acoustic signal until the call is answered, the conversation time expires (programmable time) or the call is interrupted by pressing a push button for a minimum of 2 seconds. A short intermittent acoustic signal indicates that the door is open. If a wrong push button is pressed or if there is no answer, a new call will erase the previous one.

JUMPERS

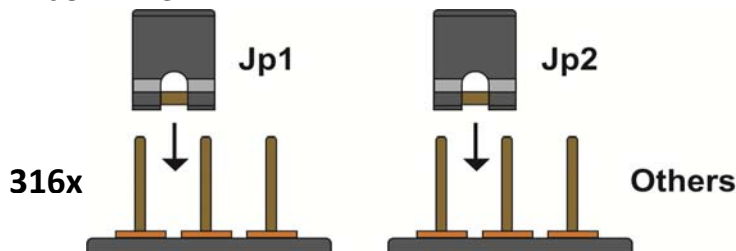

The two jumpers on the 4203 & 8203 panel must be set before powering up to initialise the panel in the correct mode. When using 3161 or 3162 telephones the jumper's must be in the '316x' position, for all other telephones, videophones and video monitors the jumper's should be in the 'Others' position.

There are also three jumpers on the 4283 module which set the lock output to either dry contact (C, NO & NC) or voltage output (Lock connects across GND and NO, NO being a 12Vdc output) and the other two are used to select the video output to be either balanced or composite.

VOLUME ADJUSTMENT

There are three volume adjusters on the door panel as follows:-



Speaker volume



Microphone volume

BALANCE



Balance between microphone volume and speaker volume

CONNECTING ADDITIONAL BUTTONS

Up to 64 buttons (32 on the 4283) can be connected to the modules using an X-Y matrix as shown here.

When using the 4000 Series button modules you will notice a number of jumpers on these modules which allow you to select if the buttons are common or isolated from each other.

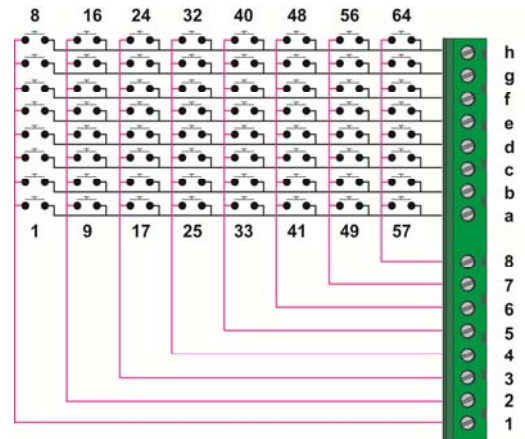
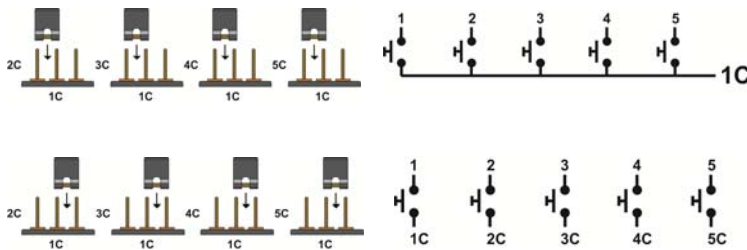

DIP SWITCHES (4203 & 8203)

All DIP-SWITCH CHANGES MUST BE CONFIRMED BY POWERING DOWN THE MODULE AND THEN POWERING UP AGAIN.

Nr.1	Setting Up
OFF	= Slave
ON	= Master (default)

Switch 1 sets the panel as a Master or Slave. One master required on each bus.

Nr.2	Nr.3	Settings
OFF	OFF	from buttons 1 to 64
ON	OFF	from buttons 65 to 128
OFF	ON	from buttons 129 to 180
ON	ON	from buttons 1 to 64 with 900 series devices

Switches 2 & 3 define the range of Phone IDs generated by the unit when the call buttons are pressed. For example with dip-switch 2 and 3 both OFF, the push button connected between terminals "1" and "a" calls ID PHONE 1 while the same push button, with dip-switch 2 ON and dip-switch 3 OFF, will call PHONE ID 65.

Nr.4	Setting Up
OFF	= 1 min
ON	= 2 min

Switch 4 sets the maximum conversation time.

Nr.5	Setting Up
OFF	= 2 seconds
ON	= 6 seconds

Switch 5 sets the relay operation time.

Nr.6	Nr.7	Nr.8	Setting Up
OFF	OFF	OFF	= 1
ON	OFF	OFF	= 2
OFF	ON	OFF	= 3
ON	ON	OFF	= 4
OFF	OFF	ON	= 5
ON	OFF	ON	= 6
OFF	ON	ON	= 7
ON	ON	ON	= 8

Switches 6, 7 & 8 set the panels ID. This is required on video systems and systems that include a concierge as it allows an apartment or the concierge to recall the panel to activate the camera, switch on the audio and also identifies to the concierge which panel a call originates.

DIP SWITCHES (4283)

ALL DIP-SWITCH CHANGES MUST BE CONFIRMED BY POWERING DOWN THE MODULE AND THEN POWERING UP AGAIN.

Nr.1	Setting Up
OFF	= Slave
ON	= Master (default)

Switch 1 sets the panel as a Master or Slave. One master required on each bus.

Nr.2	Nr.3	Nr.4	Settings
OFF	OFF	OFF	from buttons 1 to 32
ON	OFF	OFF	from buttons 33 to 64
OFF	ON	OFF	from buttons 65 to 96
ON	ON	OFF	from buttons 97 to 128
OFF	OFF	ON	from buttons 129 to 160
ON	OFF	ON	from buttons 161 to 180
OFF	ON	ON	from buttons 1 to 32 (900 Series phones)
ON	ON	ON	from buttons 33 to 64 (900 Series phones)

Switches 2, 3 & 4 define the range of Phone IDs generated by the unit when the call buttons are pressed. For example with dip-switch 2, 3 and 4 OFF, the push button connected between terminals "1" and "a" calls **ID PHONE 1** while the same push button, with dip-switch 2 ON and dip-switch 3 & 4 OFF, will call **PHONE ID 33**.

Nr.5	Setting Up
OFF	= 1 min
ON	= 2 min

Switch 5 sets the maximum conversation time.

Nr.6	Setting Up
OFF	= 2 seconds
ON	= 6 seconds

Switch 6 sets the relay operation time.

Nr.7	Nr.8	Nr.9	Setting Up
OFF	OFF	OFF	= 1
ON	OFF	OFF	= 2
OFF	ON	OFF	= 3
ON	ON	OFF	= 4
OFF	OFF	ON	= 5
ON	OFF	ON	= 6
OFF	ON	ON	= 7
ON	ON	ON	= 8

Switches 7, 8 & 9 set the panels ID. This is required on video systems and systems which include a concierge as it allows an apartment or the concierge to recall the panel to activate the camera and also identifies to the concierge which panel a call is coming from.

Switch 10 not used.

Programming notes

In case of a wrong Master/Slave configuration (Dip-switch no.1), the following problems can occur:





- if the unit should be a Master but is configured as a Slave, the error is signalled by an acoustic intermittent signal until the problem is resolved;
- if the unit should be Slave but is configured as Master, the impedance of the system will have a lack of balance, causing feedback ("Larsen" effect).

When a system includes a concierge unit, the push button combined with the **Phone ID 1** will call to the concierge regardless of if the concierge is in day or night mode.

MODULE BUTTON WIRING COLOUR CODE:-

Colour	Button
blue	Buttons Common
yellow	Button 1
red	Button 2
white	Button 3 (4000 Series only)
black	Button 4 (4000 Series only)

CALL PROGRESS LED'S

Symbol	LED meaning
	The first LED (red), indicates that it is not possible to make a call because a call or a conversation is in progress (from the outdoor station from which you are calling or from another outdoor station on systems with multiple entrances).
	The second LED (red), indicates that a call is in progress. The LED will switch OFF when the call is answered.
	The third LED (yellow), indicates the call has been answered. The LED will switch OFF at the end of the conversation.
	The fourth LED (green), indicates that the door lock has been released. It will switch OFF at the end of the "door opening" time.

Technical specifications

Working voltage	: 13 Vdc +/- 10%
Max. absorption	: approx 350 mA
Working temperature	: -10 +50 C°
Relay contacts	: 3A@30Vdc, 3A@120Vac

VANDAL RESISTANT FUNCTIONAL PANELS



This module is used in the VX2200 2 wire audio, 6 wire video functional vandal resistant door panels and includes all features required for audio & video installations. A 13.8Vdc PSU is required to power this system. Up to 23 buttons can be connected to this module. (This module cannot be used with 316x phones).

MAKING A CALL

Press the relevant button: 5 quick beeps will indicate if the system is busy, otherwise the call will be signalled by a slow intermittent acoustic signal until the call is answered, times out or the call is interrupted by pressing a push button for more than 2 seconds. A short intermittent acoustic signal indicates that the door is open. A yellow LED indicates conversation has begun and a green LED indicates relay activation.

CONNECTION	FUNCTION
NC	Normally closed connection of relay
C	Common connection of relay
NO	Normally open connection of relay
PTE	Push to exit button input (Switch to 0V)
SL	Switched 0V output (0V during a call for video power supply switching)
BS	Busy signal to other panels (12Vdc in standby, 0V during a call)
L	Bus connection approx. 7.5Vdc
-	0V for bus
+12	12Vdc input to power the amplifier
-	0V from PSU

VOLUME ADJUSTMENT

There are three volume adjusters on the door panel as follows:-



Speaker volume



Microphone volume

BALANCE



Balance between microphone volume and speaker volume

CONNECTING ADDITIONAL BUTTONS

Up to 23 buttons can be connected to the modules using an X-Y matrix and the wiring harness as shown here.

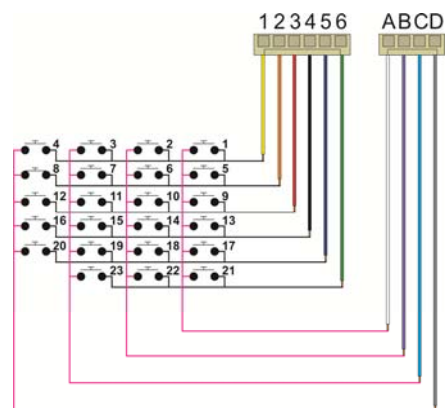

Factory reset

To revert to factory default settings as shown in () below, power down the 138 amplifier short PTE to ground, power up and await 6 beeps, remove the short.

Programming

There are several features of the amplifier that can be programmed into non-volatile memory. Entering each programming stage requires the shorting of certain connections on the button matrix using the connectors 5 & 6 labelled above. Remove the plug from connector ABCD so that the connectors 5 or 6 can be connected to the relevant pin as outlined in the tables below. Beeps are used to indicate the new setting as outlined in the tables below. The procedure to program these settings is as follows:-

1. Power down the 138 amplifier
2. Connect the plug (5 or 6) to A,B,C or D depending on the setting to program as outlined below.
3. Power up the 138 amplifier
4. Listen to the beeps from the 138 amplifier, When the correct number is reached as outlined below, remove the link between the plug and A,B,C or D.
5. A long confirmation beep will confirm the new setting has been stored.

DEFAULTS ARE SHOWN IN ()

MASTER or SLAVE

Set amplifier as master or slave (Each system requires one master, any additional door's on a system must be set to slave).

Power up with **wires 5 & A shorted**. Wait for correct beeps then remove short.

1 BEEP	2 BEEPS
(Master)	Slave

BANK of BUTTONS

Set the bank of buttons relevant to the button matrix (For most systems this will be buttons 1-23 but for larger systems it may be necessary to have the buttons start at 25 through to 47, i.e. Button 1A would call address 25 as oppose to 1).

Power up with **wires 5 & B shorted**. Wait for correct beeps then remove short.

1 BEEP	2 BEEPS
(Button addresses 1 – 23)	Button addresses 25-47

MAXIMUM CALLING TIME BEFORE ANSWER

Set the maximum length of a call 'wait to answer' before the call is cleared down. This does not affect the conversation time which can be programmed separately.

Power up with **wires 5 & C shorted**. Wait for correct beeps then remove short.

1 BEEP	2 BEEPS	3 BEEPS	4 BEEPS	5 BEEPS
10 Seconds	20 Seconds	30 Seconds	(40Seconds)	50Seconds
6 BEEP	7 BEEPS	8 BEEPS	9 BEEPS	10 BEEPS
60 Seconds	70 Seconds	80 Seconds	90Seconds	100Seconds

CONVERSATION TIME

Set the maximum length of a conversation before the call is automatically cleared down.

Power up with **wires 5 & D shorted**. Wait for correct beeps then remove short.

1 BEEP	2 BEEPS	3 BEEPS	4 BEEPS	5 BEEPS
20 Seconds	40 Seconds	(60 Seconds)	80 Seconds	100 Seconds
6 BEEP	7 BEEPS	8 BEEPS	9 BEEPS	10 BEEPS
120 Seconds	140 Seconds	160 Seconds	180 Seconds	200 Seconds

RELAY TIME

Door open relay time

Power up with **wires 6 & A shorted**. Wait for correct beeps then remove short.

1 BEEP	2 BEEPS	3 BEEPS	4 BEEPS	5 BEEPS
2.5 Seconds	(5 Seconds)	7.5 Seconds	10 Seconds	12.5 Seconds
6 BEEP	7 BEEPS	8 BEEPS	9 BEEPS	10 BEEPS
15 Seconds	17.5 Seconds	20 Seconds	22.5 Seconds	25 Seconds

DEVICE NUMBER

It is very important on video systems and systems with a concierge that each door panel amplifier has a unique device number.

Power up with **wires 6 & B shorted**. Wait for correct beeps then remove short.

1 BEEP	2 BEEPS	3 BEEPS	4 BEEPS	5 BEEPS
(Device 1)	Device 2	Device 3	Device 4	Device 5
6 BEEP	7 BEEPS	8 BEEPS	9 BEEPS	10 BEEPS
Device 6	Device 7	Device 8	Device 9	Device 10

CAMERA MODULES

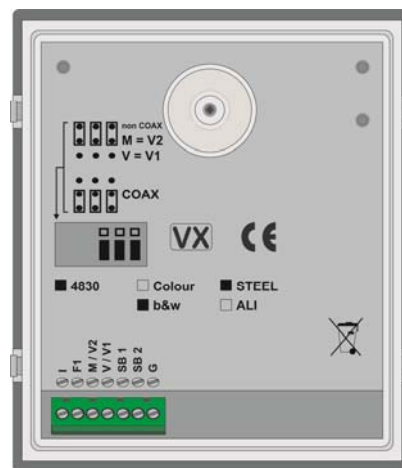

All camera modules are available in mono or colour. The mono cameras include infra-red illumination to illuminate a subject in poor lighting conditions (max range 80cm). The colour cameras include white LED's which switch on during a call. With the exception of the 830 and 830NC, the cameras are all able to support both balanced and composite video outputs which is selectable, adjusting the position of the jumpers. The 4000, 8000 and VR

cameras all include a ball joint camera swivel allowing the camera direction to be adjusted 10° in any direction.

CONNECTION	FUNCTION
I, +	Switched +20Vdc Input to power camera
F1, -	0V power to camera
V	Composite video output (Coax centre core)
M	Screen of coax
V1	+Sync balanced video connection
V2	- Sync balanced video connection
SB, SB1, SB2	Heater connections
G	Ground
12VI	Alternate 12Vdc supply (Used instead of 20Vdc into I)

JUMPERS

On camera's which include jumpers these should be set according to the type of video signal used. If the video signal and cable type is composite with coax cable then ensure all jumpers are towards the 'COAX' position. Alternatively if the video is a balanced signal using twisted pair cable then ensure the jumpers are all set to NC (Non Coax).

VIDEO DISTRIBUTION

COAX VIDEO

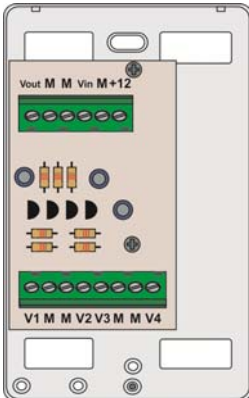

The version to the left is the Art.894 and the version to the right is the 894I. Both versions are 4 way video splitters therefore one is required for every four videophones.

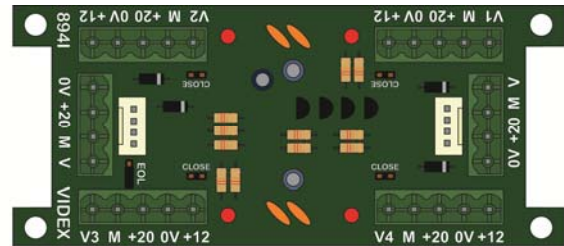

The 894I also benefits from over current protection for each of the four 20V (500mA max) outputs meaning, if a short appears on those connections or a fault towards the monitor occurs then the 20V to that output will be disconnected to allow all other outputs to continue working. The red LED next to the output will illuminate to show the problem output.

CONNECTION	FUNCTION
Vin, V	Video in from previous video distributor, control cabinet or camera
M	Coax cable screen
Vout, V	Video out to next video distributor or end of line termination.
V1, V2, V3, V4	Video output to four videophones (4 outputs)
+12	12V input to power the video distributor (Powered from videophones)
+20	20Vdc feed through from video power supply to monitors (894I only)
0V	0V feed through from video power supply to monitors (894I only)

NON-COAX (BALANCED VIDEO)

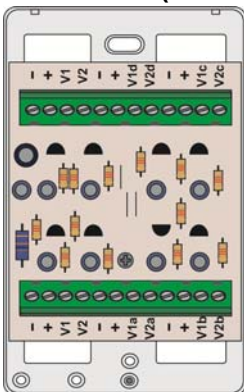

The version to the left is the Art.316 and the version to the right is the 316I. Both versions are 4 way video splitters therefore one is required for every four videophones.

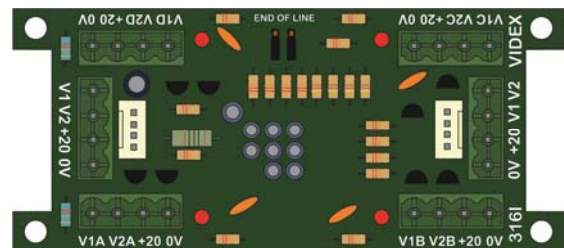

The 316I also benefits from over current protection for each of the four 20V (500mA max) outputs meaning, if a short appears on those connections or a fault towards the monitor occurs then the 20V to that output will be disconnected to allow all other outputs to continue working. The red LED next to the output will illuminate to show the problem output.

CONNECTION	FUNCTION
V1	+ Sync balanced video in from previous video distributor, control cabinet or camera
V2	- Sync balanced video in from previous video distributor, control cabinet or camera
V1a, V1b, V1c, V1d	+ Sync video output to videophone (4 Outputs)
V2a, V2b, V2c, V2d	- Sync video output to videophone (4 Outputs)
+20, +	20Vdc feed through to monitors and power from video power supply
0V, -	0V feed through from video power supply to monitors

END OF LINE

On coax video systems it is necessary to terminate any unused outputs with a 75Ω resistor. This is achieved on the 894 by fitting a 75Ω resistor across Vn and M of the unused outputs. On the 894I there are jumpers next to each output which should be closed if the output is not used and open if it is. Additionally it is also necessary to fit an end of line resistor across Vout & M of the last video distributor (Both coax and non-coax versions) to terminate the end of the line. Again on the 894I/316I there is a jumper(s) which should be closed on the last unit instead of fitting a resistor (Labelled EOL on the 894I and End of line on the 316I).

CONTROL EQUIPEMENT

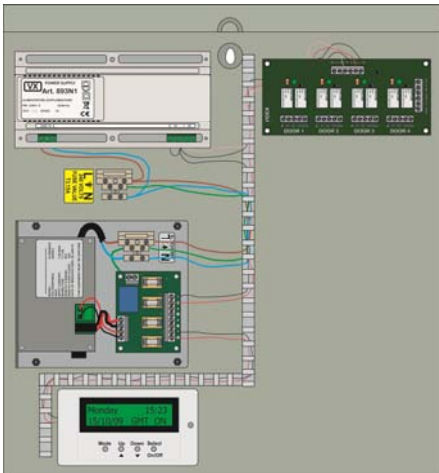

As there are many variations of control cabinet available (Audio, video, with isolation, multiple door etc). The components that make up a control cabinet are listed below:-

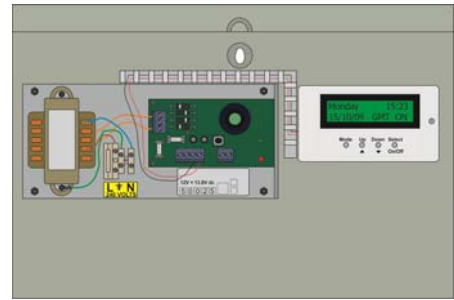

13.8Vdc SYSTEM PSU

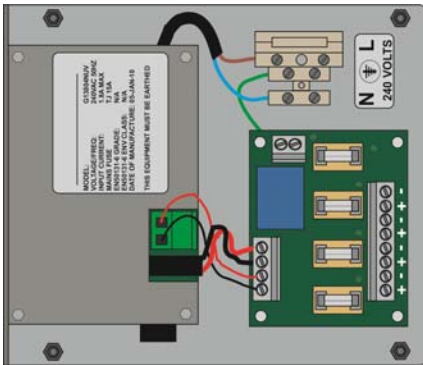

Battery backup is a standard feature of these PSU's. We recommend a 7Ah sealed lead acid battery. 1A, 2A, 3A & 4A PSU's are normally used on this system, all of which have a regulated output voltage of 13.8Vdc. DC out and battery trickle charge are independently fused. Additionally the 4A PSU includes a fan out PCB which shares the available 4A's between 4 independently fused outputs. The combination of these fuse values can be anything as long as the 4 outputs are fused to no more than 4A. Fuse values are as follows:-

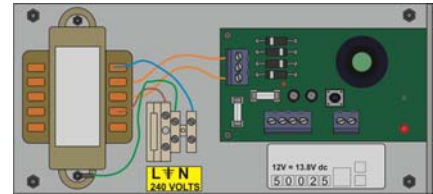

PSU	MAINS FUSE	DC OUT FUSE	BATTERY TRICKLE CHARGE FUSE
2 Amp	T315mA	F2.0A	T315mA
3 Amp	T630mA	F3.0A	T315mA
4 Amp	T3.15A	Main fuse F4.0A. Fan out fuses can be any combination up to a total of 4A	T1A

20Vdc VIDEO PSU

The Art.893N1 is a 1A pulse, 800mA continuous 20Vdc PSU. It is a switched output supply requiring either a positive trigger on terminal '+C' or a negative trigger on '-C' to switch the 20Vdc output on. There are no fuses in this PSU. If there is a short on the output or an over current situation then the PSU will shut down until the problem is resolved.

CONNECTION	FUNCTION
-C	0V trigger to activate output
+C	+8-30Vdc to activate output
-	0V output connection
+	20Vdc output connection
+D	20Vdc output via diode

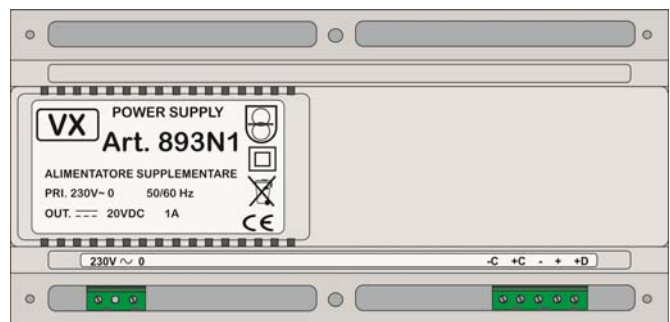

TIME CLOCK

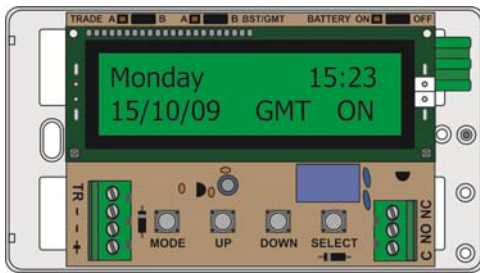

The 701T is a BST/GMT time clock with 6 programmable on/off periods and two modes of operation. The first mode being a standard time clock mode whereby the dry contact relay output triggers for the length of an on/off period. The second mode is known as the trade button mode and only operates the relay when the trade input is triggered and during an active on/off period. The relay would then stay energised for a programmed time (01-99 seconds).

CONNECTION	FUNCTION
+	12Vdc power supply input
-	0V power supply connection
TR	Trade button input (Shorts to 0V)
C	Common connection of dry contact relay output
NO	Normally open connection of dry contact relay output
NC	Normally closed connection of dry contact relay output

JUMPERS

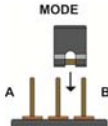

The jumper in the top right selects the time clocks mode of operation.
 A = TRADE BUTTON MODE
 B = TIME CLOCK MODE



The jumper in the middle Enables/Disables automatic BST/GMT time correction
 A = AUTOMATIC ADJUSTMENT DISABLED
 B = AUTOMATIC ADJUSTMENT ENABLED

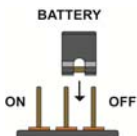

The time clock includes a battery to maintain the time while the time clock isn't powered. The battery should maintain the time and settings for a minimum of 3 months.
 ON = BATTERY ENABLED
 OFF = BATTERY DISABLED (Should be moved to ON when installed)

TECHNICAL SPECIFICATION

Supply Voltage	:	12V DC or 12V AC
Standby Current (Relay off)	:	47mA
Standby Current (Relay on)	:	67mA
Battery backup	:	Min. 3 Months
Relay contacts (Dry contact)	:	3A @ 24V DC 3A @ 120V AC
On/Off times available	:	Six
	:	ON/OFF period 1 will switch off at the off time for that period regardless of manual override.
	:	ON/OFF period 2-6 will <u>Not</u> switch off at the off time for that period if manual override is pressed.
Trade mode relay time	:	From 1 second to 99 seconds
Dimensions	:	110mm x 70mm x 30mm

TIME CLOCK PROGRAMMING

Programming is carried out by means of the four push buttons. The mode button advances through the modes beginning with mode 1 which allows the editing of the time and date, mode 2 – 7 allows the editing of the time bands and mode 8 allows the editing of the relay time in trade mode (Note: mode 8 only appears in trade mode). The up/down buttons allow the underlined information to be edited (pressing these buttons once will change the value by one, holding the button down will auto increment the value until the button is released) and the select button allows the underline cursor to rotate round to the next item on the display. If the time clock is inadvertently left in programming mode it will automatically revert to standby mode after a preset time.

DISPLAY

Monday 15:20
15/01/02 GMT OFF

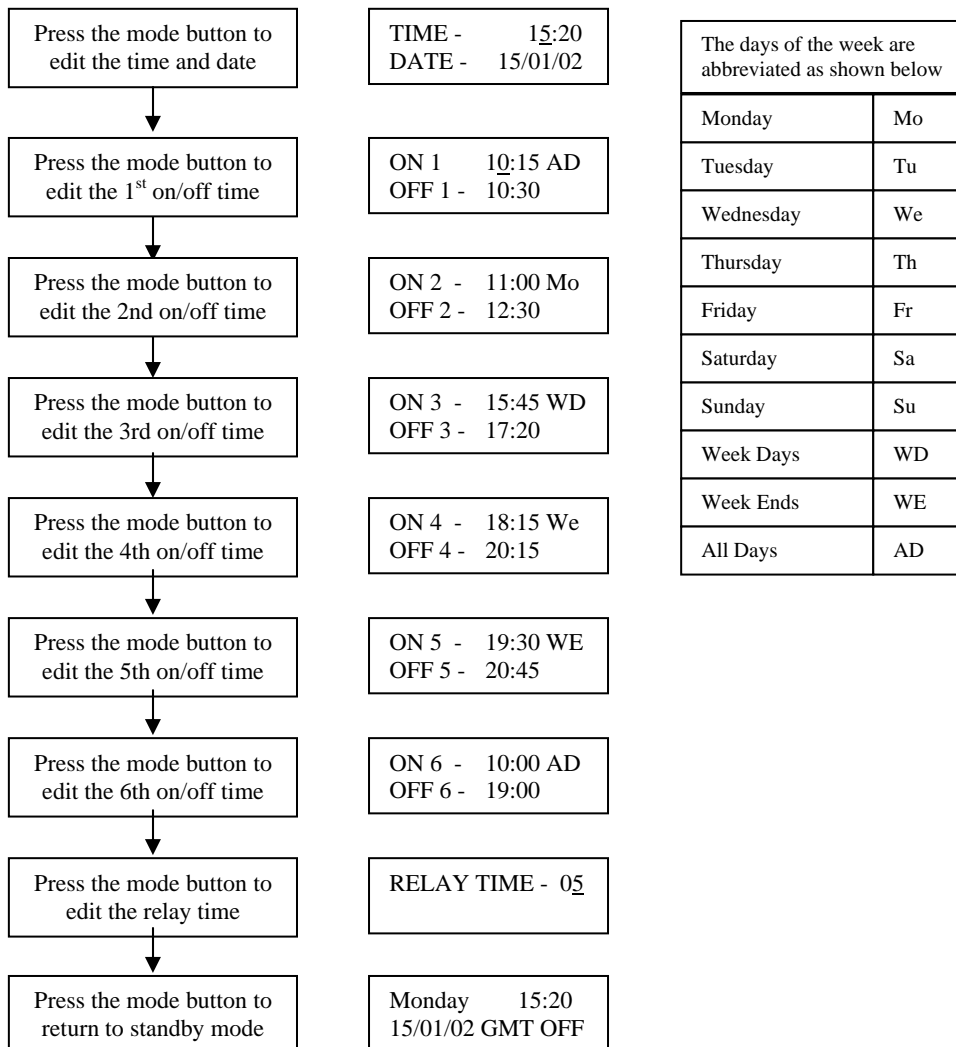

The days of the week are abbreviated as shown below	
Monday	Mo
Tuesday	Tu
Wednesday	We
Thursday	Th
Friday	Fr
Saturday	Sa
Sunday	Su
Week Days	WD
Week Ends	WE
All Days	AD

NOTE: To reset the time clock completely, simply power up with the UP button pressed

VX123 VIDEO SWITCHING PCB

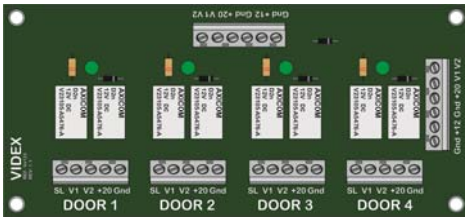

The VX123 is used on multiple door video systems to switch the video from a single door to the bus. Each PCB can control up to four video panels. Multiple PCB's can be used to expand the system. A green LED indicates when a panel is connected to the bus.

CONNECTION	FUNCTION
GND	0V
+12	12Vdc from PSU to power the PCB
+20	20Vdc switched to the relevant door when triggered
V1	+ Sync video signal switched to relevant door when triggered
V2	- Sync video signal switched to relevant door when triggered
SL	Trigger input to activate a channel (Switched 0V)

4 WAY ISOLATION PCB (2204N)

The 2204N will protect against shorts or faults on all connections to an apartment. Plug in connections are used for easy maintenance. The 2204N can also be connected as a bus in a prewired cabinet and is addressed using a 6 way dip-switch bank. For video systems there is an additional video isolation card (316I for non-coax or 894I for coax) which piggy backs this board and includes all the additional connections for video. There are 10 LED's on each card which can be used to identify when a channel is in use (Green channel LED on) and to indicate a variety of faults such as shorts on +12V out, short on bus and S1 permanently active.

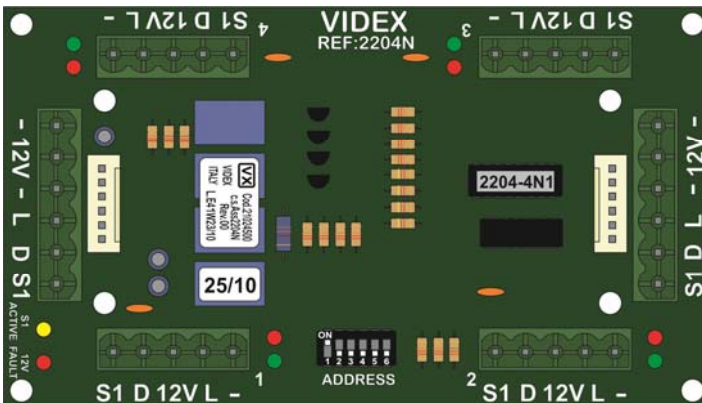

- Six way connectors – Main bus in/out
- Five way connectors – Four outputs to apartments.

Connection	Function
-	0V
L	Bus connection
12V	+12Vdc
D	Door open LED (Switched 12V)
S1	Spare service button on telephone (Switched 0V)













































LED	Function
D1	Bus fault output 1
D8	Bus fault output 2
D14	Bus fault output 3
D19	Bus fault output 4
D7	Output 1 active
D6	Output 2 active
D5	Output 3 active
D4	Output 4 active
D21	S1 service switch active
D3	12V out fault on one of the outputs

OPERATION

In stand-by the phones connected to the 2204N are physically disconnected from the main BUS. During a call the selected channel will be connected to the main bus, the green LED next to the channel will illuminate for the length of the call.

PROGRAMMING (DIP-SWITCHES)

The dip-switches are used to address the PCB. The address of the PCB must correspond with the address of the telephone in the apartment. For example, output 1 of the first 2204N must be connected to a telephone with address 1, output 3 must be connected to a telephone with address 3, Output 1 of the second 2204N must be connected to a telephone with address 5 etc. The table below shows all available addresses.

2204 no.	Addresses of:				2204 No.	Addresses of:				2204 No.	Addresses of:						
	DIP-SW Settings	Connected Intercoms				DIP-SW Settings	Connected Intercoms				DIP-SW Settings	Connected Intercoms					
	ON <input type="checkbox"/> OFF <input type="checkbox"/>	L1	L2	L3	L4		L1	L2	L3	L4		L1	L2	L3	L4		
0		1	2	3	4	16		65	66	67	68	32		129	130	131	132
1		5	6	7	8	17		69	70	71	72	33		133	134	135	136
2		9	10	11	12	18		73	74	75	76	34		137	138	139	140
3		13	14	15	16	19		77	78	79	80	35		141	142	143	144
4		17	18	19	20	20		81	82	83	84	36		145	146	147	148
5		21	22	23	24	21		85	86	87	88	37		149	150	151	152
6		25	26	27	28	22		89	90	91	92	38		153	154	155	156
7		29	30	31	32	23		93	94	95	96	39		157	158	159	160
8		33	34	35	36	24		97	98	99	100	40		161	162	163	164
9		37	38	39	40	25		101	102	103	104	41		165	166	167	168
10		41	42	43	44	26		105	106	107	108	42		169	170	171	172
11		45	46	47	48	27		109	110	111	112	43		173	174	175	176
12		49	50	51	52	28		113	114	115	116	44		177	178	179	180
13		53	54	55	56	29		117	118	119	120						
14		57	58	59	60	30		121	122	123	124						
15		61	62	63	64	31		125	126	127	128						

Technical specifications

Number of outputs : 4
 Addressing range : from 0 to 44
 Working temperature : -10 +50 C°
 12V output current max. : 200mA

BUS EXCHANGE DEVICES (2206N)

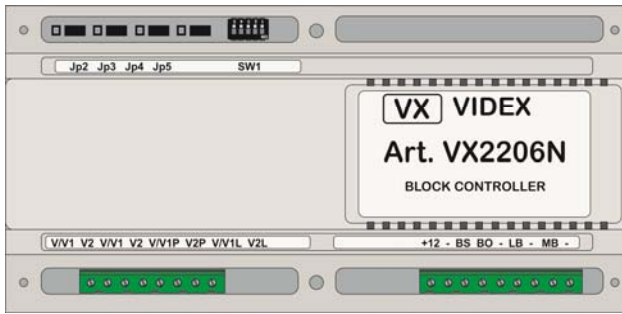

The 2206N is a powerful device which allows the system to be expanded up to 998 apartments. There are two applications in which this unit can be used.

The first application is a system with both main entrances and sub entrances/blocks (Main entrances call all apartments on a system and sub/block entrances only call the apartments in their own block). In this application, one 2206N would be required for each block.

The second application is a single level system with up to 10 entrances whereby all entrances need to call all apartments. In this application, a 2206N would be required for every 180 apartments and could be used to expand the system up to 998 apartments (i.e. 500 apartments would require a minimum of 3x2206N).

OPERATION

In stand-by mode:

The bus signal from the local entrance terminals “LB” and “-” are linked to the “BO” and “-” terminals (the “BUS out”), while the video signal of the “V1/V-L” and “V2-L” coming from the local entrances are sent to the video output terminals “V1/V-O” and “V2-O”.

During the call:

- When a call is from a main entrance, it sends serial data to communicate with a 2206N (Based on the 2206N’s address). If BS (Local busy) is high (12Vdc = Not busy)) on the 2206N, the call will be put through to the block, the system connects the “BUS Out ” (terminals “BO” and “- ”) with the “ Main BUS” (entrance terminals “MB” and “-”) and connects the video outputs “V1/V-O” and “V2-O” to the terminals “V1/V” and “V2”, connecting the main entrance with the user required. If the BS is low (0V), the local panel(s) already have a call in progress, then the main panel will receive a busy message and must wait until the local call ends.
- If a local call is made while a main entrance call is already in progress to that block, the local panel will get a busy message and must wait for that call to end.

CONNECTION	FUNCTION
+12	12Vdc supply input
-	0V from supply
BS	Busy connection to local entrances
BO	Bus output to apartments
-	0V to apartments
LB	Bus from local entrances
-	0V from local entrances
MB	Bus from main entrances
-	0V from main entrances
V/V1	V1 of balanced video or centre core of coax video from main entrances
V2	V2 of balanced video from main entrances (Not used in coax mode)
V/V1	V1 of balanced video or centre core of coax video loop through to next 2206N
V2	V2 of balanced video loop through to next 2206N (Not used in coax mode)
V/V1-P	V1 of balanced video or centre core of coax video powered loop through to next 2206N
V2-P	V2 of balanced video powered loop through to next 2206N (Not used in coax mode)
V/V1-L	V1 of balanced video or centre core of coax video from local entrances
V2-L	V2 of balanced video from local entrances (Not used in coax mode)
V/V1-O	V1 of balanced video or centre core of coax to apartments
V2-O	V2 of balanced video to apartments (Not used in coax mode)

NOTE: When using coax for the video, the screens should all be terminated together (and soldered) in a connection block.

JUMPERS

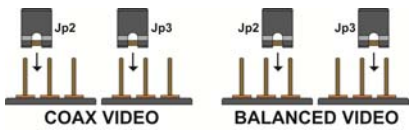

Jumpers JP2 and JP3 are used to set the video signal type to either balanced (Twisted pair) or coax (Composite video)

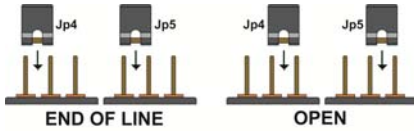

Jumpers JP4 and JP5 are used to terminate the video end of line. They should only be in the end of line position on the last 2206N

DIP-SWITCHES

Dip-switches 1 – 4 are used to address the 2206N. Each 2206N must have a unique address. The address will be used when programming the main entrance panels on a system. Dip-switch 5 should be set to ON if there are no local entrances connected to the 2206N and set to OFF if there are local entrances connected to it.

ENTRANCE PANEL
CONNECTED TO LB & -
(i.e. 2 level system)



NO ENTRANCE PANEL
CONNECTED TO LB & -
(i.e. 1 level system)

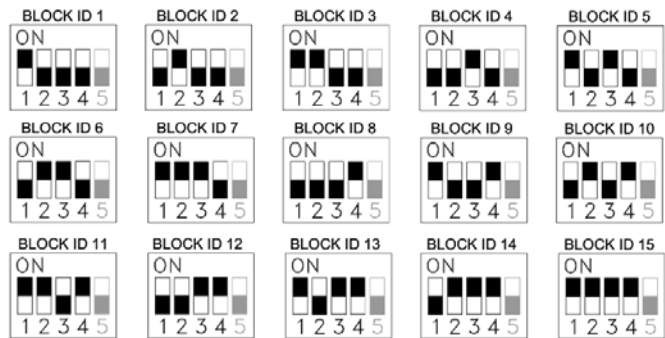

Technical specifications

Working voltage : 13 Vdc +/- 10%
Working Temperature : -10 +50 C°

CONCIERGE UNIT (2210A, 2210V)

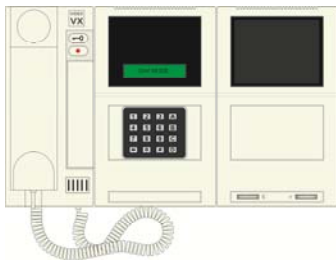

The Digital Concierge has an alphanumeric keypad (“0” to “9”, “*”, “#”, and “A” up “H” by means of four buttons with double letter function), a mode button (night, day, off) “●” and a door open button  and a 2 line 16 character LCD display with back light. This device enables the intercommunication between concierge and user, door and concierge, door and user and two users, the booking of up to 48 user calls and the storing of up to 48 user activated alarms. The video version is equipped with a



colour or monochrome flat screen monitor with brightness and contrast controls (brightness and colour on the colour version)

OPERATION

The mode button “●” switches the concierge between operating modes. There are 3 operating modes (off/night/day). To switch from one to another, press the button until a beep is heard and the message relevant to the current mode is shown on the display.

Off mode: The display shows “**OFF MODE**” and all functions of the unit are deactivated. The external calls will go directly to the user. The concierge cannot answer internal or external calls and cannot receive alarm signals.

Day position: The display shows “**DAY MODE**”. All calls are processed by the concierge and the operator can use all functions of the unit. The concierge can make and receive calls to and from the apartments and can receive and store all incoming alarms.

Night position: The display shows “**NIGHT MODE**”. Same operation as “DAY MODE” but the external calls go directly to the apartment with the exception of calls addressed to the concierge (calls made to apartment number with phone ID. “1”).

Calls from outdoor stations: the concierge rings, the monitor switches on and the displays shows “**D.X – APP:YYYYYY**” where X indicates the door from which the call originates and YYYYYY indicates the flat number of the called user.

- The operator can divert the call to the called user by pressing the “*” button for 2 seconds without picking up the handset (the display will show the message “**CONNECTED**”). Alternatively, pick up the handset and speaking to the visitor; the display shows “**SPEAK**” and then shows again the number of the called user. The operator can now take any of the following steps:
 1. Open the door by pressing the door opening button, display shows “**DOOR OPEN**”, an acoustic signal will be heard during the opening of the door, the conversation will end and the operator can replace the handset;
 2. call the requested user by pressing “*” (or type in an different apartment number and press “*”), the display shows “**CALLING**”, the video signal is forwarded to the called apartment (only for video installations), the outdoor station is put on hold and the operator can talk to the user who can then decide to take the call or not.
 - a) If the user accepts the call, the operator must press “*” again to transfer the call, the display shows “**CONNECTED**”, the user can talk to the visitor and the operator can replace the handset.
 - b) In case the user does not answer, the operator must press (for about 1 sec) “#” to return to the visitor. In case the user answers and replaces the handset, the operator will be automatically re-connected to the outdoor station.
- If the operator is absent or can't answer, the display will show the message “**P.X→FLAT:YYYYYY**” relevant to the last call received; to delete the message, the operator must to pick up the handset and press “#”.

The operator can stop the conversation between the visitor and the user at any time by picking up the handset and pressing “#”.

Call from an apartment:

The calls from the apartments are logged on the concierge and answered at the discretion of the operator but always in the order of receipt. When an internal call is received, the display shows the generic message “**CALL FROM FLAT**”, the concierge emits an acoustic signal (with different tone) and the operator can take the following steps:

1. Pick up the handset to start answering the booked calls;
2. The display shows the message “**FLAT:XXXXXX→CONC**” where “XXXXXX” is the flat number of the user who has booked the call;

3. The operator can delete the call by pressing “#” or call them back by pressing “*”:
 - a) If the operator chooses to delete the call, the concierge restarts from step (2) showing the next booked call (if there are other booked calls), otherwise it goes back to the stand-by condition (the display shows the message relevant to selected operation mode);
 - b) If the operator choose to take the call, the concierge calls the user;
 4. The display shows the message “**CALLING**”; if the apartment doesn’t answer, the operator can replace the handset and restart from step (1). If the apartment answers, the display will show the message “**SPEAK**”; operator and user are connected and the apartment can choose to close the conversation or to ask the operator to be connected with another apartment (intercommunication):
 - a) If the apartment replaces the handset, the conversation ends; if there are other calls to answer (the concierge rings) the operator can restart from step (1) otherwise the concierge will return to the stand-by condition;
 - b) If the apartment requests intercommunication with another apartment, the operator must enter the apartment number requested on the keypad and then press “*”;
 5. When two users are connected, the display shows the message “**INTERCOM.**” and the operator can replace the handset. As soon as the conversation ends, the concierge goes back to the stand-by condition. The intercommunication can be interrupted at any time by the operator picking up the handset and pressing “#”.
 6. If there are other booked calls (the concierge rings) the operator can restart from step (1) otherwise the concierge will go back to the stand-by condition.
- Any conversation in progress can be interrupted at any time by an external call (External calls take priority).

Call from the Digital Concierge to the apartment

The operator can contact any apartment from the concierge by picking up the handset, entering the relevant apartment number and pressing “*”;

1. the display shows “**CALLING**”;
2. if the user answers, the display will show “**SPEAK**”. If the user doesn’t answer, the operator can end the call by replacing the handset.

The communication can be interrupted at any time by an external call (External calls take priority).

Receiving alarms from an apartment

The concierge can receive and store up to 48 alarms from the apartments.

1. the concierge starts to emit an acoustic signal on every alarm received and at the same time the display shows the message “ALARM” until the operator clears all alarms;
2. to clear the received alarms, the operator must press for 1sec “A” without picking up the handset; then the display will show the message “**ALARM:XXXXXX**” on the first row and the message “**N:YY**” on the second row where “XXXXXX” is the flat number where the alarm has been generated and “YY” is the number of alarms to clear including the one shown.

When “YY” = 1 (last alarm), the concierge stops emitting the acoustic signal; press “A” again and the concierge will return to stand-by mode.

OPERATION NOTES

- a. To use the letters “E” to “H” press the relevant button twice: “A” becomes “E”, “B” becomes “F”, “C” becomes “G” and “D” becomes “H”;

Opening the speech from the concierge to a door station without being called first: With the concierge in DAY or NIGHT mode, pick up the handset, select a number from 1 – 9 (For doors addressed from 1 – 9) and then press “●”. The display will show ‘SPEAK’ once the speech path has been established.

Opening a door from the concierge without being called first With the concierge in DAY or NIGHT mode, pick up the handset, select a number from 1 – 9 (For doors addressed from 1 – 9) and then press the “” button. The display will show ‘DOOR OPEN’.

DIP-SWITCHES

Switch	Status	Operation
1	ON	Divert a call address 180 if the call is not answered within 20 seconds.
2	ON	Enable parallel connection of 2 concierges. This switch must be “ON” for Both concierges.
3	ON	Enable the use of Art.2204N isolation PCB’s.
4	ON	Disable alarms. Alarms can instead be processed by one or more Art.512DR if installed in the system and addressed as 255.

TRIMMERS

Two POT's are also located within the concierge. The one to the right of the PCB adjusts the speech balance towards the apartments and the one to the left adjusts the speech balance towards the doors.

PROGRAMMING

The concierge has two main operational modes (Main and standard). Main mode is only used on systems which include 2206N devices. Standard mode is used for all other system types. To switch the system into main mode power up with '0' pressed, to switch to standard mode power up with '#' pressed
 Programming can be carried out using the concierge keypad and display as shown in the flowchart below or via a PC connected to the jack socket on the top edge of the concierge.

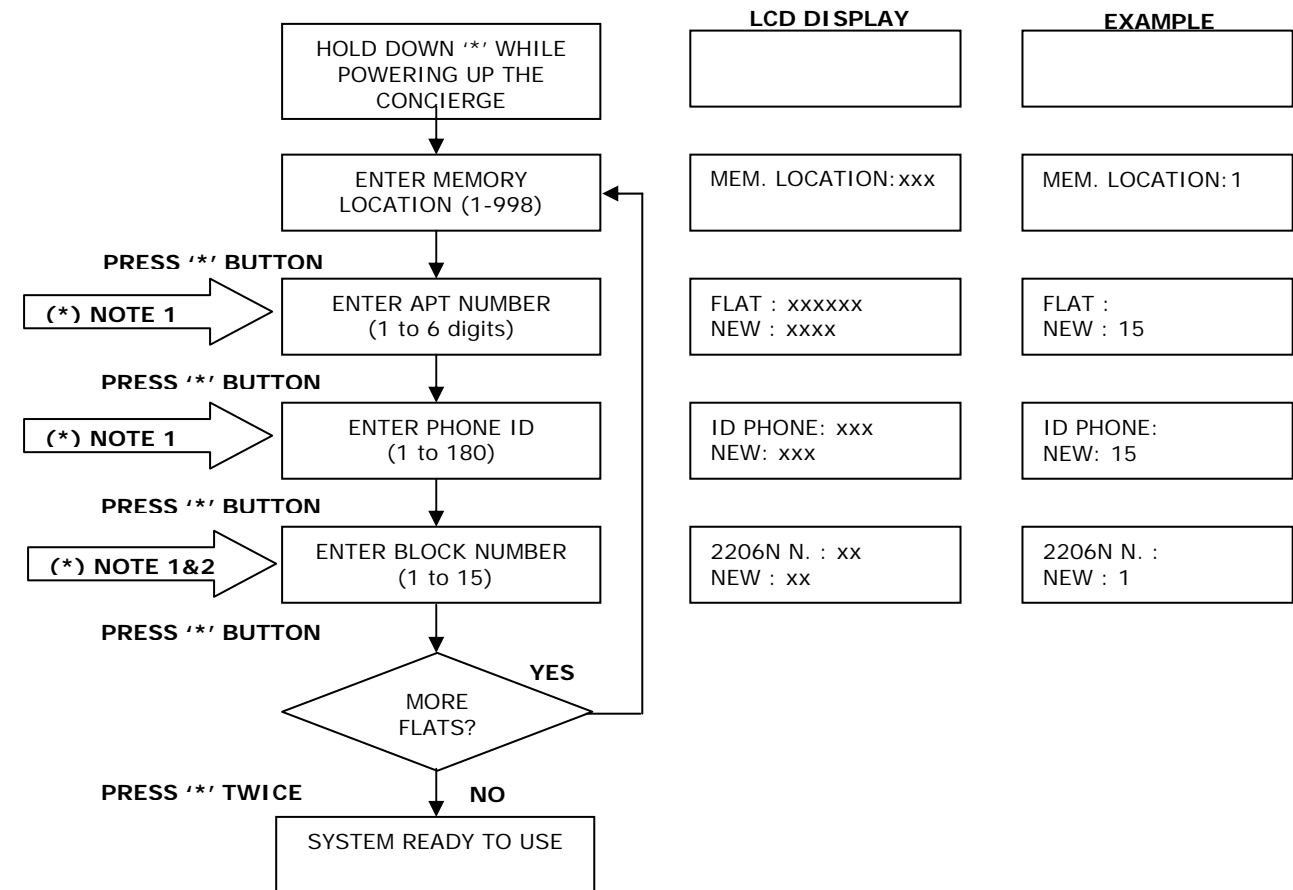

NOTES:

- (*) NOTE 1 → To confirm the same value press '*' twice.
- (*) NOTE 2 → This only appears when the concierge is in main mode.

PROGRAMMING NOTES

- a. The programming (combining the phone ID address and the apartment number) must be the same as digital door units or must correspond to the call button on the functional units in order to have the correct flat number on the concierge display.
- b. During the programming, the system is off line and no calls will go through;
- c. The insertion of incorrect values is indicated by error messages. The unit will wait for a correct input before moving on.
- d. When programming via the PC software the concierge must be in **OFF** mode. Follow the instructions supplied with the PC software (Note. Follow the same procedure to program the Concierge as would be used to program a digital door panel).

TECHNICAL SPECIFICATION

Memory capacity : 998 memory locations
 Working voltage : 13 Vdc +/- 10%
 Max. absorption : about 350 mA
 Working temperature : -10 +50 C°

2280 BUS INTERFACE

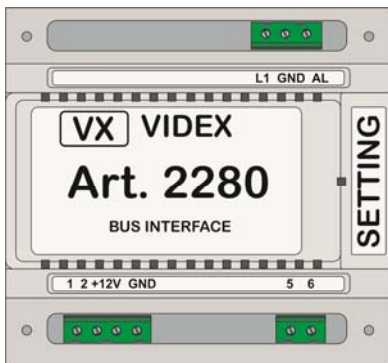

The Art.2280 enables the connection of either the Videx Telephone Interface (Art.380) or the Videx apartment station (Art.500MM) to the VX2200 system.

Using this device it is possible to carry out all the functions available on the VX2200. For example, answer a call from the door panel (and if necessary open the door), call the concierge (if present on the system) and intercommunicate with another user (via concierge).

The system draws power directly from the "2 wire" Bus (Less than 0.8mA) and from either the 380 or the apartment station power supply (12Vdc). It includes an 8 way Dip-switch for programming the device with the phone ID address and a trimmer control for the audio volume towards the door panel.

It is possible to connect up to 180 devices on the same "2 wire" Bus, with the possibility to use the same address for a maximum of 3 devices (for those applications that require more than one unit in the same apartment). Use VX2280 version with 900 series and VX2280-1 with 3000 series.

OPERATION

To answer a call:

Art.380 → Pick the handset up and speak with the visitor or concierge; press the relevant button to open the door (see 380 manual) and/or replace the handset to end the conversation.

Art.500MM → Press the "TALK" button to speak with the visitor or concierge, release the button to listen, press the "OPEN" button to open the door and then wait for the time-out to end the conversation.

To call the concierge (if present):

Art.380 → Pick the handset up, press the relevant button to open the door (see 380 manual) and wait for an answer.

Art.500MM → Press the "TALK" button, press the "OPEN" button and wait for an answer.

PROGRAMMING

Remove the "Settings" cover from the device, set the 8 way Dip-switch with the required address. In case of mismatched audio level (towards the outdoor station), adjust the trimmer next to the Dip-switch.

TECHNICAL SPECIFICATION:

Addressing range	: from 1 to 180
Working voltage	: Bus line voltage and 12V
Stand by absorption/maximum on the BUS	: <0.8mA and approx 10mA
Stand by absorption/maximum on the 12V	: Approx. 5mA
Working temperature	: -10 +50 °C

Audio Telephones (3171, 3172 & 3176)

The Art.3171 is a digital intercom based on the “**2 Wire BUS**”, it includes a door-open button and a service button plus an electronic call tone with a 3 level volume control which can be adjusted by the user. Internally, the intercom has an 8 way dip-switch to set the PHONE ID, terminals for connecting to the bus and other functions and a trimmer (VR1) to adjust the microphone volume. It is possible to connect up to 180 intercoms on the same bus. The same address can be given to a maximum of 3 devices (for applications that require more units in the same apartment). The door-open push is also the “call to concierge” (if present), while the “●” push button shorts terminals “**SW SW**” (Max 30Vac/dc 200mA) when pressed.

The Art.3172 is the same as the Art.3171 with the addition of a privacy switch.

The Art.3176 is similar to the Art.3172 but the privacy function is activated by pressing **X**. It is signalled by the red led “privacy on” and its duration is set on the 3 way dip-switch (housed inside the intercom). The Art.3176 doesn't have the service push button but it has a green “door open” led to give the user a visual indication of whether the door is open or closed: to use this service, an additional wire is required from a door contact to the intercom.

All 3 models of intercoms allow the connection of an optional relay board Art.402, for the activation of an external sounder instead of the internal one: the board is housed inside the intercom, connected to the **JP2** (red wire on “+” side) and the **JP1** jumper (normally on A position) must be moved to the “B” position.

3171

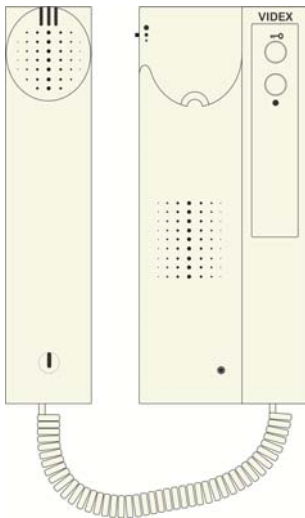

3172

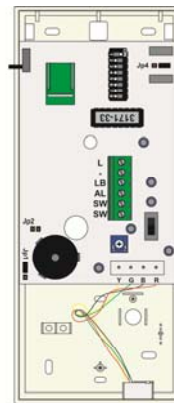
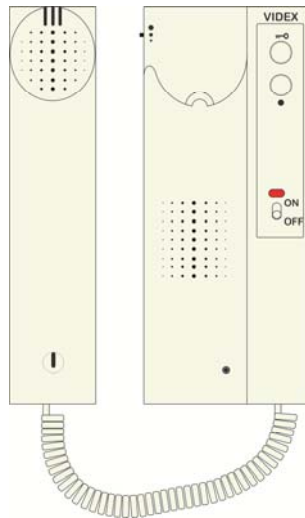

	FUNCTION
L	Bus
-	0V
LB	Local door bell (Switched 0V)
AL	Alarm input (Switched 0V)
SW	One side of service button
SW	Other side of service button
JP4	Number of rings Right = 3 Left = 6

3176

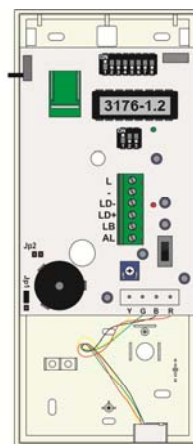
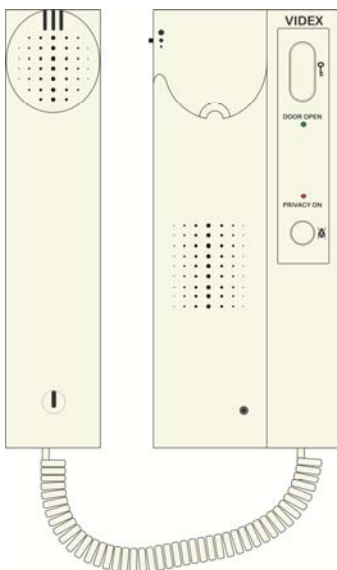

	FUNCTION
L	Bus
-	0V
LD-	0v connection of door open LED
LD+	12Vdc connection of door open LED
LB	Local door bell (Switched 0V)
AL	Alarm input (Switched 0V)

OPERATION



To answer a call and open the door: Pick the handset up and speak with the visitor (or concierge); press the ‘’ button (if it is an external call) to open the door (an acoustic signal will be emitted and the door will be opened for the time programmed) or replace the handset to end the conversation; if the call is local (local bell), the call tone will have a different tone.

To call the Concierge Unit (if available): With the handset replaced, press the “” button and wait: A confirmation tone will be heard, the call is booked on the concierge and will be answered at the discretion of the operator.

To activate the service relevant to the  push button (except the Art.3176): It is possible to use this push button as an “alarm” push button: make a short between one of the “**SW**” terminal and the “-” terminal and then connect the free “**SW**” terminal to the “**AL**” terminal. The signal generated will be received by the concierge and/or by the Art.512DR to activate an additional service.

PROGRAMMING

To select the desired melody (3171 & 3172 only): Hold down “” button until (Approx. 10 seconds) the intercom plays the active melody; at the end of the melody the intercom will emit a beep (end of play);

1. Listen to the available melodies (by pressing and releasing the “” button).
2. After the ‘end of play’ beep if you don’t press the “” button within 3 seconds, the last melody heard is selected.

To switch ON the privacy mode:

For the Art.3172 put the switch into the ON position. The small window over the switch will be RED.

For the Art.3176 press the push button marked ; the red LED “privacy on” will illuminate.

To switch OFF the privacy mode:

For the Art.3172 put the switch into the OFF position. The small window over the switch will be WHITE.

For the Art.3176 press the push button marked ; the red LED “privacy on” will switch off.

ID programming is carried out by setting the internal 8 way dip-switch to the positions shown on the decimal/binary conversion table of this manual.

The Art.3176 also has an additional 3 way dip-switch to set the duration of the privacy time as follows:

DIP SWITCH S1			Time	DIP SWITCH S1			Time
1	2	3		1	2	3	
off	off	off	unlimited	off	off	on	2 hours
on	off	off	15min	on	off	on	4 hours
off	on	off	30min	off	on	on	8 hours
on	on	off	1hour	on	on	on	16 hours

Technical Specifications

Addressing range : from 1 to 180 (BIN code)

Working voltage : BUS line Voltage

Stand-by absorption : about 0.6 mA

Phone max. absorption : about 80mA

Working temperature : -10 +50 C°

AUDIO APARTMENT STATION (5178)

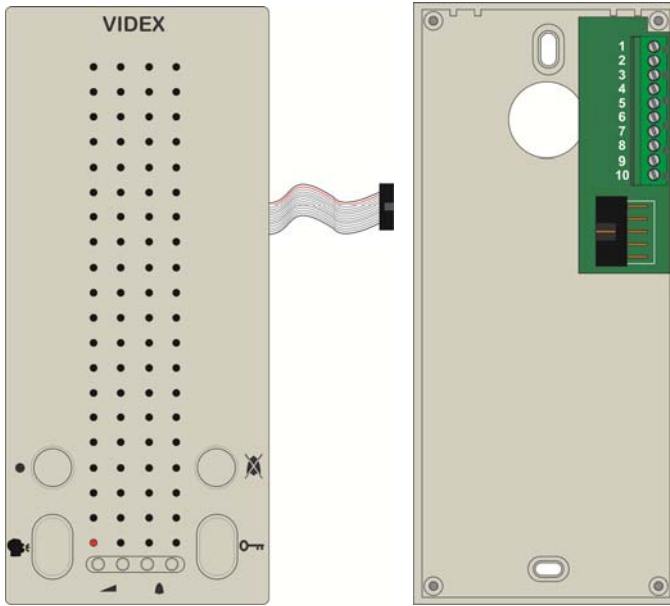

The 5178 is an audio apartment station available in white, silver or carbon fibre ABS plastic and is a surface mount unit which connects to the VX2200 bus via a 4 wire bus. The apartment station has half duplex speech (Hands free speech) and the facility to switch into simplex speech mode by holding the talk/answer button down during a call. The apartment station includes the following buttons.

PUSH BUTTONS, LED'S AND CONTROLS	
●	Service push button - When pressed, shorts terminal "S1" to terminal "GND" (ground).
📞	Answer - On an incoming call, operation of this button allows the user to answer and converse with the visitor. The LED next to the button will illuminate.
	Switch off - With the system switched on (Call in progress), momentary operation of the button will switch the apartment station off. The apartment station will also automatically switch off after a time delay if the button is not pressed. The LED next to the button will go off.
	Simplex button - Pressing and holding the button for more than 3 seconds will switch the apartment station into SIMPLEX speech mode. Press and hold the button to speak to the caller (The LED next to the button will flash rapidly), release the button to listen (The LED will flash slowly). If the button is not pressed for 10 seconds the apartment station will switch off. The apartment station will revert to half duplex speech when another call is made.
✕	Privacy on-off - enable/disable the service. The LED next to the button will illuminate when the privacy service is enabled.
🔑	Concierge call - While in standby, press this button to call the concierge (If service is available).
	Door open - During a call, operation of this button will activate the "door open"
	Calltone volume controls - 3 levels available. Press the left key to decrease volume and the right to increase volume.
🔔	Choose calling melody - 9 melodies available. See programming section for operation of these buttons.

Description	Signal	Terminal
One side of the ● service button	SB	1
Door open & AUX LED ground	-LD	2
+12V dc input to power the apartment station	+12V	3
0V supply input and bus ground	GND	4
Bus line (Data/speech)	L	5
Local door bell input (Triggered by 0V)	LB	6
Alarm button input (Triggered by 0V)	AL	7
Other side of the ● service button	SA	8
AUX LED +12V input	AUL	9
Door open LED +12V input	DOL	10

PROGRAMMING

Programming is carried out by setting the internal 8 way dip-switch to the positions shown on the decimal/binary conversion table of this manual.

PROGRAMMING THE MELODY

- Press and hold the two melody buttons "🔔" (for approx 10 seconds) until the unit plays the current stored melody and emits a beep.
- Press the melody button again (left or right) to listen to the available melodies (maximum 9).
- When the chosen melody has been reached, do not press any buttons, wait 3 seconds for the exit beep.
- The new melody is now stored.

PROGRAMMING NUMBER OF RINGS (FACTORY SET 6 RINGS)

- Press and hold “☎” (for approx 10 seconds) until the unit emits a beep.
- Press “☎” as many times as the number of rings required (i.e. 6 presses = 6 rings with a maximum of 9 rings)
- Once the number of rings required has been reached, wait 3 seconds for the exit beep.
- The new value is now stored.

PROGRAMMING THE PRIVACY DURATION (FACTORY SET WITH OUT TIMEOUT)

- Press and hold “X” (for approx 10 seconds) until the unit emits a beep.
- Press “X” again to set the privacy duration. Each time the button is pressed, it will increase the privacy duration by 15 minutes (starting from 0 up to a maximum of 20 hours i.e. pressing the button 8 times = 2 hours up to a maximum of 80 presses for 20 hours). Once the required privacy duration has been reached, wait 3 seconds for the exit beep. To set the privacy with no time out Press and hold “X” (for approx 10 seconds) until the unit emits a beep do not press any other button, wait 3 seconds for the exit beep.
- The new value is now stored.

RESTORE FACTORY DEFAULTS

- Power up the intercom keeping pressed “☎”;
- The intercom will emit a beep to confirm the operation;
- Release “☎”.

TECHNICAL SPECIFICATION

Addressing range	: from 1 to 180 (BIN code)
Working voltage	: 12Vdc
Stand-by absorption	: about 6mA
Phone max. absorption	: about 50mA
Working temperature	: -10 +50 C°

VIDEOPHONES

3371(Mono) 3471(Colour)

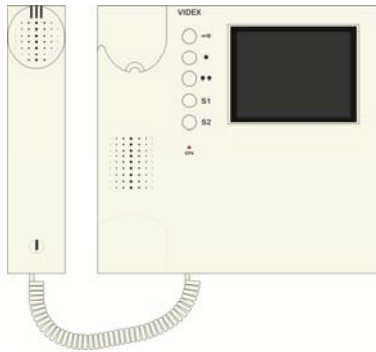



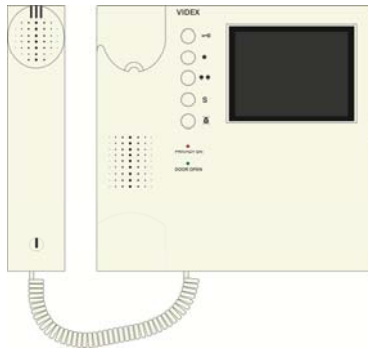



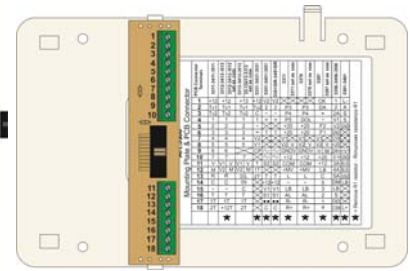





3376(Mono) 3476(Colour)



3980 (Back plate)



The Art.3371 (3471 colour) is a digital videophone based on a “6 Wire BUS”, it includes 5 push buttons as shown in the table below and the images above. The call is an electronic tone with a 3 level volume control which can be adjusted by the user. To connect the videophone to the “BUS”, use the PCB connector provided with the mounting plate Art.3980. The videophone has an 8 way dip-switch to set the PHONE ID, a 5 way dip-switch to set the video system (coax or non coax) and a trimmer (VR1) to adjust the microphone volume; all accessible from the rear of the videophone. It is possible to connect 180 videophones to the same system and if necessary it is possible to give the same address to a maximum of 3 (for those applications that require more units in the same apartment. It is also necessary to add additional video splitters and PSU's). The Art.3376 (3476 colour) have one less service button than the Art.3371 but has a timed privacy button, privacy LED and a door open LED.

PUSH BUTTONS, LED'S AND CONTROLS	
	Door open - During a call, operation of this button will activate the “door open” Concierge call- While in standby, press this button to call the concierge (If service is available).
	Set to Camera recall – Press this to recall the door panel camera image. Press it the number of times as the door number to recall. For example, press 3 times to recall door 3. Set to alarm – Pressing this button will send an alarm signal to the concierge and or any 512DR's address to 255.
	SPARE SERVICE BUTTON
	SPARE SERVICE BUTTON
	SPARE SERVICE BUTTON
	Privacy on-off - enable/disable the service. The PRIVACY ON LED will illuminate when the privacy service is enabled.
	RED LED- Indicates the monitor is switched on during a call
	RED LED- Privacy is enabled
	GREEN LED- Indicates when the door has been released
	Call tone volume control – 3 levels available.
	Picture brightness
	Picture contrast

OPERATION

To answer a call and open the door: Pick up the handset and speak with the visitor (or concierge); press “” (if it is an external call) to open the door (an acoustic signal will be emitted and the door will open for the time programmed) or replace the handset to end the conversation; if the call is local (local bell), the call tone will have a different tone.

To call the Concierge Unit: With the handset replaced, press “” and wait: a confirmation tone will be heard; the call is booked on the concierge and will be answered at the discretion of the operator;

To activate the privacy mode (Art.3376 only)

Press the push button labelled , the red “privacy on” LED will switch on. To disable the privacy mode before the configured time expires, press the same push button again.

CONNECTIONS

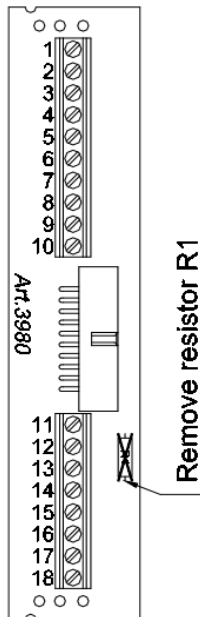

Art.3371 – Description of the signals on the Art.3980 back plate		
	Set as non-coax	Set as coax
1	Not used	
2	P3 – Push button ●● shorts to COM when pressed	
3	P4 – Push button S ₁ shorts to COM when pressed	
4	P5 – Push button S ₂ shorts to COM when pressed	
5	+20 - +20Vdc monitor power supply	
6	+20 - +20Vdc monitor power supply	
7	V1 (balanced video signal sync-)	
8	V2 (balanced video signal sync+)	
9	GNDV Ground reference for video signal	
10	+12 - 12Vdc output for coax video distributor Art.894 power supply ¹	
11	COM - Common terminal for P3, P4 and P5	
12	+MV - +12Vdc input for powering memory board ²	
13	L (Bus Data line)	
14	- (Bus data line GND)	
15	LB - Local bell input (Switch 0V input)	
16	AL - Alarm signal input (Switched 0V input)	
17	R-,R+ - Connection terminal for the additional relay board Art.402 (black wire to terminal R-, red wire to terminal R+)	
18		

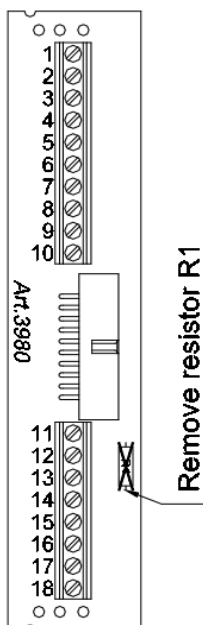

Art.3376 – Description of the signals on the Art.3980 back plate		
	Set as non-coax	Set as coax
1	Not used	
2	P3 – Push button ●● shorts to COM when pressed	
3	P4 – Push button S ₁ shorts to COM when pressed	
4	DOL - Door open LED signal (+12Vdc 5mA signal)	
5	+20 - +20Vdc monitor power supply	
6	+20 - +20Vdc monitor power supply	
7	V1 (balanced video signal sync-)	
8	V2 (balanced video signal sync+)	
9	GNDV Ground reference for video signal	
10	+12 - 12Vdc output for coax video distributor Art.894 power supply ¹	
11	COM - Common terminal for P3 and P4	
12	+MV - +12Vdc input for powering memory board ²	
13	L (Bus Data line)	
14	- (Bus data line GND)	
15	LB - Local bell input (Switch 0V input)	
16	AL - Alarm signal input (Switched 0V input)	
17	R- (17),R+ (18) - Connection terminal for the additional relay board	
18	Art.402 (black wire to terminal R-, red wire to terminal R+)	

Notes

¹ The voltage is available when the monitor is switched on and is normally only used on coax video systems.

² Only for monitors with memory board Art.35xx.

PROGRAMMING

The programming of this videophone consists of the following stages:

- Set the PHONE ID on the 8 way dip-switch shown on decimal/binary conversion table in this manual;
- Set the video format, coax or balanced (non-coax). As shown in the table below:-

SWITCH	1	2	3	4	5
Non-Coax (Balanced Video)	OFF	ON	ON	ON	ON
Coax (Composite video)	ON	OFF	ON	ON	ON

When connecting two or more videophones in series without the use of video distributors dip switches 3 & 5 should only be switched on at the end of line.

- Setting of the number of rings; the default setting is 3, to set 6 rings follow these steps:
 - a. switch off the videophone by unplugging the flat cable from the PCB connection;
 - b. make a short between terminals 14 and 15 (signals "-" and "LB") of the PCB connection;
 - c. plug the flat cable onto the PCB connection and wait for a double beep before removing the short between terminals 14 and 15;
 - d. to revert to 3 rings, do the same but wait for only one beep before removing the short between terminals 14 and 15.
- Setting the "●" button function; the default function setting for this push button is the camera recall, to set the push button as an alarm call:
 - a. Switch off the videophone by unplugging the flat cable from the PCB connection.
 - b. While pressing the "●" push button, plug the flat cable onto the PCB connection and wait for a double beep before release the push button.
 - c. To revert to the recall function, do the same but wait for only one beep before release the push button.

When you use the Art.402 for both Art.3371 and 3376, the fourth switch on the 5 way dip-switch should be moved to OFF.

The wires of the Art.402 must be connected; black to terminal 17 (R- signal), red to terminal 18 (R+ signal).

For the Art.3376 it is necessary to set the duration of the privacy mode by setting the **3 way dip-switch** (accessible from the rear side of the videophone) as shown on the table below.

3376 (3476) 3 WAY DIP-SWITCH FOR PRIVACY TIME

Dip-Switch			Time
1	2	3	
off	off	off	unlimited
on	off	off	15min
off	on	off	30min
on	on	off	1hour
off	off	on	2 hours
on	off	on	4 hours
off	on	on	8 hours
on	on	on	16 hours

TECHNICAL SPECIFICATION

Addressing range : from 1 to 180 (BIN code)
 Stand-by absorption : about 0.6mA
 Videophone max. absorption : about 400mA (20 Volt)
 Working temperature : -10 +50 C°

Video monitor (5478, 5476)

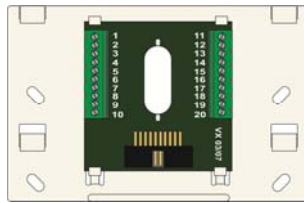
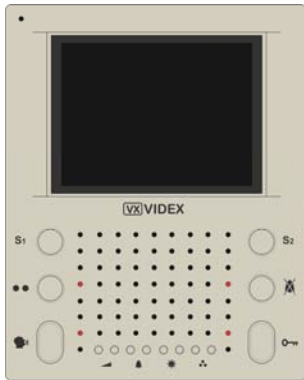

An intelligent Hands-free (surface or flush mounting) video monitor employing a colour 3.5" active matrix LCD display. The 5478 is available in white, silver and carbon fibre finishes and can be fitted with the optional flush kit or handset kit.

The 5478 includes push buttons for "door open/concierge call", "answer/camera recall", "privacy on/off", "Latching relay activation" and 2 service buttons plus 4 LED's associated with the 4 main buttons. In addition to the above, the unit has also controls for loudspeaker volume, call tone volume, brightness and hue with programmable number of rings, privacy duration and melody.

The buttons and LED's have the following functions:-

S1	<i>Service push button - When pressed, shorts terminal 12 "S1" to terminal "GND" (ground). (Max 24Vdc 50mA)</i>
● ●	<i>Latching output – Each time this button is pressed it will toggle terminal 14 between ground and open collector. The LED next to the button will illuminate when the output is grounded</i>
👤	<i>Answer button - On an incoming call, operation of this button allows the user to answer and converse with the visitor. The LED next to the button will illuminate.</i>
	<i>Camera recall button - Press as many times as the DEVICE N. of the door station to switch on.</i>
	<i>Switch off button - With the system switched on (monitor on), momentary operation of the button will switch the video monitor off. The videomonitor will also automatically switch off after a time delay if the button is not pressed. LED 2 will switch off.</i>
	<i>Simplex button - Pressing and holding the button for more than 3 seconds will switch the videomonitor into SIMPLEX speech mode. Press and hold the button to speak to the caller (The LED will flash rapidly), release the button to listen (The LED will flash slowly). If the button is not pressed for 10 seconds the videomonitor will switch off. The videomonitor will revert to duplex speech when another call is made.</i>
S2	<i>When pressed, shorts terminal 13 "S2" to Terminal "GND" (ground). (Max 24Vdc 50mA)</i>
✕	<i>Privacy on-off button - Press to enable/disable the service. The LED next to the button will illuminate when the privacy service is enabled.</i>
🔑	<i>Concierge call button – While in standby, press this button to call the concierge (If service is available).</i>
	<i>Door open button - During a call, operation of this button will activate the door.</i>
🔊	<i>Loudspeaker volume control</i>
🔔	<i>Call tone volume control</i>
☀️	<i>Brightness control</i>
●●●	<i>Colour intensity control</i>

Terminal	Signal	Description
1 & 2	+20V	Video power supply input 17-20Vdc
3 & 4	GND	Video power ground connection
5	V2/V	Balanced video V2 input or coax centre core (Set by 4 way dip-switches)
6	V1	Balanced video V1 input
7	L	Data/speech bus input
8	GND	Bus ground
9	LB	Local door bell input (Switched to ground to trigger)
10	AL	Alarm button input (Switch to ground to trigger)
11	GND	Ground
12	S1	S1 push button (Shorts to Ground when pressed)
13	S2	S2 push button (Shorts to Ground when pressed)
14	●●	●● push button (Latching toggle action)
15	+VD	+12Vdc output to power video distribution unit (Art. 894)
16	GND	Ground
17	12VO	Regulated 12Vdc output
18	12VI	+12Vdc power supply input

19	LD	Auxiliary LED +12V input (LED next to door open button)
20	GND	Ground



PROGRAMMING

Setup is carried out using the push buttons on the front of the unit and the dip-switches located on the rear of the unit. An eight way dip-switch bank is used to set the address of the apartment as shown in the decimal/binary conversion chart in this manual. Additionally there is a 4 bank dip switch which is used to select the video type (either coaxial or balanced video twisted pair).



4 WAY DIPSWITCH				Video Mode
1	2	3	4	
ON	ON	OFF	ON	Coaxial video (V2 = V, GND = Screen)
ON	ON	ON	OFF	Balance video (V1 & V2)

Switches 1 and 2 adjust the video signal impedance. When using more than one video monitor in series without a video splitter put both switches in the OFF position on all but the last video monitor (end of line).





Number of rings (Factory default = 6 rings)

- Press and hold (for approx 10 seconds) “” until the LED next to the button illuminates and the unit emits a beep.
- Press “” again as many times as the number of rings required (i.e. 6 times = 6 rings, maximum 9 times).
- Once the value of rings has been reached, wait 5 seconds for a beep and the LED turning OFF.
- The new value is stored.

Privacy duration time (Factory default = No time out)

- Press and hold (for approx 10 seconds) “” until the LED next to the button illuminates and the unit beeps.
- Each time the “” button is pressed; it will increase (starting from 0) the privacy duration by 15 minutes.
- Press until the required duration has been reached, when reached, wait 5 seconds for a beep and the LED turning OFF.
- The new time will be stored.
- To set the privacy with no time out (privacy enabled or disabled only by pressing the “” button), don't press any buttons once in privacy programming mode and wait 5 seconds for the beep and LED to go off.

Call tone melody (Factory default = melody 1)

- Press and hold “” (or “” on the SL5478) for approx 10 seconds until the LED next to the button illuminates and the unit plays the current programmed melody.
- Press again “” (or the “” on the SL5478) to listen to the available melodies (9 Available). Once the chosen melody has been reached, wait 5 seconds for a beep and the LED turning OFF.
- The new melody will be stored

Video monitor (SL5478)

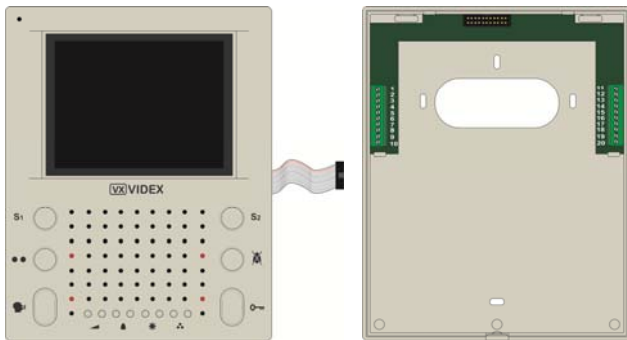

The SL5478 is a slimline version of the 5478. This model is surface mount only and unlike the 5478 does not require a separate mounting plate. Connections, programming, and functions are the same as the 5478 with the exception of the “●●” button which is non-latching on the SL5478. The “0” button is also used instead of the “●●” button when programming the call tone melody. The 4 way dip switch is also different to the 5478 as shown below.

4 WAY DIPSWITCH				
1	2	3	4	Video Mode
ON	OFF	ON	ON	Coaxial video (V2 = V, GND = Screen)
OFF	ON	ON	ON	Balance video (V1 & V2)



TECHNICAL SPECIFICATION

Addressing range : from 1 to 180 (BIN code)
 Stand-by absorption : approx 12mA standby on 12V input
 Call absorption : approx 70mA max on 12Vdc input (During a call)
 : approx 250mA max on 20Vdc input (During a call)
 Working temperature : -10 +50 C°

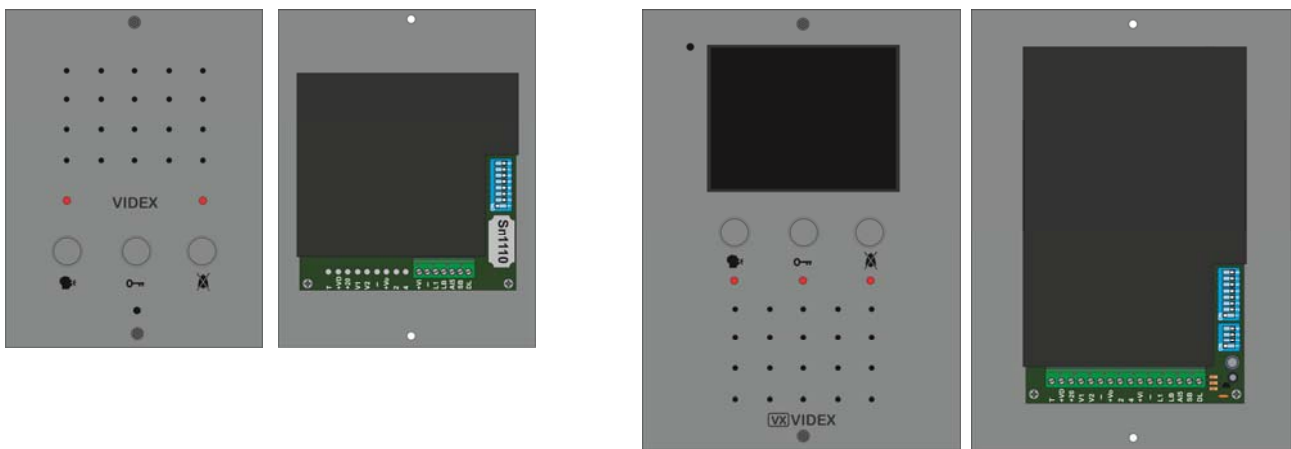
Video monitor (VR5178, VR5478)



The VR5178 is a vandal resistant flush mount audio apartment station in 12 gauge stainless steel which connects to the VX2200 bus via a 4 wire bus. The apartment station has half duplex speech (Handsfree speech) and the facility to switch into simplex speech mode by holding the talk/answer button down. The VR5478 also included a 3.5” TFT OSD monitor.

PUSH BUTTONS	
	Answer button - On an incoming call, operation of this button allows the user to answer and converse with the visitor. The LED next to the button will illuminate.
	Switch off button - With the system switched on (Call in progress), momentary operation of the button will switch the apartment station off. The apartment station will also automatically switch off after a time delay if the button is not pressed. The LED next to the button will go off.
	Simplex button - Pressing and holding the button for more than 3 seconds will switch the apartment station into SIMPLEX speech mode. Press and hold the button to speak to the caller (The LED next to the button will flash rapidly), release the button to listen (The LED will flash slowly). If the button is not pressed for 10 seconds the apartment station will switch off. The apartment station will revert to duplex speech when another call is made.
	Privacy on-off button - Enable/disable the service. The LED next to the button will illuminate when the privacy service is enabled.
	During a call, this button acts as a menu button to enter programming mode.
	Concierge call button - While in standby, press this button to call the concierge (If service is available).
	Door open button - During a call, operation of this button will activate the door.

Description	Signal
NOT USED	T
+12V output to power 894 video splitter	+VD
+15-20dc input to power video monitor	+20
Balanced video signal 1	V1
Balanced video signal 2 or coax centre core	V2
Video ground	-
+12V output (Max 100mA)	+Vo
NOT USED	2
NOT USED	4
+12V input	+VI
Bus 0V	-
Bus line	L1
Local door bell input (Active low)	LB
Alarm input (Active low)	AL5
Service button output (Open collector) Triggered by holding  for more than 3 seconds	SB
Door monitoring LED input (+12Vdc to trigger)	DL

PROGRAMMING

Address programming is carried out by setting the internal 8 way dip-switch to the positions shown on the decimal/binary conversion table of this manual.



The four way dip-switch sets the video signal type accepted by the monitor as shown in the table below:-

4 WAY DIPSWITCH				Video Mode
1	2	3	4	
ON	OFF	ON	ON	Coaxial video (V2 = V, - = M)
OFF	ON	ON	ON	Balance video (V1 & V2)





VR5178 PROGRAMMING

When in programming mode, after 3 seconds of idle time, the unit will return to normal operation storing the parameter related to the function that was in progress.



VR5178 – Setting the number of rings

- When the system is in stand-by, press and hold  until the related LED starts flashing and the intercoms emit a beep.
- Press  as many times (each press is confirmed by a beep) as the number of rings (max 9) required.
- Once the number of rings required is reached (i.e. press 5 times for 5 rings), wait (approx 3 seconds) until the LED switches off.
- The new number of rings is stored.

VR5178 – Setting the melody and melody volume



- When the system is in stand-by, press and hold (for approx 10 seconds) the  button until the intercom plays the current melody and the “talk” and “privacy” LED’s illuminate. At the end of the current melody the intercom emits a beep and the “talk” and “privacy” LED’s start to flash.
- To adjust the volume of the melody, press (several times or hold) the  button to decrease the volume or the  button to increase the volume (the volume of emitted beeps vary according to the button pressed).
- Each time the  button is pressed, a new melody (9 are available) is selected: the “talk” and “privacy” LED’s stop flashing during play, at the end a beep is emitted and the two LED’s restart to flash. Repeat the step above to select a new melody otherwise wait approx 3 seconds (the LEDs switch OFF) without pressing any button to accept the melody played and set the volume as adjusted.

VR5178 - Privacy duration programming

- Press and hold  (for approx 10 seconds) until the unit emits a beep and the related LED starts flashing.
- Each time  is pressed, it will increase the privacy duration by 30 minutes (starting from 0 up to a maximum of 20 hours i.e. pressing the button 6 times = 3 hours up to a maximum of 40 presses for 20 hours). To set the privacy with no time out do not press the button.
- Once the required privacy duration has been reached, wait 3 seconds for the exit beep.
- The new value is now stored.

VR5178 – Speech volume adjustments

- When a conversation is in progress (“speak” LED illuminated), press : the “privacy” LED starts flashing and the “talk” LED turns OFF.













- Press (several times or hold pressed) “” to increase the speech volume or the “” button to decrease the volume.
- Once the required volume level is reached, wait approx 3 seconds or press again the “” button.
- The “privacy” LED switches OFF while the “talk” LED switches back ON.

VR5478 PROGRAMMING MENU'S













The video monitor has two menus for programming and adjustment functions:

1. The 1st menu can be entered when the system is in stand-by and allows the following settings:
 - Privacy duration, melody volume, melody, number of rings. (Note: 20Vdc must be on for this function)
2. The 2nd menu is available when the system is turned ON (during a conversation or a camera recall)
 - Speech volume, brightness, contrast, hue

Menu 1

- When the system is in stand-by (monitor turned OFF) press and hold (for approx 9 seconds) “” to enter the programming menu;
- The menu appears on the display: the top of the screen shows “menu” followed by the available function icons, the bottom of the screen shows the currently selected function value on the left, the currently selected function icon in the middle and the next function icon on the right.
- The first function is the privacy duration time (max 20 hours): press (several times or hold) “” to increase or “” to decrease the duration in multiples of 30 minutes for each press (signalled by a beep).
- Press “” to store the new value and to move onto the next programming option.
- Next is the melody volume: press (several times or hold) “” to increase or “” to decrease the melody volume (signalled by a beep).
- Press “” to store the new value and to move onto the next programming option.
- Next is the melody type: press “” to hear and select the previous melody or “” to hear and select the following melody (9 available).
- Press “” to store the new value and to move onto the next programming option.
- Next and final is the number of rings (max 9): (press several times or hold) “” to increase or “” to decrease the number of rings.
- Press “” to store the new value and exit the programming menu, the monitor turns OFF.

Menu 2

- When the system is turned ON (conversation or camera recall) press “” to enter the programming menu.
- The menu appears on the display: the top of the screen shows “menu” followed by the allowed function icons, the bottom of the screen shows the currently selected function value on the left, the currently selected function icon in the middle and the next function icon on the right.
- The first function is the speech volume: press (Several times or hold) “” to increase or “” to decrease the speech volume level (signalled by a beep).
- Press “” to store the new value and to move onto the next programming option.
- Next is the picture brightness: press (Several times or hold) “” to increase or “” to decrease the brightness level (signalled by a beep).
- Press “” to store the new value and to move onto the next programming option.
- Next is the picture contrast: press (Several times or hold) “” to increase or “” to decrease the contrast level (signalled by a beep).
- Press “” to store the new value and to move onto the next programming option.
- The next and last function is the picture hue: press (Several times or hold) “” to increase or “” to decrease the hue level (signalled by a beep).
- Press “” to store the new value and exit the programming menu the monitor goes back to shown standard messages for call progress.

Technical Specifications

	Audio	Video
Addressing range	: from 1 to 180 (BIN code)	: from 1 to 180 (BIN code)
Working voltage	: 12Vdc	
Stand-by absorption	: about 6mA	: approx 12mA standby on 12V input
Phone max. absorption	: about 50mA	: approx 70mA max on 12Vdc input : approx 250mA max on 20Vdc input
Working temperature	: -10 +50 C°	: -10 +50 C°

Video monitor (3678)

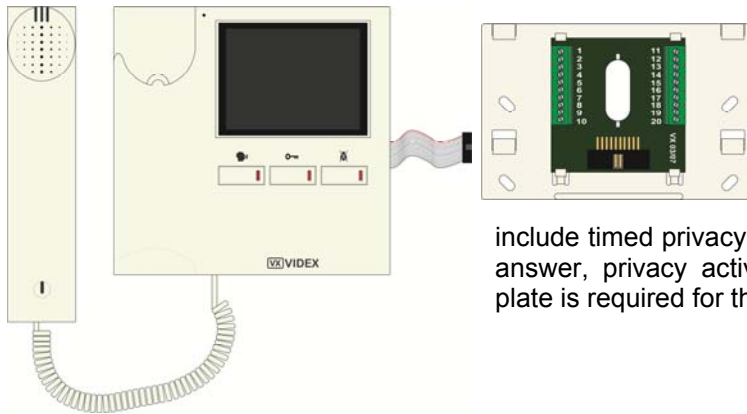

The 3678 is a wall mount colour videophone with 3.5" TFT OSD monitor. Both handset and handsfree (Half duplex) speech are available along with the facility to switch into simplex speech mode by holding the talk/answer button down for more than 3 seconds. Additional features include timed privacy, an auxiliary output and LED's to indicate call answer, privacy active and door release. An Art.5980 mounting plate is required for this monitor.

PUSH BUTTONS	
	Answer button - On an incoming call, operation of this button allows the user to answer and converse with the visitor without lifting the handset. The LED next to the button will illuminate.
📞	Switch off button - With the system switched on (Call in progress), momentary operation of the button will end the call (Alternatively, replacing the handset will also end the call). The apartment station will also automatically switch off after a time delay if the button is not pressed. The LED next to the button will switch off.
	Simplex button - Pressing and holding the button for more than 3 seconds will switch the apartment station into SIMPLEX speech mode. Press and hold the button to speak to the caller (The LED next to the button will flash rapidly), release the button to listen (The LED will flash slowly). If the button is not pressed for 10 seconds the apartment station will switch off. The apartment station will revert to duplex speech when another call is made.
🔒	Privacy on-off button - Enable/disable the service. The LED next to the button will illuminate when the privacy service is enabled. Pressing this button while the unit is ringing will reject a call.
	During a call, this button acts as a menu button to enter programming mode if pressed momentarily or if pressing until a beep is omitted, activates the auxiliary output (SB)
🔑	Concierge call button - While in standby, press this button to call the concierge (If service is available).
	Door open button - During a call, operation of this button will activate the door.

Terminal	Signal	Description
1 & 2	+20V	Video power supply input 17-20Vdc
3 & 4	GND	Video power ground connection
5	V2/V	Balanced video V2 input or coax centre core (Set by 4 way dip-switches)
6	V1	Balanced video V1 input
7	L	Data/speech bus input
8	GND	Bus ground
9	LB	Local door bell input (Switched to ground to trigger)
10	AL	Alarm button input (Switch to ground to trigger)
11		Not Used
12	SB	S1 push button (Shorts to Ground when pressed)
13 & 14		Not Used
15	+VD	+12Vdc output to power video distribution unit (Art. 894)
16	GND	Ground
17	12VO	Regulated 12Vdc output
18	12VI	+12Vdc power supply input
19	LD	Auxiliary LED +12V input (LED next to door open button)
20	GND	Ground

PROGRAMMING

Address programming is carried out by setting the internal 8 way dip-switch to the positions shown on the decimal/binary conversion table of this manual.

The four way dip-switch sets the video signal type accepted by the monitor as shown in the table below:-

4 WAY DIPSWITCH				Video Mode
1	2	3	4	
ON	OFF	ON	ON	Coaxial video (V2 = V, - = M)
OFF	ON	ON	ON	Balance video (V1 & V2)

Note: Switches 3 & 4 are video end of line termination (Both on for end of line termination or both off for no end of line termination)

3678 PROGRAMMING MENU

The video monitor has two menus for programming and adjustment functions:

1. The 1st menu can be entered when the system is in stand-by and allows the following settings:
 - Privacy duration, melody volume, melody, number of rings. (Note: 20Vdc must be on for this function)
2. The 2nd menu is available when the system is turned ON (during a conversation or a camera recall)
 - Speech volume, brightness, contrast, hue

Menu 1

- When the system is in stand-by (monitor turned OFF) press and hold (for approx 9 seconds) "M" to enter the programming menu;
- The menu appears on the display: the top of the screen shows "menu" followed by the available function icons, the bottom of the screen shows the currently selected function value on the left, the currently selected function icon in the middle and the next function icon on the right.
- The first function is the privacy duration time (max 20 hours): press (several times or hold) "0-9" to increase or "←" to decrease the duration in multiples of 30 minutes for each press (signalled by a beep).
- Press "M" to store the new value and to move onto the next programming option.
- Next is the melody volume: press (several times or hold) "0-9" to increase or "←" to decrease the melody volume (signalled by a beep).
- Press "M" to store the new value and to move onto the next programming option.
- Next is the melody type: press "0-9" to hear and select the previous melody or "←" to hear and select the following melody (9 available).
- Press "M" to store the new value and to move onto the next programming option.
- Next and final is the number of rings (max 9): (press several times or hold) "0-9" to increase or "←" to decrease the number of rings.
- Press "M" to store the new value and exit the programming menu, the monitor turns OFF.

Menu 2

- When the system is turned ON (conversation or camera recall) press "M" to enter the programming menu.
- The menu appears on the display: the top of the screen shows "menu" followed by the allowed function icons, the bottom of the screen shows the currently selected function value on the left, the currently selected function icon in the middle and the next function icon on the right.
- The first function is the speech volume: press (Several times or hold) "0-9" to increase or "←" to decrease the speech volume level (signalled by a beep).
- Press "M" to store the new value and to move onto the next programming option.
- Next is the picture brightness: press (Several times or hold) "0-9" to increase or "←" to decrease the brightness level (signalled by a beep).
- Press "M" to store the new value and to move onto the next programming option.
- Next is the picture contrast: press (Several times or hold) "0-9" to increase or "←" to decrease the contrast level (signalled by a beep).
- Press "M" to store the new value and to move onto the next programming option.
- The next and last function is the picture hue: press (Several times or hold) "0-9" to increase or "←" to decrease the hue level (signalled by a beep).
- Press "M" to store the new value and exit the programming menu the monitor goes back to shown standard messages for call progress.

Technical Specifications

Addressing range	: from 1 to 180 (BIN code)
Working voltage	: 20V input (17 – 20Vdc) : 12C input (12 – 14Vdc)
Stand-by absorption	: approx 12mA standby on 12V input
Phone max. absorption	: approx 70mA max on 12Vdc input : approx 250mA max on 20Vdc input
Working temperature	: -10 +50 C°

EXTENSION SOUNDER (512D) EXTENSION RELAY (512DR)

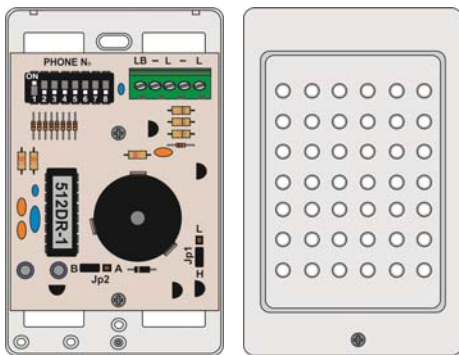

512D

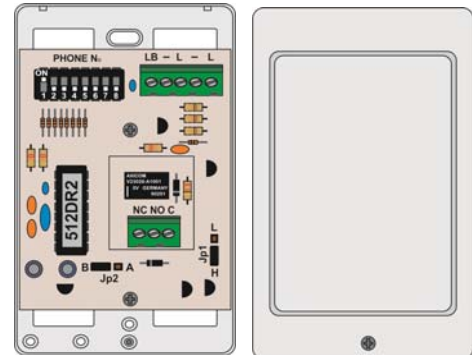

512DR

Compatible with the “2 wire” **BUS** and has an 8 way Dip-switch to program the address of the device. Up to 3 units can be addressed with the same number (Ex.: 1 intercom and 2 extension sounders to be operated with the same apartment number). The call tone is different according to the origin of the call (Main entrance call or local door bell). A two level volume control is available using jumper **JP1** (only for 512D, while for 512DR the JP1 is not used and stays in position “H”). Through the jumper **JP2** it is possible to set the number of rings (512D) or the number of relay pulses (512DR) between 1 or 6. The current consumption on the BUS line is less than 1mA in stand-by mode. The Art.512DR can also be used as a “service relay” for the entire BUS, activated by the alarm signal from an apartment. To use this function it is necessary to give the unit the address 255.

- The 512D unit will ring according to the programming (1 or 6 times), or until the intercom handset is picked up.
- The 512DR unit will operate the relay for 1 or 6 x 2 seconds on, 2 seconds off ,according to the programming, or until the intercom handset is picked up.

Local call:

- The 512D unit will ring the number of times the local bell is pressed.
- The 512DR unit will activate the relay each time the local bell is pressed and will remain active as long as the local bell remains pressed.

Alarm (only for 512DR addressed as 255)

The unit 512DR will activate the relay for 1 second (Independent of JP2 jumper settings).

Programming

The address of the unit must be programmed by means of the internal 8 way Dip-switch (see conversion table decimal/binary) and must be the same as the phone or videophone connected in the apartment. To use as a service relay activated by the alarm signals sent on the bus, set the address to 255.

In order to synchronize the local apartment call with the telephone, connect the “LB” terminal with the “LB” phone terminal.

Technical specifications

Addressing range	:	from 1 to 180
Stand-by absorption	:	less than about 0.9mA
Call absorption	:	Approx. 15mA
Relay contacts	:	(Art.512DR)1A 125Vac max
Working temperature	:	-10 +50 C°

INSTALLATION DIRECTIONS

Installation and maintenance must be carried out by specialized engineers only. Do not install the components of the system in humid environments or near heat sources. Make sure that the power supplies present in the system are not connected to the mains during the installation of devices. Before powering the system, check that the cabling is correct. The wiring diagrams must always be followed (in case of different applications contact Videx technical) and always use cables as outlined below. It is advisable to separate the Mains lines (lift, electricity, electricity lock, etc.) from the BUS lines (A distance of at least 10 cm) to avoid electrostatic discharge and magnetic influence that could cause problems to the on the system. It is also very important to set all dip switches before powering up. If any are changed for any reason it is necessary to power that device down and then back up for the change to take effect.

GUIDELINES TO OVERCOME EXTREME ELECTROMAGNETIC INTERFERENCE

In situations of EMI where interference is affecting the functions of the system it is advised to add the following:

- Loop the mains cable twice through the ferrite core (Model No. RT310-190-160 or equivalent).
- Loop the bus cable which connects the video distributor to the videophone twice through the ferrite core (Model No. RKCF-13-A5 or equivalent)

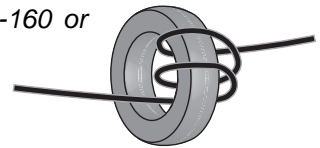

For the mains cable:-

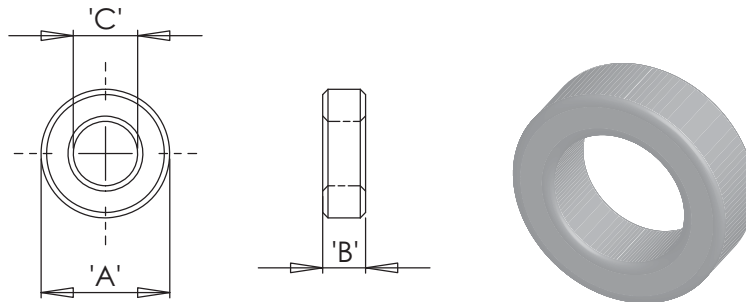

FERRITE MATERIAL: K5B						
PART NUMBER	A	B	C	IMPEDANCE (Ω)		STANDARD PACK
				25MHz	100MHz	
RT-310-190-160-K5B	31.00	16.00	19.00	68	115	40

For the videophone:-

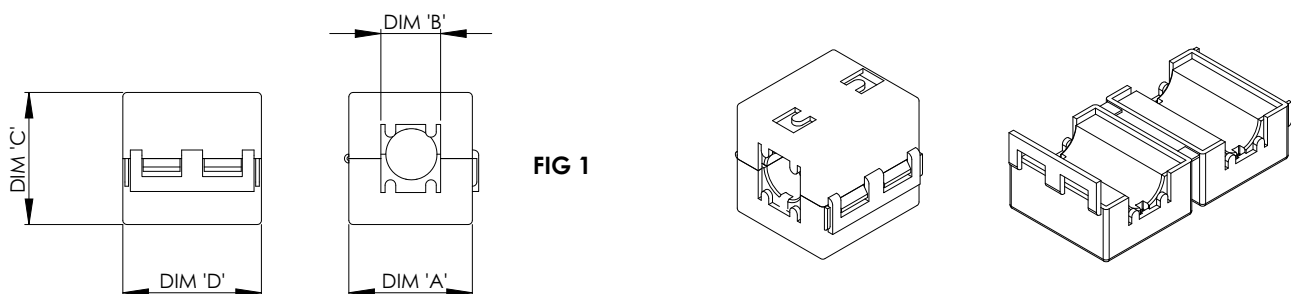

FIG 1

Ferrite Material: A									
Part No	'A' Dim	'B' Dim	'C' Dim	'D' Dim	Impedan		Applicable Cable Max Dia	Standard Pack Pieces	Fig
					25 MHz	100 MHz			
RKCF-13-A5	31.50 \pm 1.00	14.00 \pm 1.00	31.50 \pm 1.00	32.50 \pm 1.00	150	250	13	32	1

CABLE GUIDE

The following table outlines the maximum resistance allowed from furthest point to furthest point.

Cable sizes				
Distance up to	(-) (L) (V1)* (V2)* Signals	Max. Resistance	(-)* (+20)* Signals	Max. Resistance
100m	0.3mmsq AWG22	7.5 Ohms	0.6mmsq AWG19	5 Ohms
200m	0.6mmsq AWG19		1.0mmsq AWG17	
350m	1.0mmsq AWG17		1.5mmsq AWG15	
500m	1.5mmsq AWG15			

Supply cables (power supply → outdoor station): they must have a minimum size of 1.0mmsq (AWG17) or more (Depending on the distance between the supply's and the outdoor station) with maximum resistance of **1.5 Ohm** per core.

Door panel earth: All vandal resistant door panels must be earthed (Earth studs will be found on all vandal resistant panels and back boxes). To accomodate this we suggest running a 2.5mm² earth cable from the panel to the control cabinet where it can be connected to the cabinets earth.

Art.3161 Art.3162 Art.3171 Art.3172						
MIN. CORES	<50m	<100m	<200m	<300m	<400m	<500m
2	4 Pair CW1308 CAT5	4 Pair CW1308 4 Core 0.5mm ² YY CAT5	6 Pair CW1308 4 Core 0.75mm ² YY	6 Pair CW1308 4 Core 1.0mm ² YY	4 Core 1.5mm ² YY	4 Core 2.5mm ² YY
Art.3176						
3	4 Pair CW1308 CAT5	6 Pair CW1308 12 Core 0.5mm ² YY	6 Pair CW1308 12 Core 0.5mm ² YY	10 Pair CW1308 12 Core 0.5mm ² YY	7 Core 1.5mm ² YY	7 Core 2.5mm ² YY
Art.5178 Art.VR5178						
4	4 Pair CW1308 CAT5	4 Pair CW1308 12 Core 0.5mm ² YY	6 Pair CW1308 12 Core 0.5mm ² YY	10 Pair CW1308 12 Core 0.5mm ² YY	12 Core 1.0mm ² YY	Not recommended
Art.3371 Art.3471						
MIN. CORES	<50m	<100m	<200m	<300m	<400m	<500m
Balanced = 6	4 Pair CW1308 CAT5	6 Pair CW1308 or 12 Core 0.5mm ² YY	10 Pair CW1308 or 12 Core 0.5mm ² YY	12 Core 0.5mm ² YY	Not recommended	Not recommended
Coax = 4 + Coax	4 Pair CW1308 or CAT5 + RG59 (BC)	6 Pair CW1308 or 12 Core 0.5mm ² YY + RG59 (BC)	6 Pair CW1308 or 12 Core 0.5mm ² YY + RG59 (BC)	12 Core 0.5mm ² YY + RG11 (BC)	12 Core 0.75mm ² YY + RG11 (BC)	12 Core 1.0mm ² YY + RG11 (BC)
Art.3376 Art.3476						
Balanced = 7	4 Pair CW1308	6 Pair CW1308 or 12 Core 0.5mm ² YY	10 Pair CW1308 or 12 Core 0.5mm ² YY	12 Core 0.5mm ² YY	Not recommended	Not recommended
Coax = 5 + Coax	4 Pair CW1308 + RG59 (BC)	6 Pair CW1308 or 12 Core 0.5mm ² YY + RG59 (BC)	6 Pair CW1308 or 12 Core 0.5mm ² YY + RG59 (BC)	12 Core 0.5mm ² YY + RG11 (BC)	12 Core 0.75mm ² YY + RG11 (BC)	12 Core 1.0mm ² YY + RG11 (BC)
Art.5476 Art.5478 Art.SL5478 Art.VR5478 Art.3678						
Balanced = 8	6 Pair CW1308	10 Pair CW1308 or 12 Core 0.5mm ² YY	12 Core 0.5mm ² YY	Not recommended	Not recommended	Not recommended
Coax = 7 + Coax	6 Pair CW1308 + RG59 (BC)	10 Pair CW1308 or 12 Core 0.5mm ² YY + RG59 (BC)	12 Core 0.5mm ² YY + RG59 (BC)	12 Core 0.75mm ² YY + RG11 (BC)	12 Core 1.0mm ² YY + RG11 (BC)	12 Core 1.5mm ² YY + RG11 (BC)

CAT5 NOTES: Only recommended for systems with up to 20 apartments and maximum distances of 70m for mono video or 100m for colour video. Calculations based on a DC loop resistance <math><0.188\text{ Ohm/m}</math> (Converts to 94 Ohm/km). The following cores should be used on video systems. It is recommended to double up as a minimum (More cores may be required) the cores on audio systems as well:-

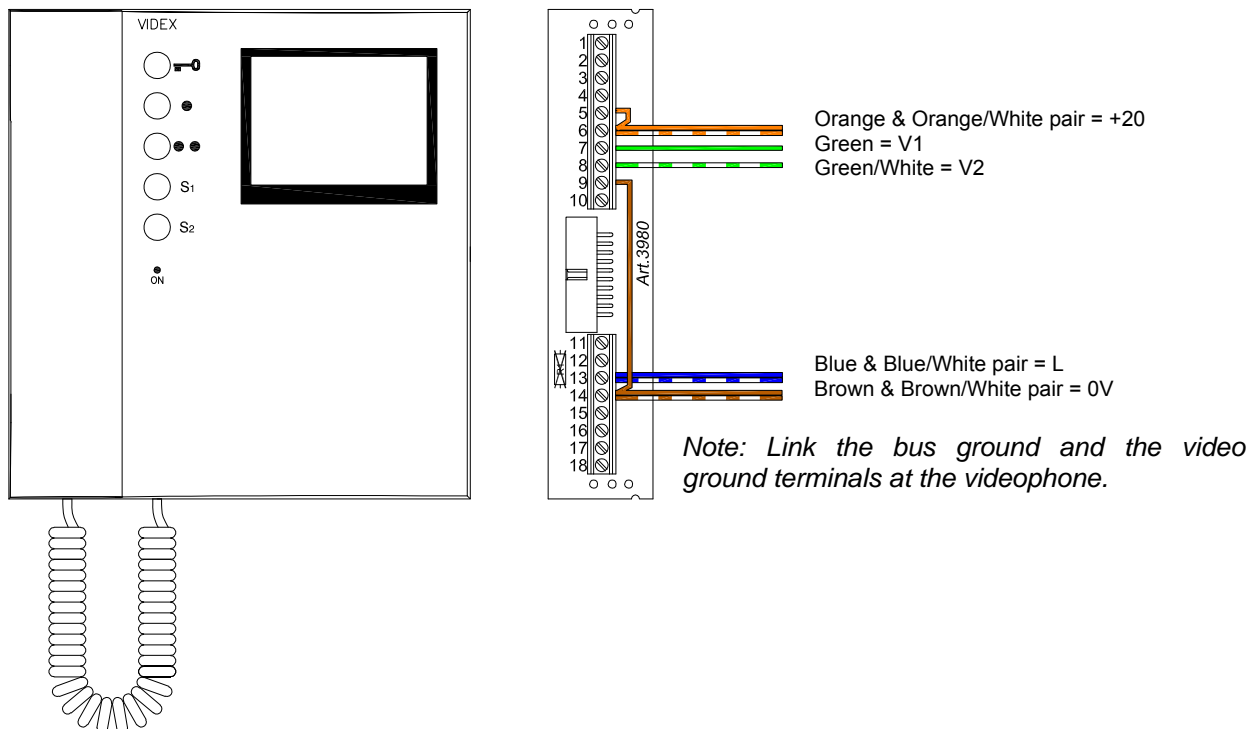

CW1308 NOTES: CW1308 should have a maximum resistance of 97.8Ω/km. Calculate how many cores are required for each connection ensuring the maximum overall resistance on the L, - does not exceed 7.5 Ω, V1 & V2 does not exceed 15Ω and the power connections (+12, +20 & Video ground) does not exceed 5Ω. All other connections can have a maximum resistance of 10Ω

COAX NOTES: All videophones and video monitors can be supplied with coax video or balanced video (Dip switches must be set correctly). The following cables are recommended:

- RG59(BC)** for internal use and distances of up to 200m (BC stands for bare copper. Copper coated steel CCS versions should not be used)
- RG11** for internal use and distances up to 600m.
- CT100** for external protected use and distances up to 200m.
- CT125** for external protected use and distances up to 600m.

YY NOTES: It is not recommended to use YY cable larger than 0.5mm² for the balanced video connections V1 & V2 or to try doubling up on these connections as this will increase the capacitance of the cable and could deteriorate the picture quality.

All the above cables are for internal wiring only unless otherwise stated.

SYSTEM NOTES

- Before switch on the system, check the cabling and set all dip-switches
- Remember to terminate the video end of line.
- All phones, videophones and accessories are identified by an address programmed through the 8 way Dip-switch and each device must have a different address; see decimal/binary conversion table to program the addresses. **Note that each peripheral (phone, videophone or accessory) reads its address from the dip-switch at power up (when the system is powered): to change the address of a peripheral, it is necessary that the peripheral is disconnected from the system (disconnect the BUS wires for the device, and then reconnect.**
- In case someone needs to activate more than one device by a single call (for example 2 intercoms in the same apartment or 1 intercom and 1 additional sounder or 2 videophones, etc.), all devices must have the same address (up to 3 devices max.). If the 3 units are videophones, to switch on at the same time another power supply must be added, because the power supply Art.893N1 can supply a maximum 2 videophones at the same time.
- It is necessary to check that master and slave programming of call panels are correct.

SPEECH ADJUSTMENT

It is necessary to adjust the speech volume to have the best performance without “Larsen” effect (Feedback). It is advisable to carry out the following procedure:

1. Be sure that microphone volume and speaker volume trimmers are in the middle position (access holes to the trimmers at the back of the panels);
2. Make a call from the panel to the nearest phone on the BUS (the handset must be picked up) and speak near the microphone of the outdoor station adjusting the balance trimmer in order to have the lowest feedback from the speaker of the outdoor station;
3. Make another call towards the farthest phone in the BUS line (the handset must be picked up), then check the speech again at the nearest phone;







































To adjust the handset microphone level, turn left or right the VR1 trimmer (inside the unit).







































DIP-SWITCH SETTINGS



























The following tables can be used when setting dip-switches on telephones, videophones and video monitors. **Please note: All dip-switches must be set before power up.**



























Dip-sw 2 =off Dip-sw 3 =off		DIP-SWITCH setting								
Dec. Nr.	Art.2203 Input Matrix		1	2	3	4	5	6	7	8
1	1a		ON	OFF	OFF	OFF	OFF	OFF	OFF	OFF
2	1b		OFF	ON	OFF	OFF	OFF	OFF	OFF	OFF
3	1c		ON	ON	OFF	OFF	OFF	OFF	OFF	OFF
4	1d		OFF	OFF	ON	OFF	OFF	OFF	OFF	OFF
5	1e		ON	OFF	ON	OFF	OFF	OFF	OFF	OFF
6	1f		OFF	ON	ON	OFF	OFF	OFF	OFF	OFF
7	1g		ON	ON	ON	OFF	OFF	OFF	OFF	OFF
8	1h		OFF	OFF	OFF	ON	OFF	OFF	OFF	OFF
9	2a		ON	OFF	OFF	ON	OFF	OFF	OFF	OFF
10	2b		OFF	ON	OFF	ON	OFF	OFF	OFF	OFF
11	2c		ON	ON	OFF	ON	OFF	OFF	OFF	OFF
12	2d		OFF	OFF	ON	ON	OFF	OFF	OFF	OFF
13	2e		ON	OFF	ON	ON	OFF	OFF	OFF	OFF
14	2f		OFF	ON	ON	ON	OFF	OFF	OFF	OFF
15	2g		ON	ON	ON	ON	OFF	OFF	OFF	OFF
16	2h		OFF	OFF	OFF	OFF	ON	OFF	OFF	OFF
17	3a		ON	OFF	OFF	OFF	ON	OFF	OFF	OFF
18	3b		OFF	ON	OFF	OFF	ON	OFF	OFF	OFF
19	3c		ON	ON	OFF	OFF	ON	OFF	OFF	OFF
20	3d		OFF	OFF	ON	OFF	ON	OFF	OFF	OFF
21	3e		ON	OFF	ON	OFF	ON	OFF	OFF	OFF
22	3f		OFF	ON	ON	OFF	ON	OFF	OFF	OFF
23	3g		ON	ON	ON	OFF	ON	OFF	OFF	OFF
24	3h		OFF	OFF	OFF	ON	ON	OFF	OFF	OFF
25	4a		ON	OFF	OFF	ON	ON	OFF	OFF	OFF
26	4b		OFF	ON	OFF	ON	ON	OFF	OFF	OFF
27	4c		ON	ON	OFF	ON	ON	OFF	OFF	OFF

Dip-sw 2 =on Dip-sw 3 =off		DIP-SWITCH setting								
Dec. Nr.	Art.2203 Input Matrix		1	2	3	4	5	6	7	8
65	1a		ON	OFF	OFF	OFF	OFF	OFF	ON	OFF
66	1b		OFF	ON	OFF	OFF	OFF	OFF	ON	OFF
67	1c		ON	ON	OFF	OFF	OFF	OFF	ON	OFF
68	1d		OFF	OFF	ON	OFF	OFF	OFF	ON	OFF
69	1e		ON	OFF	ON	OFF	OFF	OFF	ON	OFF
70	1f		OFF	ON	ON	OFF	OFF	OFF	ON	OFF
71	1g		ON	ON	ON	OFF	OFF	OFF	ON	OFF
72	1h		OFF	OFF	OFF	ON	OFF	OFF	ON	OFF
73	2a		ON	OFF	OFF	ON	OFF	OFF	ON	OFF
74	2b		OFF	ON	OFF	ON	OFF	OFF	ON	OFF
75	2c		ON	ON	OFF	ON	OFF	OFF	ON	OFF
76	2d		OFF	OFF	ON	ON	OFF	OFF	ON	OFF
77	2e		ON	OFF	ON	ON	OFF	OFF	ON	OFF
78	2f		OFF	ON	ON	ON	OFF	OFF	ON	OFF
79	2g		ON	ON	ON	ON	OFF	OFF	ON	OFF
80	2h		OFF	OFF	OFF	OFF	ON	OFF	ON	OFF
81	3a		ON	OFF	OFF	OFF	ON	OFF	ON	OFF
82	3b		OFF	ON	OFF	OFF	ON	OFF	ON	OFF
83	3c		ON	ON	OFF	OFF	ON	OFF	ON	OFF
84	3d		OFF	OFF	ON	OFF	ON	OFF	ON	OFF
85	3e		ON	OFF	ON	OFF	ON	OFF	ON	OFF
86	3f		OFF	ON	ON	OFF	ON	OFF	ON	OFF
87	3g		ON	ON	ON	OFF	ON	OFF	ON	OFF
88	3h		OFF	OFF	OFF	ON	ON	OFF	ON	OFF
89	4a		ON	OFF	OFF	ON	ON	OFF	ON	OFF
90	4b		OFF	ON	OFF	ON	ON	OFF	ON	OFF
91	4c		ON	ON	OFF	ON	ON	OFF	ON	OFF

Dip-sw 2 =off Dip-sw 3 =off		DIP-SWITCH setting								
Dec. Nr.	Art.2203 Input Matrix		1	2	3	4	5	6	7	8
28	4d		OFF	OFF	ON	ON	ON	OFF	OFF	OFF
29	4e		ON	OFF	ON	ON	ON	OFF	OFF	OFF
30	4f		OFF	ON	ON	ON	ON	OFF	OFF	OFF
31	4g		ON	ON	ON	ON	ON	OFF	OFF	OFF
32	4h		OFF	OFF	OFF	OFF	OFF	ON	OFF	OFF
33	5a		ON	OFF	OFF	OFF	OFF	ON	OFF	OFF
34	5b		OFF	ON	OFF	OFF	OFF	ON	OFF	OFF
35	5c		ON	ON	OFF	OFF	OFF	ON	OFF	OFF
36	5d		OFF	OFF	ON	OFF	OFF	ON	OFF	OFF
37	5e		ON	OFF	ON	OFF	OFF	ON	OFF	OFF
38	5f		OFF	ON	ON	OFF	OFF	ON	OFF	OFF
39	5g		ON	ON	ON	OFF	OFF	ON	OFF	OFF
40	5h		OFF	OFF	OFF	ON	OFF	ON	OFF	OFF
41	6a		ON	OFF	OFF	ON	OFF	ON	OFF	OFF
42	6b		OFF	ON	OFF	ON	OFF	ON	OFF	OFF
43	6c		ON	ON	OFF	ON	OFF	ON	OFF	OFF
44	6d		OFF	OFF	ON	ON	OFF	ON	OFF	OFF
45	6e		ON	OFF	ON	ON	OFF	ON	OFF	OFF
46	6f		OFF	ON	ON	ON	OFF	ON	OFF	OFF
47	6g		ON	ON	ON	ON	OFF	ON	OFF	OFF
48	6h		OFF	OFF	OFF	OFF	ON	ON	OFF	OFF
49	7a		ON	OFF	OFF	OFF	ON	ON	OFF	OFF
50	7b		OFF	ON	OFF	OFF	ON	ON	OFF	OFF
51	7c		ON	ON	OFF	OFF	ON	ON	OFF	OFF
52	7d		OFF	OFF	ON	OFF	ON	ON	OFF	OFF
53	7e		ON	OFF	ON	OFF	ON	ON	OFF	OFF
54	7f		OFF	ON	ON	OFF	ON	ON	OFF	OFF
55	7g		ON	ON	ON	OFF	ON	ON	OFF	OFF
56	7h		OFF	OFF	OFF	ON	ON	ON	OFF	OFF
57	8a		ON	OFF	OFF	ON	ON	ON	OFF	OFF
58	8b		OFF	ON	OFF	ON	ON	ON	OFF	OFF
59	8c		ON	ON	OFF	ON	ON	ON	OFF	OFF
60	8d		OFF	OFF	ON	ON	ON	ON	OFF	OFF
61	8e		ON	OFF	ON	ON	ON	ON	OFF	OFF
62	8f		OFF	ON	ON	ON	ON	ON	OFF	OFF
63	8g		ON	ON	ON	ON	ON	ON	OFF	OFF
64	8h		OFF	OFF	OFF	OFF	OFF	OFF	ON	OFF

Dip-sw 2 =on Dip-sw 3 =off		DIP-SWITCH setting								
Dec. Nr.	Art.2203 Input Matrix		1	2	3	4	5	6	7	8
92	4d		OFF	OFF	ON	ON	ON	OFF	ON	OFF
93	4e		ON	OFF	ON	ON	ON	OFF	ON	OFF
94	4f		OFF	ON	ON	ON	ON	OFF	ON	OFF
95	4g		ON	ON	ON	ON	ON	OFF	ON	OFF
96	4h		OFF	OFF	OFF	OFF	OFF	ON	ON	OFF
97	5a		ON	OFF	OFF	OFF	OFF	ON	ON	OFF
98	5b		OFF	ON	OFF	OFF	OFF	ON	ON	OFF
99	5c		ON	ON	OFF	OFF	OFF	ON	ON	OFF
100	5d		OFF	OFF	ON	OFF	OFF	ON	ON	OFF
101	5e		ON	OFF	ON	OFF	OFF	ON	ON	OFF
102	5f		OFF	ON	ON	OFF	OFF	ON	ON	OFF
103	5g		ON	ON	ON	OFF	OFF	ON	ON	OFF
104	5h		OFF	OFF	OFF	ON	OFF	ON	ON	OFF
105	6a		ON	OFF	OFF	ON	OFF	ON	ON	OFF
106	6b		OFF	ON	OFF	ON	OFF	ON	ON	OFF
107	6c		ON	ON	OFF	ON	OFF	ON	ON	OFF
108	6d		OFF	OFF	ON	ON	OFF	ON	ON	OFF
109	6e		ON	OFF	ON	ON	OFF	ON	ON	OFF
110	6f		OFF	ON	ON	ON	OFF	ON	ON	OFF
111	6g		ON	ON	ON	ON	OFF	ON	ON	OFF
112	6h		OFF	OFF	OFF	OFF	ON	ON	ON	OFF
113	7a		ON	OFF	OFF	OFF	ON	ON	ON	OFF
114	7b		OFF	ON	OFF	OFF	ON	ON	ON	OFF
115	7c		ON	ON	OFF	OFF	ON	ON	ON	OFF
116	7d		OFF	OFF	ON	OFF	ON	ON	ON	OFF
117	7e		ON	OFF	ON	OFF	ON	ON	ON	OFF
118	7f		OFF	ON	ON	OFF	ON	ON	ON	OFF
119	7g		ON	ON	ON	OFF	ON	ON	ON	OFF
120	7h		OFF	OFF	OFF	ON	ON	ON	ON	OFF
121	8a		ON	OFF	OFF	ON	ON	ON	ON	OFF
122	8b		OFF	ON	OFF	ON	ON	ON	ON	OFF
123	8c		ON	ON	OFF	ON	ON	ON	ON	OFF
124	8d		OFF	OFF	ON	ON	ON	ON	ON	OFF
125	8e		ON	OFF	ON	ON	ON	ON	ON	OFF
126	8f		OFF	ON	ON	ON	ON	ON	ON	OFF
127	8g		ON	ON	ON	ON	ON	ON	ON	OFF
128	1a		OFF	OFF	OFF	OFF	OFF	OFF	OFF	ON

Dip-sw 2 =off Dip-sw 3 =on		DIP-SWITCH setting								
Dec. Nr.	Art.2203-1 Input Matrix		1	2	3	4	5	6	7	8
129	1b		ON	OFF	OFF	OFF	OFF	OFF	OFF	ON
130	1c		OFF	ON	OFF	OFF	OFF	OFF	OFF	ON
131	1d		ON	ON	OFF	OFF	OFF	OFF	OFF	ON
132	1e		OFF	OFF	ON	OFF	OFF	OFF	OFF	ON
133	1f		ON	OFF	ON	OFF	OFF	OFF	OFF	ON
134	1g		OFF	ON	ON	OFF	OFF	OFF	OFF	ON
135	1h		ON	ON	ON	OFF	OFF	OFF	OFF	ON
136	2a		OFF	OFF	OFF	ON	OFF	OFF	OFF	ON
137	2b		ON	OFF	OFF	ON	OFF	OFF	OFF	ON
138	2c		OFF	ON	OFF	ON	OFF	OFF	OFF	ON
139	2d		ON	ON	OFF	ON	OFF	OFF	OFF	ON
140	2e		OFF	OFF	ON	ON	OFF	OFF	OFF	ON
141	2f		ON	OFF	ON	ON	OFF	OFF	OFF	ON
142	2g		OFF	ON	ON	ON	OFF	OFF	OFF	ON
143	2h		ON	ON	ON	ON	OFF	OFF	OFF	ON
144	3a		OFF	OFF	OFF	OFF	ON	OFF	OFF	ON
145	3b		ON	OFF	OFF	OFF	ON	OFF	OFF	ON
146	3c		OFF	ON	OFF	OFF	ON	OFF	OFF	ON
147	3d		ON	ON	OFF	OFF	ON	OFF	OFF	ON
148	3e		OFF	OFF	ON	OFF	ON	OFF	OFF	ON
149	3f		ON	OFF	ON	OFF	ON	OFF	OFF	ON
150	3g		OFF	ON	ON	OFF	ON	OFF	OFF	ON
151	3h		ON	ON	ON	OFF	ON	OFF	OFF	ON
152	4a		OFF	OFF	OFF	ON	ON	OFF	OFF	ON
153	4b		ON	OFF	OFF	ON	ON	OFF	OFF	ON
154	4c		OFF	ON	OFF	ON	ON	OFF	OFF	ON

Dip-sw 2 =off Dip-sw 3 =on		DIP-SWITCH setting								
Dec. Nr.	Art.2203-1 Input Matrix		1	2	3	4	5	6	7	8
155	4d		ON	ON	OFF	ON	ON	OFF	OFF	ON
156	4e		OFF	OFF	ON	ON	ON	OFF	OFF	ON
157	4f		ON	OFF	ON	ON	ON	OFF	OFF	ON
158	4g		OFF	ON	ON	ON	ON	OFF	OFF	ON
159	4h		ON	ON	ON	ON	ON	OFF	OFF	ON
160	5a		OFF	OFF	OFF	OFF	OFF	ON	OFF	ON
161	5b		ON	OFF	OFF	OFF	OFF	ON	OFF	ON
162	5c		OFF	ON	OFF	OFF	OFF	ON	OFF	ON
163	5d		ON	ON	OFF	OFF	OFF	ON	OFF	ON
164	5e		OFF	OFF	ON	OFF	OFF	ON	OFF	ON
165	5f		ON	OFF	ON	OFF	OFF	ON	OFF	ON
166	5g		OFF	ON	ON	OFF	OFF	ON	OFF	ON
167	5h		ON	ON	ON	OFF	OFF	ON	OFF	ON
168	6a		OFF	OFF	OFF	ON	OFF	ON	OFF	ON
169	6b		ON	OFF	OFF	ON	OFF	ON	OFF	ON
170	6c		OFF	ON	OFF	ON	OFF	ON	OFF	ON
171	6d		ON	ON	OFF	ON	OFF	ON	OFF	ON
172	6e		OFF	OFF	ON	ON	OFF	ON	OFF	ON
173	6f		ON	OFF	ON	ON	OFF	ON	OFF	ON
174	6g		OFF	ON	ON	ON	OFF	ON	OFF	ON
175	6h		ON	ON	ON	ON	OFF	ON	OFF	ON
176	7a		OFF	OFF	OFF	OFF	ON	ON	OFF	ON
177	7b		ON	OFF	OFF	OFF	ON	ON	OFF	ON
178	7c		OFF	ON	OFF	OFF	ON	ON	OFF	ON
179	7d		ON	ON	OFF	OFF	ON	ON	OFF	ON
180	7e		OFF	OFF	ON	OFF	ON	ON	OFF	ON

TROUBLE SHOOTING GUIDE

PROBLEM FOUND	POSSIBLE CAUSE	POSSIBLE SOLUTION
The system has power but the front panel does not turn on.	<ol style="list-style-type: none"> 1. Interruption or short circuit of the 13Vdc output on PSU to the outdoor station; 2. PSU defective or fuse blown. 	<ol style="list-style-type: none"> 1. Check the GND and +13V connections on PSU and on panel, then check the protection fuse on the output of PSU and change it if necessary; 2. Check PSU output with and without load.
Front panel display shows "ERROR" and the unit makes acoustic intermittent signals at intervals of approx. 2 seconds.	<ol style="list-style-type: none"> 1. Probable short circuit on the BUS "-" and "L" line; 2. Reversion of polarity on the BUS connection of a phone, videophone or accessory; 3. Panel programmed as "Slave" when it should be as "Master". 	<ol style="list-style-type: none"> 1. Check the BUS connections. 2. Check the polarity of the devices connected. 3. Configure the device as "Master"
The system, at the moment of the call, is not able to let the extension ring, the front panel makes acoustic signals of line engaged and the display shows "Error".	<ol style="list-style-type: none"> 1. The phone or videophone called is not correctly connected; 2. The cable size (BUS) is too small; 3. The address programmed on the dip-switch (of the phone, videophone or accessory) does not correspond to that called; 4. The concierge (if present in the system) has been left in programming mode. 	<ol style="list-style-type: none"> 1. Check the connection of the BUS 2. Double or increase cable size; 3. Check that the address associated to the call corresponds to that programmed on the dip-switch of the phone (videophone or accessory); 4. Remove concierge from programming mode.
The outdoor station makes the call correctly, but when the user answers, the communication is cut off.	The cable size is too small.	Double or increase cable size
During the conversation, when the door is opened, the communication is cut off.	The cable size is too small.	Double or increase cable size
The calls goes through, but the conversation is one-way only.	The supplying voltage on the outdoor station is too low (under 10.5V).	Increase the supply cable size (GND & 13V). Check voltage output on PSU and adjust if necessary.
The audio level of conversation is too low.	The levels of the conversation volumes in both directions are not appropriately adjusted or balanced.	Adjust on the outdoor station trimmers for microphone and loudspeaker so as to have the best levels without oscillations (Larsen effect)
The audio level is at its limit or oscillates (Larsen effect).	The "Balance" trimmer (outdoor station) is not appropriately set and/or the conversation volumes are programmed to high.	Adjust on the outdoor station the "balance" trimmer until the problem is solved and/or lower the volumes of the microphone and loudspeaker.
The door release is not working.	<ol style="list-style-type: none"> 1. Lock defective; 2. Connection wrong or interrupted; 3. Cable size too small; 4. Lock PSU faulty. 	<ol style="list-style-type: none"> 1. Change the lock; 2. Check connection continuity; 3. Increase cable size; 4. Check power supply output;
The local floor call does not work.	<ol style="list-style-type: none"> 1. Call push button defective; 2. Connection wrong or interrupted. 	<ol style="list-style-type: none"> 1. Check defect; 2. Check connection.
The internal video stations do not turn on.	<ol style="list-style-type: none"> 1. Art.893N power supply defective or in protection; 2. Art.893N is not operated by the outdoor station during the call (SL terminal); 3. Connection wrong or interrupted. 	<ol style="list-style-type: none"> 1. Check 893 with and without a load; 2. "-C" terminal of art.893N not correctly connected to the "SL" terminal of the outdoor station; 3. Check the continuity of the connection between the monitor supplying wires and the videophones interested.
The internal video stations turn on, but the image does not appear.	<ol style="list-style-type: none"> 1. Art.830NC video camera not supplied or defective; 2. Connection of the V1-V2 signals interrupted or wrong. 3. Video dip-switches on monitor or jumpers on camera incorrectly positioned 	<ol style="list-style-type: none"> 1. Check and/or change art 830NC; 2. Check connection continuity. 3. Check all dip-switches and jumpers.
The internal video station turns on but the quality of the image is bad or reflected.	<ol style="list-style-type: none"> 1. Signal V1 or V2 not connected or in short circuit; 2. V1 & V2 signals inverted; 3. Closing resistances are missing at the end of the BUS video. 4. Dip-switches or jumpers on monitor or camera not correctly positioned 	<ol style="list-style-type: none"> 1. Check the continuity of the connection and the isolation to the ground; 2. Check and in case invert the connections; 3. Check and in case apply the closing resistances on the BUS video. 4. Check dip-switches and jumpers.

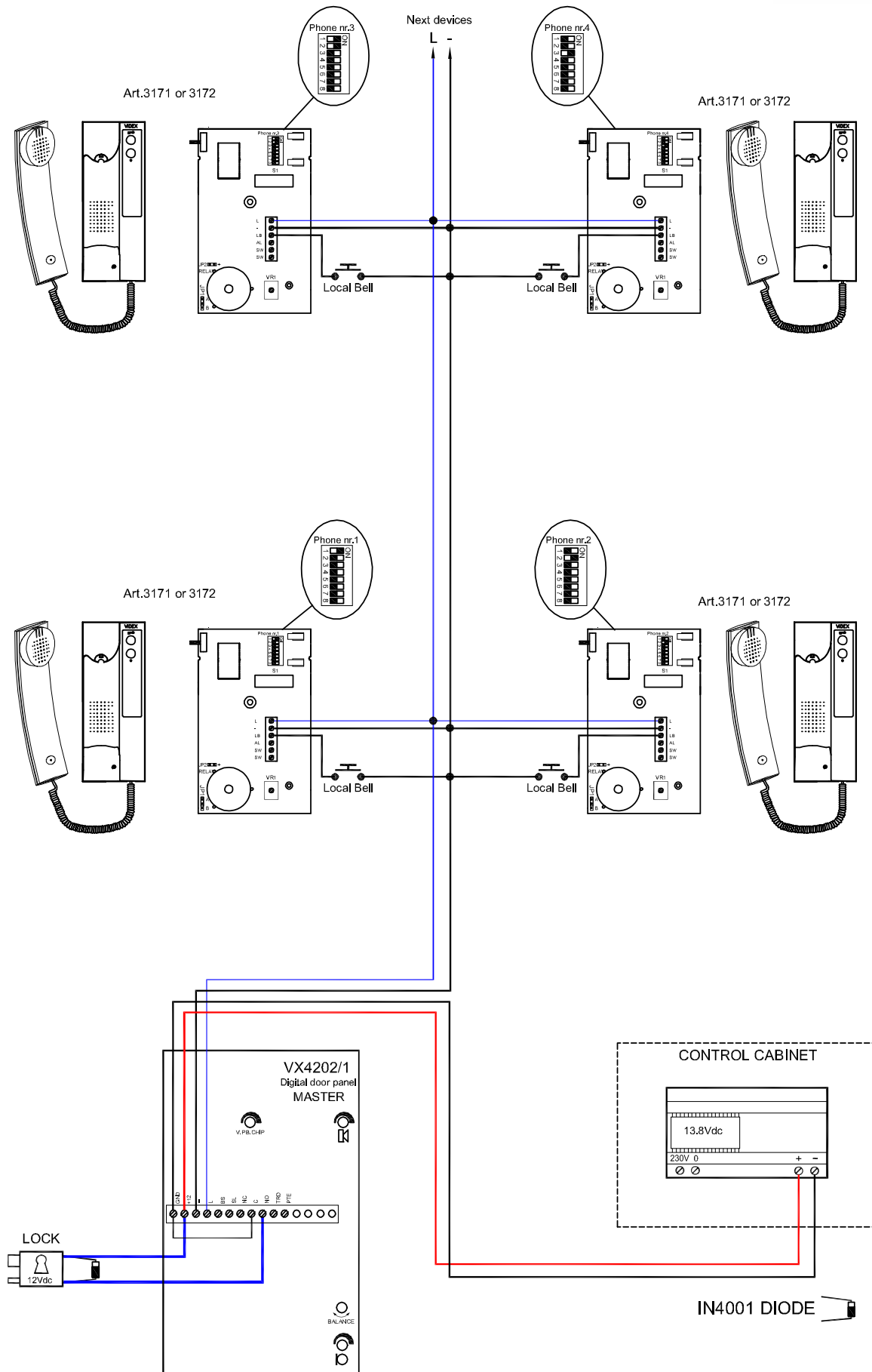

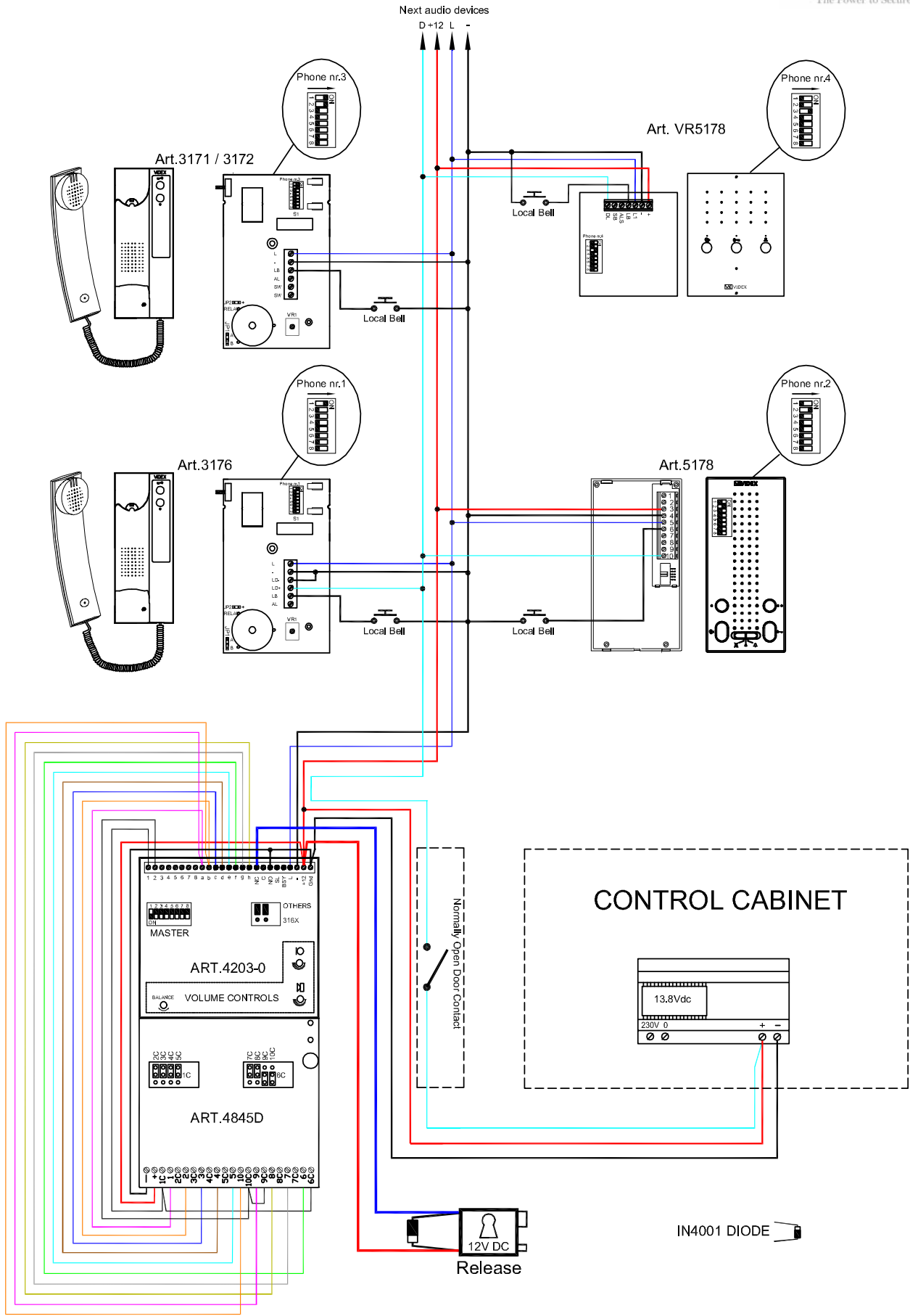

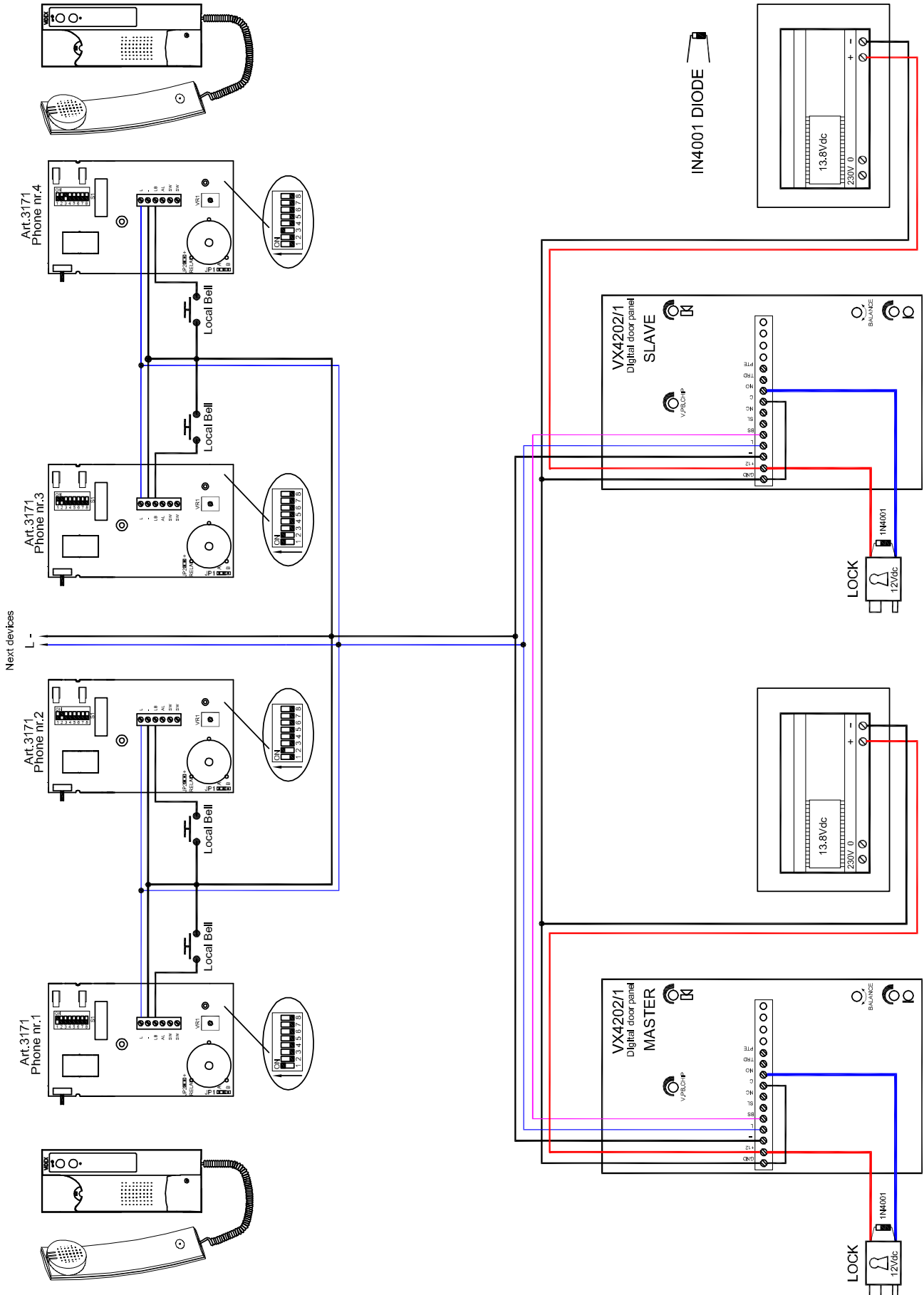

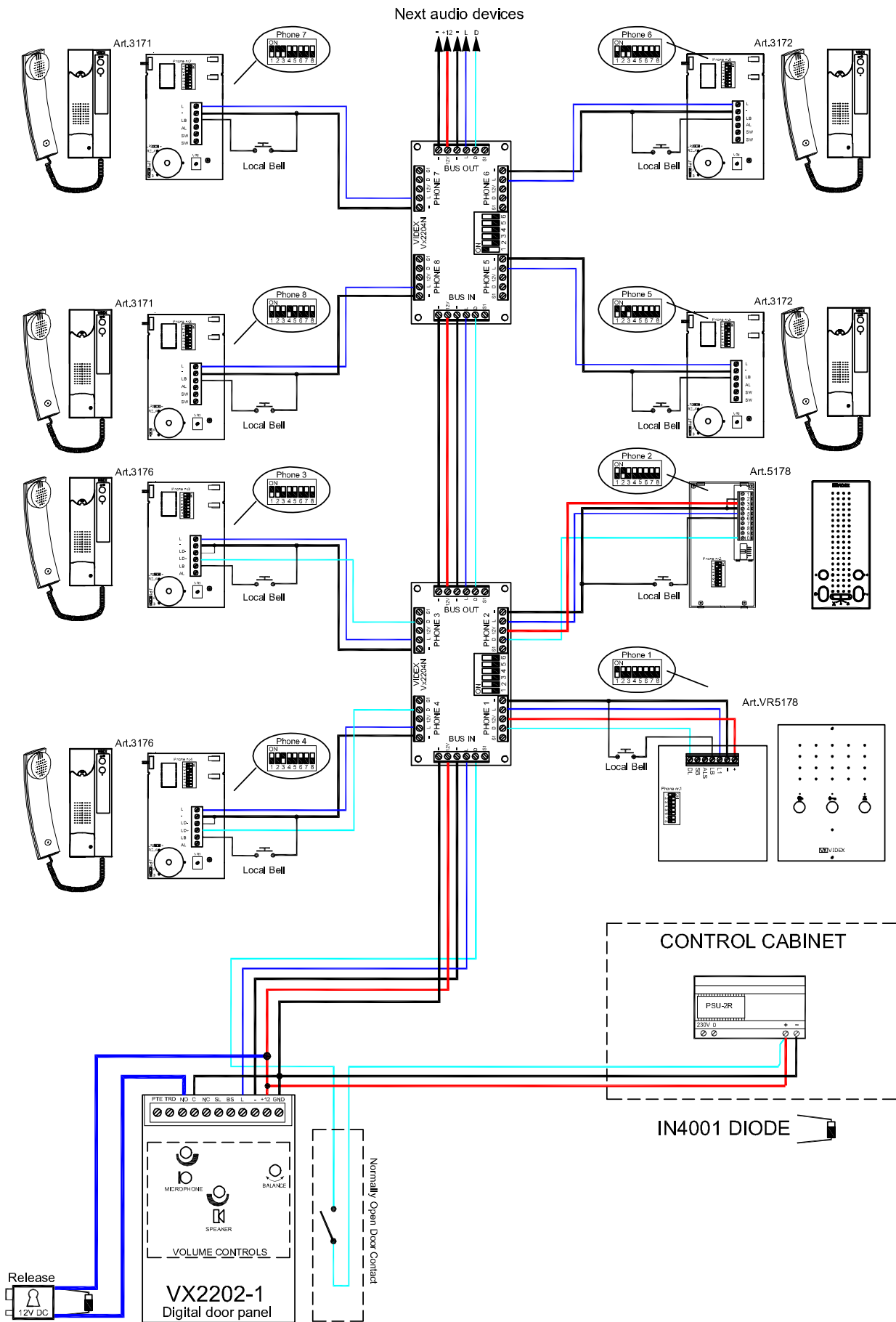

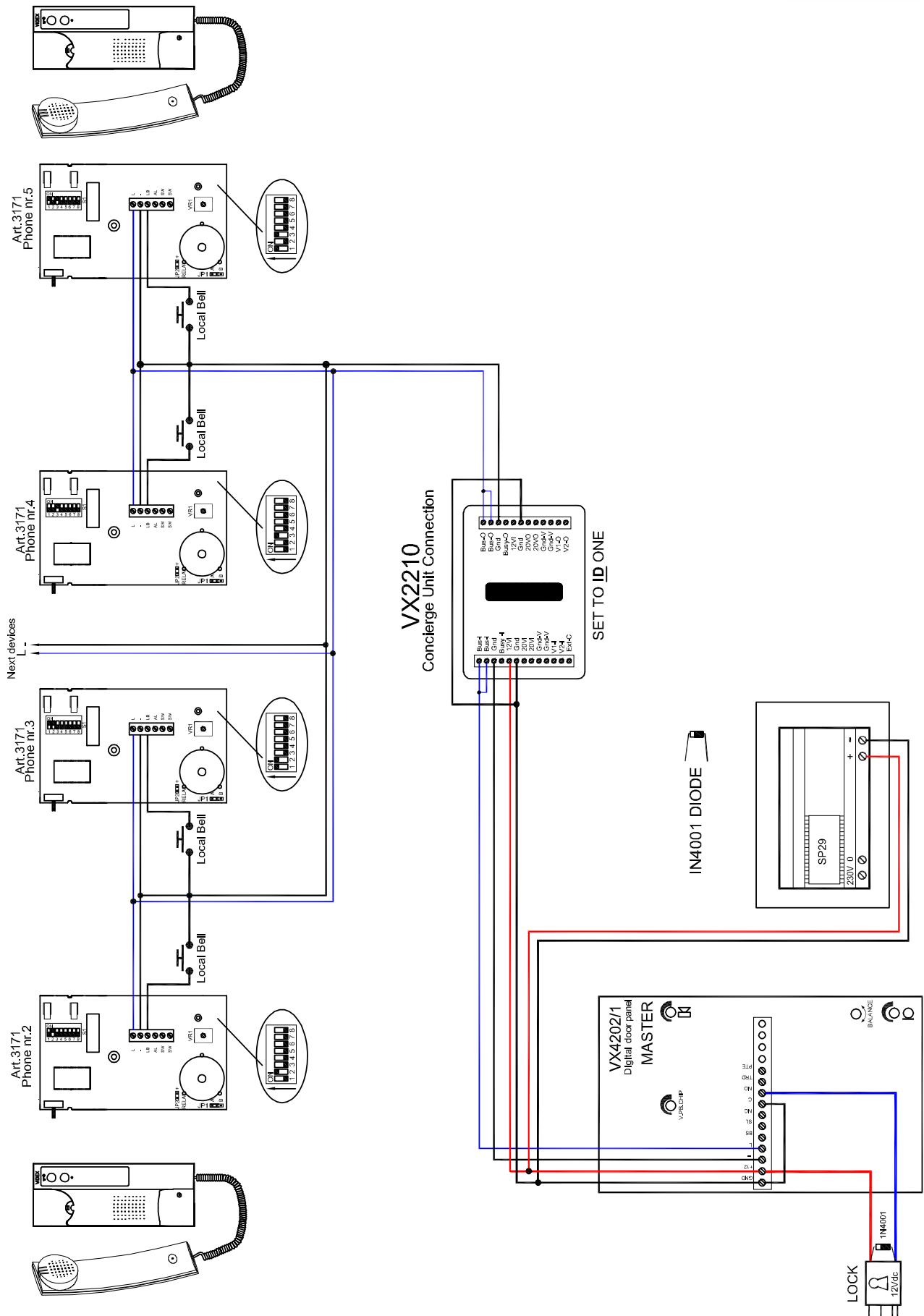

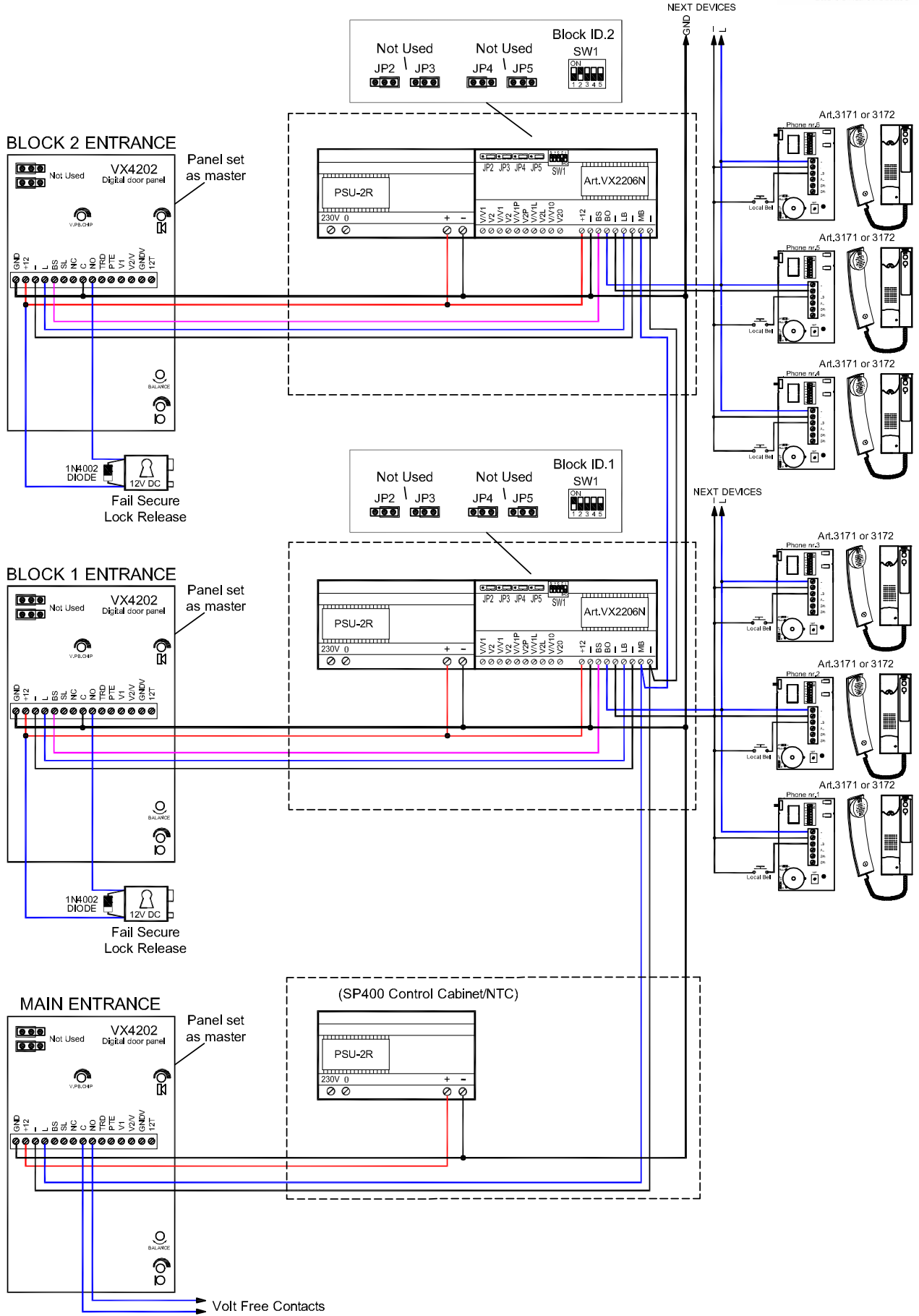

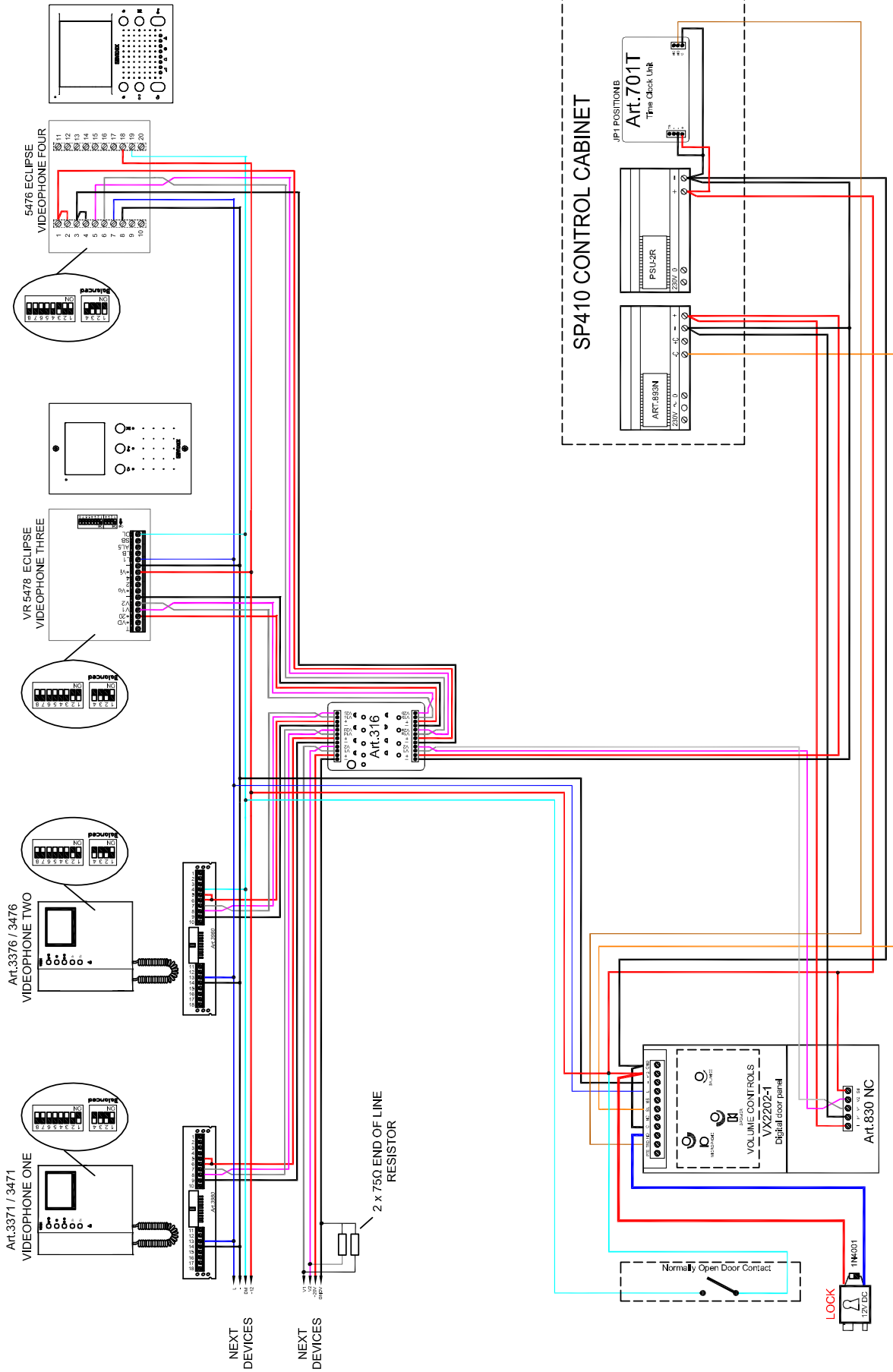

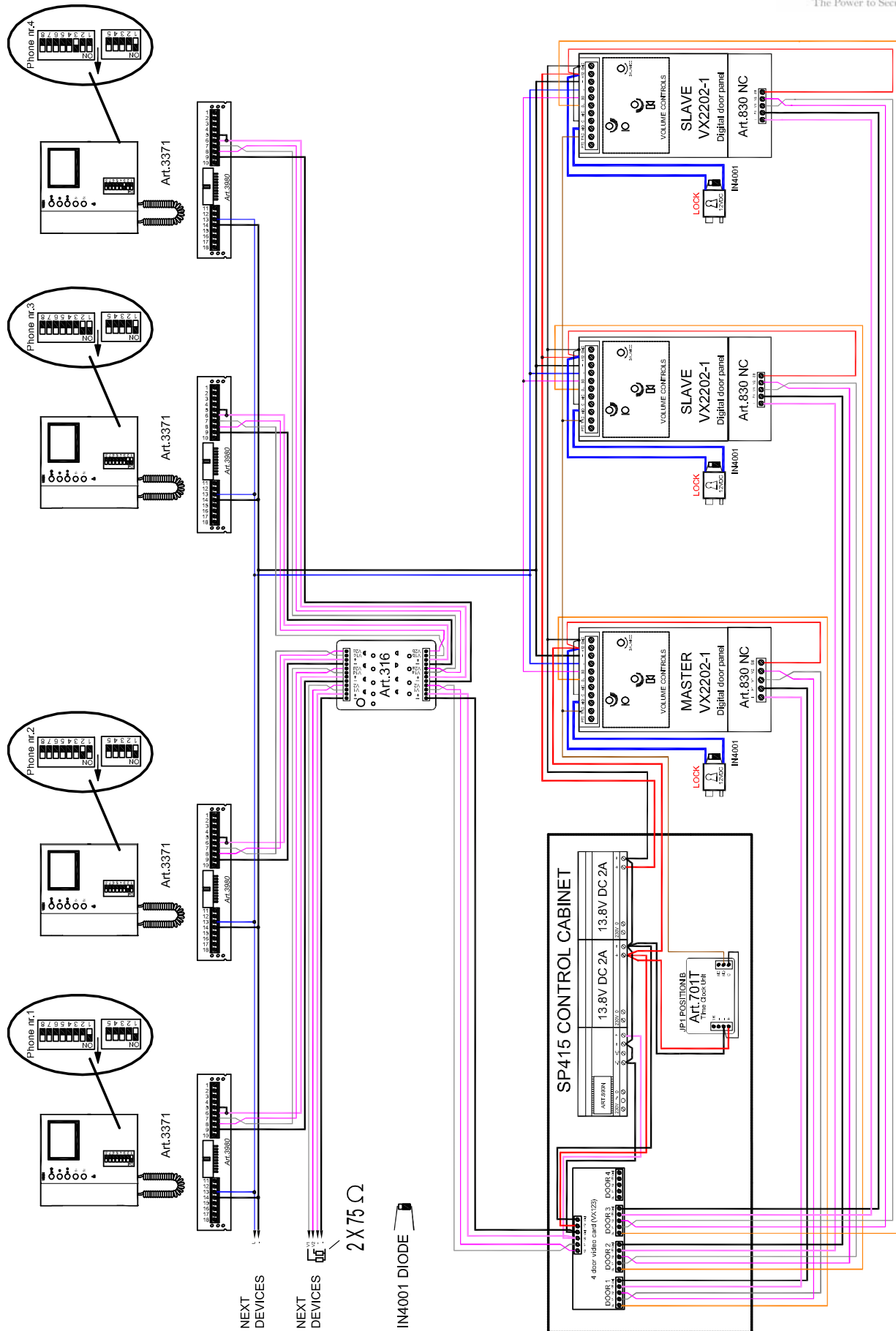

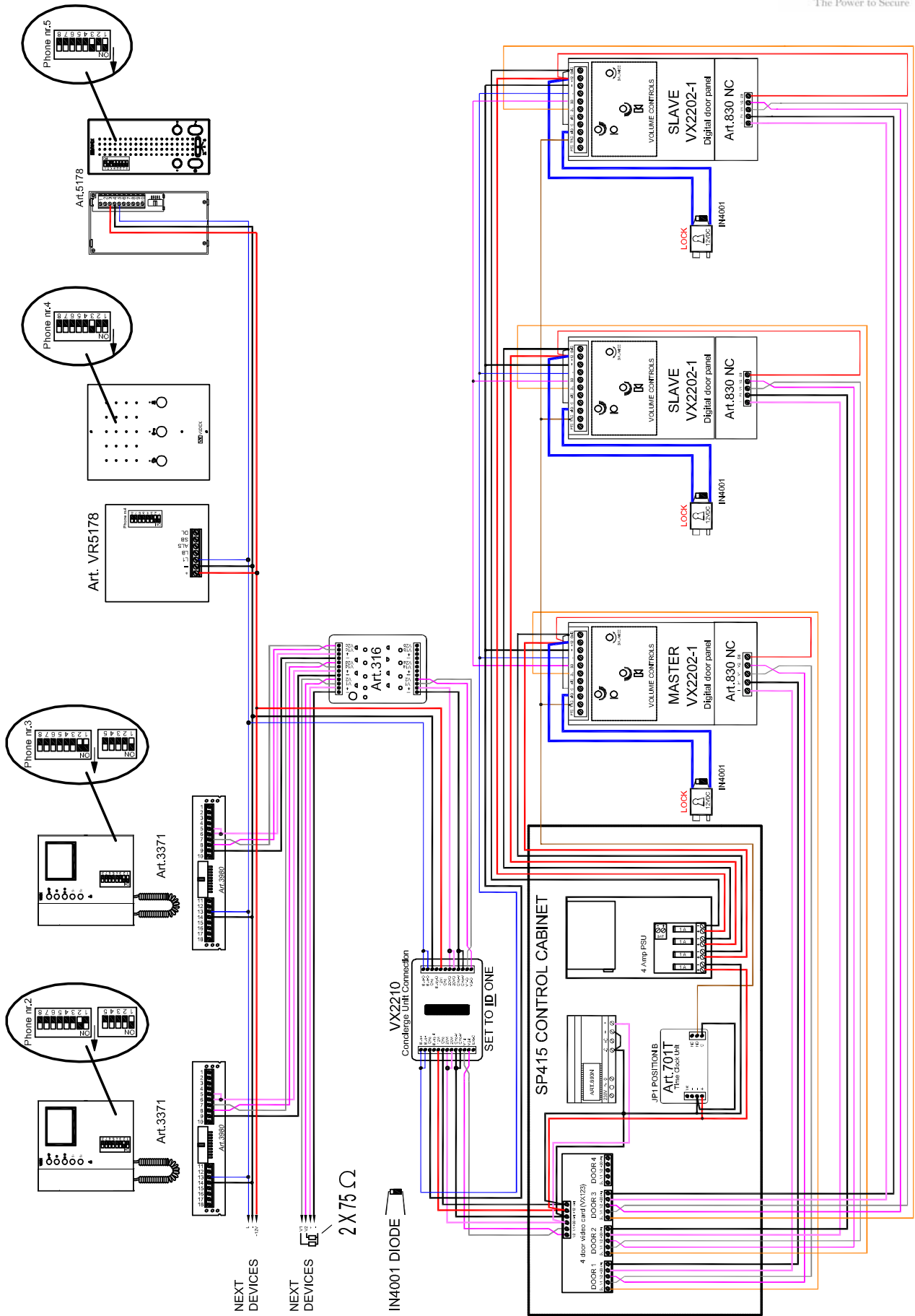

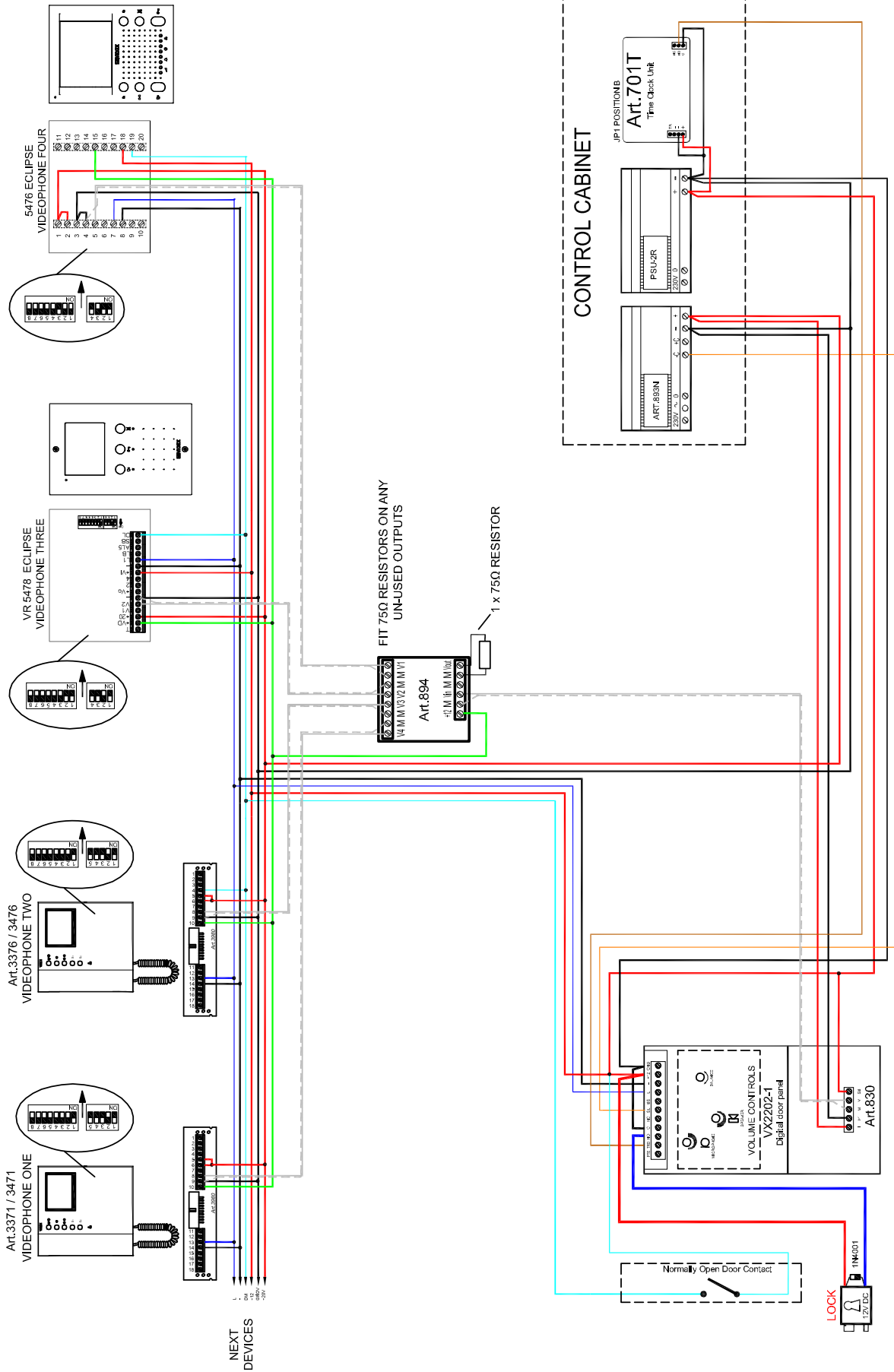

set for balanced video signal JP2 JP3
 set in end of line position JP4 JP5
 Block ID.2 SW1

set for balanced video signal JP2 JP3
 set in the open position JP4 JP5
 Block ID.1 SW1

BLOCK 2 ENTRANCE

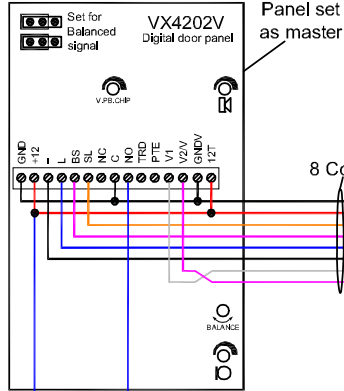

8 Cores

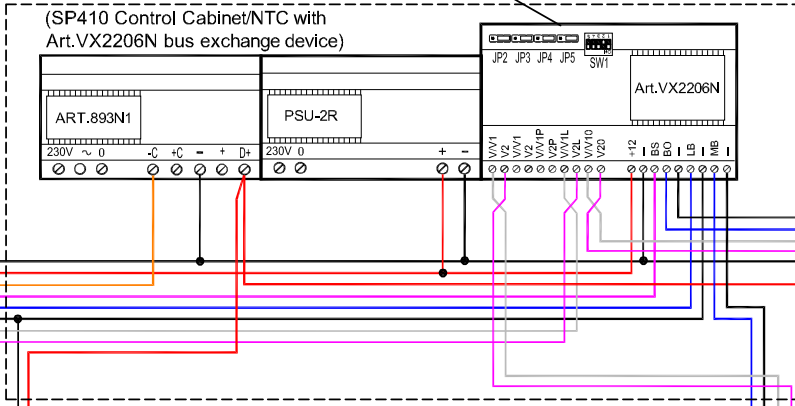

6 Cores

BLOCK 1 ENTRANCE

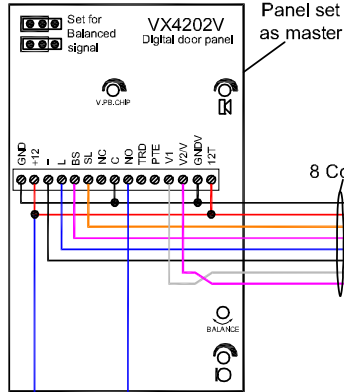

8 Cores

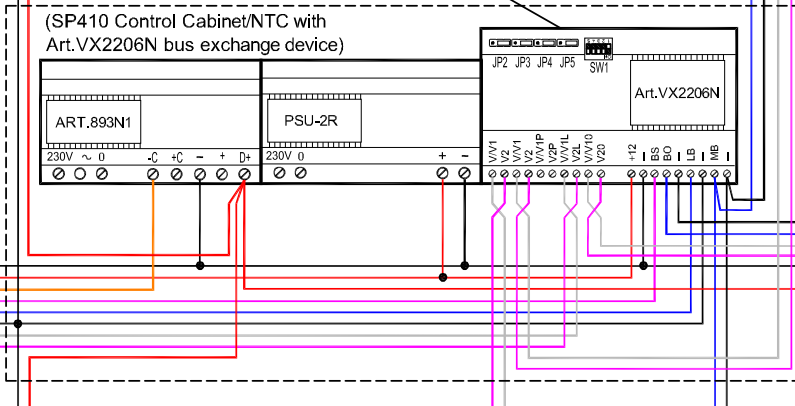

6 Cores

MAIN ENTRANCE

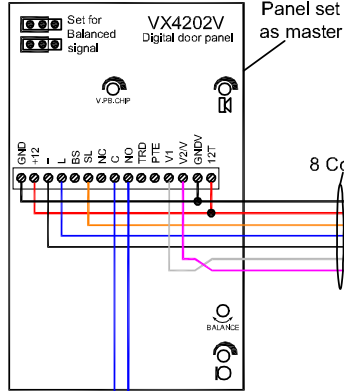

8 Cores

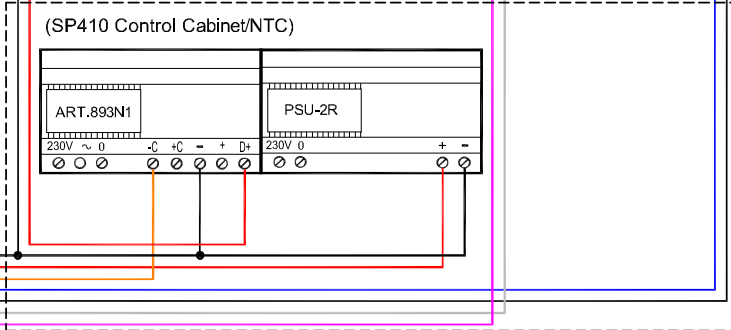

Volt Free Contacts

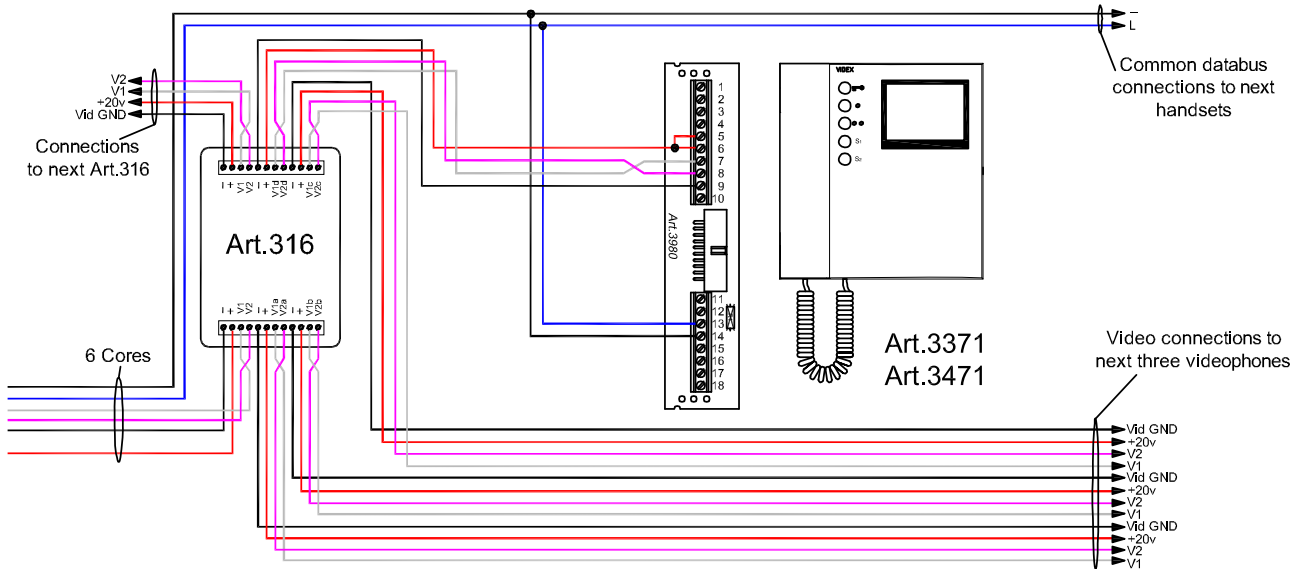
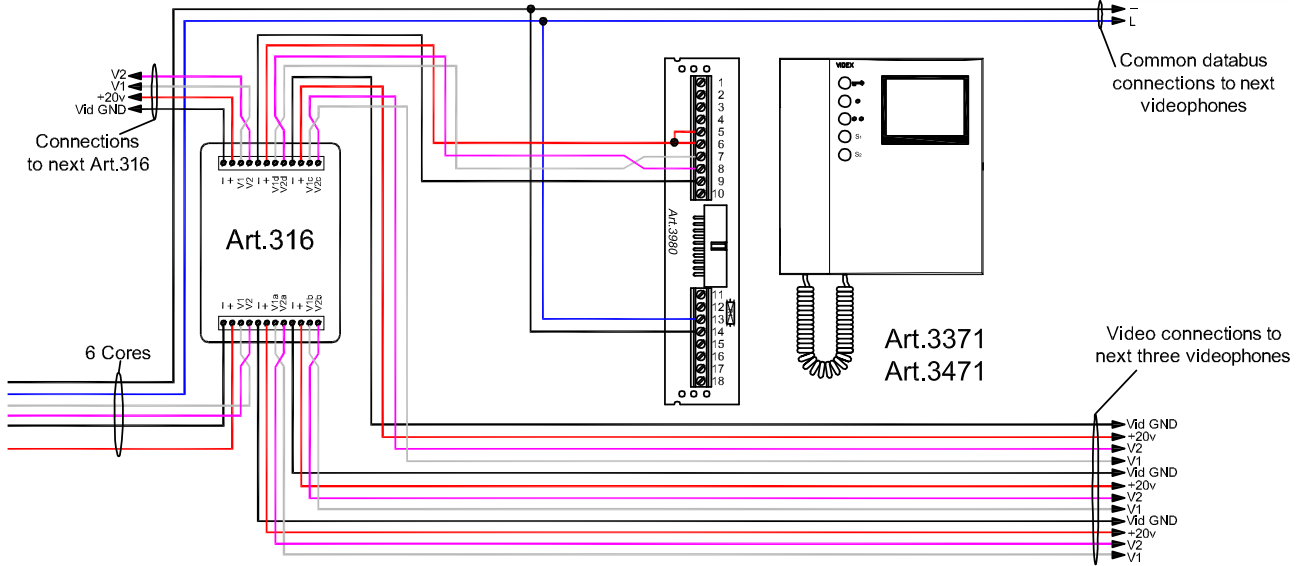

Dip-Switch Settings

Please note that shaded area represents dip-switch position

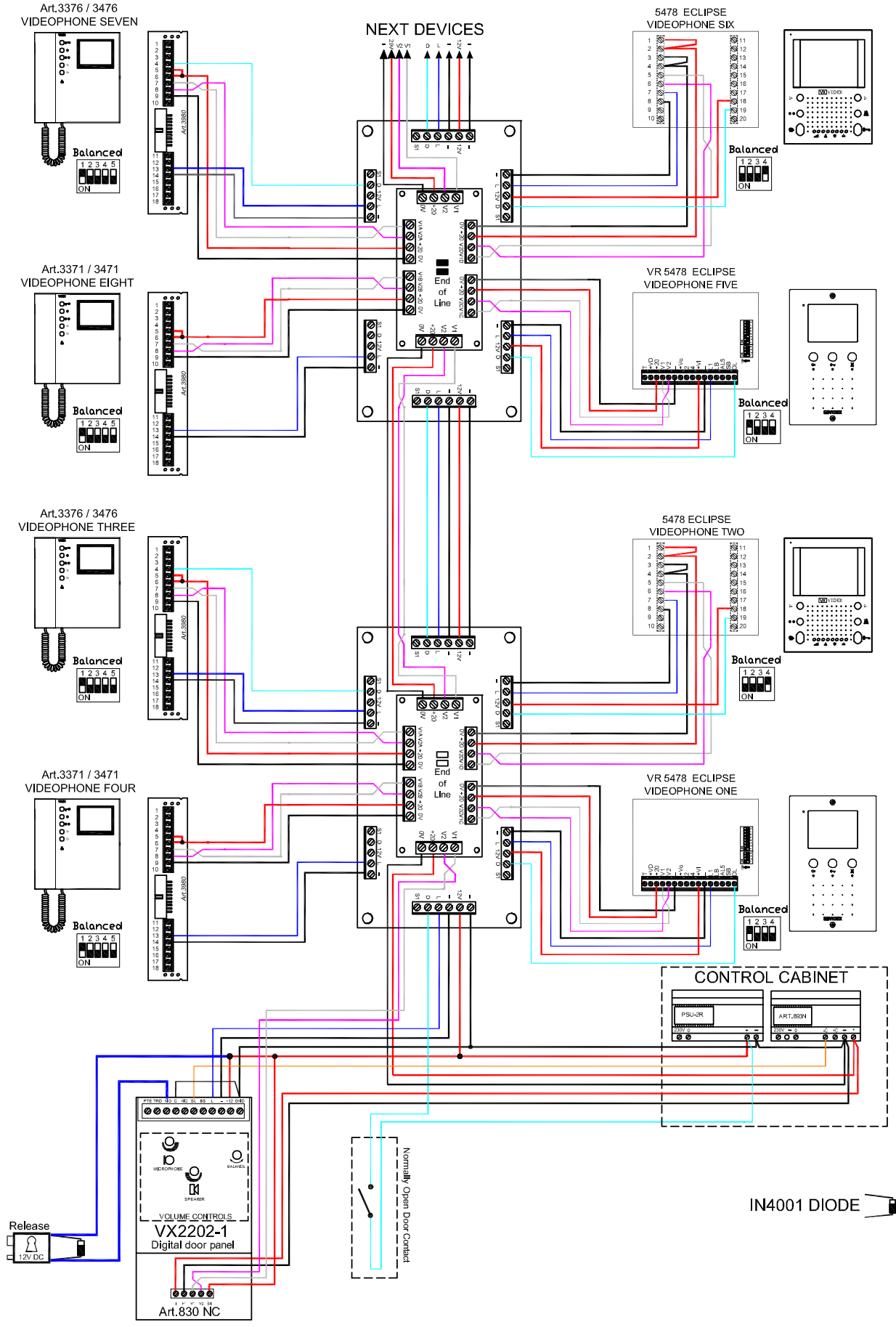

SYSTEM COMPONENTS

800 Series Digital Front Panels (2202M, 2202MR)

These units are built into a double 800 series module (stainless steel/**S** or aluminium/**A**) and have a 2 line 16 character LCD display, speaker unit and numeric keypad with either 8 alpha buttons [A-H] (VX2202/2202M) or 3 scroll buttons (VX2202R/2202MR) to navigate the "Repertory Names". A PC based programming kit is also available (**SP37**) which includes software and serial cable to simplify the programming of large installations.

Vandal resistant Digital Front Panels (SP300, SP301)

These units are based on the 800 series module electronics and have a 2 line 16 character LCD display, speaker unit and numeric keypad, and 12 gauge stainless steel facia with bezel back box.

4000 Series Digital Front Panels (4202, 4202R, 4202V, 4202RV)

The 4000 Series door panels have the same features as the 800 series version but are based on the 4000 series modular system and can also include mono or colour video within the two module design. Versions with either alpha buttons [A-F] or scroll buttons are available and include a high contrast blue back lit 2 line 16 character LCD display. The face plate is available in either mirror finish stainless steel (standard version) or matt finish anodized aluminium).

Digital panels features:

- Call up to 998 users (Version 5.0 software or later) (only 150 with 900 Series telephone);
- Call up to 255 users when using 316x telephones;
- Open the door by means of an individual personal access code
- Enter the "programming menu" (by using a programmable master code), where it is possible to assign:
 - a. Trade access code for periodic visitors such as postman etc
 - b. one or more apartment numbers for each telephone
 - c. one or more individual access codes (up to 6 digits)
 - d. User name (Scroll facility door panels only)
 - e. the device number for each outdoor station
 - f. Choose from six languages
 - g. speech play back system
 - h. speech time and door opening time (up to 255 seconds);
 - i. Automatic test mode
- Connect up to 10 entrance panels (main or secondary). An installation can consist of main entrances (Which can call all users) and block entrances (Which can only call users in these blocks). On two level systems of this type a VX2206 bus exchange device is needed per block.

The LCD display will show all relevant information during the call procedure along with acoustic signals and voice annunciation.

8000 Series Functional module (8203-0, 8203-1, 8203-2)

Built into a single 8000 series module and includes the speaker unit and interfaces to the digital bus. Up to 64 push buttons can be added to the interface using the 8843, 8844, 845 expansion button modules. (The 8203 is available with either 1 button, 2 buttons or no buttons).

4000 Series Functional Module (4203-0, 4203-1, 4203-2, 4203-1D, 4203-2D)

Built into a single 4000 series module and includes the speaker unit plus 4 LED's to provide call progress information. Up to 64 push buttons can be connected (Modules available with button options 0, 1, 2 or 4). Using the standard 4000 series expansion button modules Art.4842, 4843, 4844, 4845, 4842D, 4843D, 4844D and 4845D. The module is available with front plate in stainless steel mirror finished (standard version) or in matt finish anodized aluminium.

4000 Series Functional Module with camera (4283-0, 4283-1, 4283-1D)

Built into a single 4000 series module and includes the speaker unit, camera, plus 4 LED's to provide call progress information. Up to 32 push buttons can be connected (Modules available with button options 0, 1 or 2). Using the standard 4000 series expansion button modules Art.4842, 4843, 4844, 4845, 4842D, 4843D, 4844D and 4845D. The module is available with front plate in stainless steel mirror finished (standard version) or in matt finish anodized aluminium and also with mono or colour camera (Suffix \C for colour).

Vandal resistant Functional panels. (Art.138, VR4K2W)

The VR functional panels include the 138 amplifier module. Up to 23 call buttons can be connected and the unit benefits from all the features of the 4000 series module plus a push to exit button input.

Optional 4 way isolation PCB (2204-1)

This unit isolates the telephones from the main 2 wire bus preventing a single telephone from compromising the system. One PCB is required for every four handsets. (The L & - terminals are isolated by this PCB).

Optional 4 way isolation PCB with full isolation of all signals and bus connection. (2204N)

This unit isolates the telephones from the main bus preventing a single telephone from compromising the system. One PCB is required for every four handsets. (The L, -, +12, S1 & D terminals are isolated by this PCB). A piggy back video isolation PCB is also available for this audio isolation PCB (Available in both coax and non-coax video versions).

Non-Coax Video Distributor & 20Vdc Video PSU isolation (316I)

Video splitter PCB for no-coax video systems, One required for every four videophones. This PCB can be used as a piggy back card to the 2204N

Coax Video Distributor & 20Vdc Video PSU isolation (894I)

As above but for coax video systems.

BUS Exchanger (2206A, 2206V)

For use with two level systems with main entrances and block entrances. Enables multiple speech paths (One per block). Use 2206A for audio systems and 2206V for video systems.

BUS Exchanger (2206N)

For use with two level systems with main entrances and block entrances. Enables multiple speech paths (One per block). The 2206N allows up to 998 apartments to be called from a main entrance and up to 180 apartments per block. The unit can also be used to extend a single level system up to 998 apartments using more than one riser bus cable.

Concierge unit (2210A, 2210V)

The 2210 allows an operator to handle and to transfer the calls from and to the users. Depending on the selected operating mode (day-night-off), it is possible to carry out different functions from the concierge. For video intercom systems, it is necessary to use 2210V (As 2210A but with additional flat screen monitor).

2 wire bus to 4+1 converter (2280)

The 2280 enables the connection of either the Videx Telephone Interface (380) or the Videx apartment station (500MM) to the VX2200 system "2 wire" Bus.

Audio telephones (3171, 3172 and 3176)

3000 Series intercoms for the VX2200 Digital System. All 3 intercoms have a door-open/call to concierge button plus an electronic call tone with a 3 level volume control which can be adjusted by the user. The 3171 and 3172 have a dry contact service push button and the 3172 has a slide privacy switch. The 3176 has a timed privacy push button with red privacy LED and a green "door open" LED (The door open LED requires an additional wire).

Audio apartment stations (5178, 5178/CA and 5178/CR, VR5178)

5000 Series surface apartment stations available in white, silver or carbon fibre finishes. Including features such as half duplex handsfree speech or optional simplex speech mode, timed privacy facility with LED, door open LED and additional service buttons. Also available in vandal resistant flush.

Basic function audio telephone (3161, 3162)

3000 series low cost telephones with restricted features. The 3161 has a "door open" button and "service" button. The 3162 also includes a slide mute switch. These telephones can only be used on audio systems without isolation or a concierge.

Videophones (3371, 3376, 3471, 3476)

3000 Series videophones with coax and non coax video inputs. The 3371 (3471 for colour video) has 5 buttons: "door open"/call to concierge, camera recall/alarm and 3 service push button. The 3376 (3476 for colour video) is similar to the 3371 but also includes timed privacy with red privacy LED, door open LED (Requires one additional wire) and one less service push button.

Videomonitors (5478, 5478/CA, 5478/CR, VR5478)

5000 Series videomonitors with coax and non coax video inputs. Including colour video, timed privacy facility, half duplex handsfree speech (Optional handset kit or simplex speech option) and spare service buttons. A flush mounting kit is also available for these monitors which are also available in white, silver or carbon fibre affect finishes. Also available in vandal resistant flush.

Videophone (3678)

3600 Series videophones with coax and non coax video inputs. Colour TFT 3.5" monitor with OSD. 3 buttons: "door open"/call to concierge, camera recall/call answer and privacy. Includes both handset and handsfree speech, timed privacy facility and privacy, door open and answer LED's

Extension sounder (512D)

Extension Sounder in a white plastic wall mount box. Connects directly to the 2 wire bus.

Extension relay (512DR)

As the 512D but with a dry contact relay (24V 100mA) instead of the sounder.

Non-coax camera module (830/NC, 830C/NC)

800 series camera module with infrared illumination. "No coax" required. (Colour camera 830C/NC has white LED's as oppose to IR LED's)

Coax camera (830, 830C)

As above but for coax video systems. Use 830NC /830NC/C for non-coax camera.

Coax/Non-coax camera (4830, 4830C)

A 4000 series camera with both coax and non-coax connections. Available in mono or colour.

1A DIN Rail Power Supply Unit (521B)

For audio systems with battery back-up facility, 230Vac / 13Vdc/ac – 1 Amp.

Video Power Supply (893N1)

For video systems, 230 Vac / 20Vdc – 1 A peak current (0.8 A continuous current).

Audio control cabinet (SP400, SP405)

Lockable control cabinet for one door (SP400) and up to 4 doors (SP405) audio systems. Includes a BST/GMT time clock, PSU and facility for a backup battery.

Video control cabinet (SP410, SP415)

Lockable control cabinet for one door (SP410) and up to 4 doors (SP415) video systems. Includes a BST/GMT time clock, PSU's for both audio and video, video switching PCB (Multiple door cabinet only) and facility for a backup battery (Audio backup only).

Non-Coax Video Distributor (316, 316N)

Video splitter for no-coax video systems, One required for every four videophones.

Coax Video Distributor (894, 894N)

As above but for coax video systems.



SEDE LEGALE:

Via G. Ceresani 1 – 60044 Fabriano (AN)
Tel. 0732-626511 / fax 0732-626939
www.eqi.it

SEDE DI JESI:

Via G. Di Vittorio 4 ZIPA 2 – 60035 Jesi (AN)
Tel. 0731-202064 / fax 0731-226376
customer@eqi.it

**Sistema qualità conforme
alla norma ISO/IEC 17025
ISO/IEC 17025 compliant
quality system**

Rapporto di Prova Compatibilità Elettromagnetica n°: RP LCE031910/01
E.M.C. Test Report n°:

PIANO DELLE PROVE
TESTS PLANNING

TIPO DI PROVA <i>TEST</i>	NORMA DI RIFERIMENTO <i>STANDARD REFERENCE</i>			
Misura delle emissioni condotte <i>Conducted emissions' measurement</i>	CEI EN 61000-6-3(07)			Conforme <i>Pass</i>
Misura delle Emissioni Irradiate <i>Radiated emission's measurement</i>	CEI EN 61000-6-3(07)			Conforme <i>Pass</i>
Misura delle armoniche <i>Disturbance in supply system Harmonics' measurement</i>	CEI EN 61000-3-2 (07)			Conforme <i>Pass</i>
Misura delle fluttuazione di tensione e del Flicker <i>Voltage fluctuations' and flicker's measurement</i>	CEI EN 61000-3-3 (97) +A1 (02)+A2/IS1(06)			Conforme <i>Pass</i>
Prova di immunità a transitori/treni elettrici veloci/Burst. <i>Electrical fast transient/burst immunity test</i>	CEI EN 61000-4-4 (06) + Ec(08) CEI EN 61000-6-1(07)			Conforme <i>Pass</i>
Applicazione delle scariche elettrostatiche <i>Electrostatic discharge immunity test (ESD)</i>	CEI EN 61000-4-2 (96)+ A1 (99)+ A2 (01) CEI EN 61000-6-1(07)			Conforme <i>Pass</i>
Applicazione buchi di tensione e brevi interruzioni <i>Voltage dips, short interruptions Immunity test</i>	CEI EN 61000-4-11 (06) CEI EN 61000-6-1(07)			Conforme <i>Pass</i>
Immunità sui campi irradiati a radiofrequenza <i>Radiated, radiofrequency, electromagnetic field immunity test</i>	CEI EN 61000-4-3(07) CEI EN 61000-6-1(07)			Conforme <i>Pass</i>
Applicazione di impulso ad alto contenuto energetico <i>Surge immunity test</i>	CEI EN 61000-4-5 (07) CEI EN 61000-6-1(07)			Conforme <i>Pass</i>
Applicazione dei disturbi condotti indotti da campi a radiofrequenza <i>Conducted disturbances induced by radio frequency field</i>	CEI EN 61000-4-6 (09) CEI EN 61000-6-1(07)			Conforme <i>Pass</i>



Northern Office

Videx Security Ltd
Unit 4-7 Chillingham Ind. Est.
Newcastle Upon Tyne
NE6 2XX
TEL 0870 300 1240
FAX 0191 224 5678

Southern Office

1 Osprey
Trinity Park
Trinity Way
London
E4 8TD
FAX 0208 523 5825

TECHNICAL SUPPORT

tech@videx-security.com

TEL 0191 224 3174

FAX 0191 224 4938

<http://www.videx-security.com>