



Instruction Manual

The RAVEN is a motion sensor that utilizes microwave technology to activate automatic doors and industrial gates. The sensor features two relay outputs that distinguish between vehicle and pedestrian traffic. The RAVEN’s detection mode can be configured to approach-only, depart-only or bidirectional movement. The programmable parameters allow for the fine tuning of the sensitivity, responsiveness and relay hold time. All user settings can be adjusted directly on the sensor or by using the optional remote control.

Cautions and Warnings



Install the RAVEN according to instructions from the door operator manufacturer. Comply with all applicable codes and safety regulations.

When drilling, ensure no damage can be caused in desired mounting location. (Ex: hidden wires, waterlines, etc.)

Specifications

Operating Frequency	24.150 GHz
Detection Range	Dependent on sensor height and housing angle Max. detection range of 23 ft (7 m) x 23 ft (7 m) at an installation height of 16 ft (5 m) and a housing angle of 45°
Vertical Directionality	+/- 90° in 15° increments (up/down)
Horizontal Directionality	+/- 18° (left/right)
Mounting Height	8-23 ft (2.5-7 m)
Power	12-36 VDC or 12-28 VAC
Current Draw	50 mA @ 24 VDC
Relay Output	2 relay outputs (vehicle & pedestrian) NO/NC
Relay Hold Time	0.5 to 300 seconds (adjustable)
Relay Contact Rating	1 A @ 24 VDC/AC
Operating Temperature	-4° to 140°F (-20° to 50°C) below 90% relative humidity
Dimensions (W x H x D)	With mounting bracket – 5.16" (131 mm) x 2.87" (73 mm) x 5.35" (136 mm)
Connection	26 ft (8 m) cable
Housing Material	Polycarbonate
Weight	1.4 lbs (650 g) with cable
Environmental Rating	IP67

Ordering Information

- RAVEN Overhead Microwave Motion Sensor, includes 26 ft (8 m) of cable and two mounting screws
- RAVEN-RC Optional remote control for programming the RAVEN

Components, Controls and Indicators

1. Sensor Housing Screws
2. FUNCTION Control Button
3. SETTING Control Button
4. Hinge Screw
5. Mounting Bracket

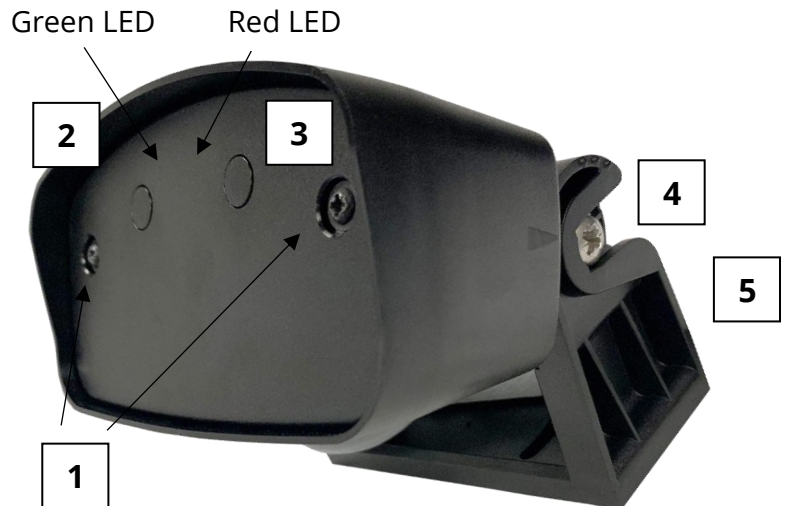

Installation

1. Loosen the hinge screw to remove the mounting bracket from the sensor housing.
2. In the desired location, install the mounting bracket at a height of 23 ft / 7 m or lower. Drill mounting holes as shown in the diagram and attach with the provided screws.

The mounting bracket can be installed at an angle (tilted left or right) to shape the detection area.

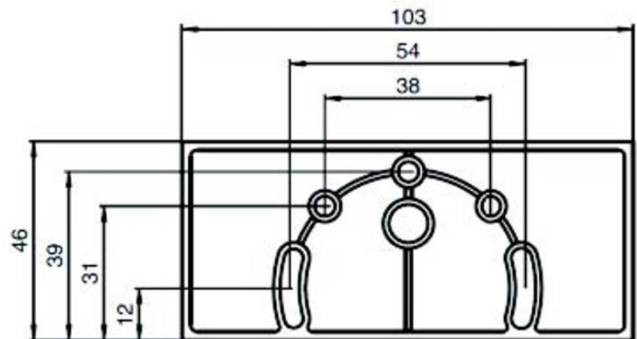

TIP:

Do not install the RAVEN:

- Facing moving objects or moving parts of a door
- Facing and closer than 6.5 feet to fluorescent lights
- Facing an area where rain could provoke water fluxes

3. Re-attach the sensor housing to the mounting bracket with the hinge screw. Adjust to the desired angle of detection (up/down in 15° increments, ex: 15°, 30°, 45°) and re-tighten the hinge screw.

Refer to Programmable Parameters for the recommended angle.

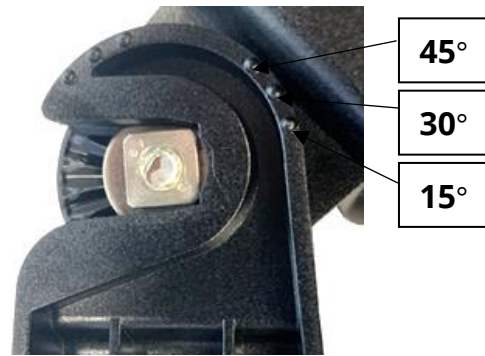

4. Wire the RAVEN to the door controller per the wiring table below.

Wire Color	Description
Brown	Power input + (12-36 VDC or 12-28 VAC)
Green	Power input - (12-36 VDC or 12-28 VAC)
White	Vehicle detection relay
Yellow	Vehicle detection relay
Gray	Human detection relay
Pink	Human detection relay

5. Apply power and allow 10 seconds for the unit to stabilize. The Red/Green LEDs will be flashing during this time. Once stabilized, the sensor's settings can be configured.

LED Indicators	
Red/Green Flashing	Sensor Initialization
Green On	Standby
Fast Green Flashes	Human detection relay activated
Fast Red Flashes	Vehicle detection relay activated
Fast Green/Red Flashes	Vehicle and human detection relay activated

Programming the RAVEN

1. Program the RAVEN using the FUNCTION and SETTING control buttons on the front of the sensor.
2. To enter programming mode, press and hold the FUNCTION button for ~ 2 seconds.

Programming Mode LED Indicators

Red LED	# of flashes indicates selected function
Green LED	# of flashes indicates current setting for selected function

For example, two RED LED slow flashes indicate the vehicle detection function followed by three GREEN LED slow flashes indicating a setting of high.

3. Use the FUNCTION control button to cycle through the nine functions. Next, press the SETTING control button to set the desired value for the selected function. The function and setting will be confirmed by the number of red and green flashes.

The setting is automatically stored every time the SETTING button is pressed.

Press and hold the FUNCTION button for ~2 seconds to exit programming mode.

Programming Example: Changing the Responsiveness Setting from Fast to Slow

1. Press and hold the FUNCTION button for ~2 seconds to enter programming mode.
2. Press the FUNCTION button seven times to switch to the responsiveness function. The RED LED should now be flashing eight times with the number of GREEN LED flashes indicating the current setting for the responsiveness.

For example, one green flash indicates a responsiveness setting of fast.

3. To change the responsiveness from fast to slow, press the SETTING button two times.
4. Eight RED LED flashes followed by three GREEN LED flashes will now indicate that the responsiveness is set to slow.
5. Press and hold the FUNCTION button for ~2 seconds to exit programming mode and to save sensor settings.

Programmable Parameters

Programmable parameters are adjusted using the control buttons or the optional remote control.

NOTE: The RAVEN will distinguish between vehicles and people. This distinction is dependent on the programmable parameters: "Vehicle Detection", "Human Detection" and "Responsiveness".

All DEFAULT factory settings are noted in TABLE 1 on the following page.



After changing the settings, confirm proper operation.

TABLE 1



FUNCTION # of red LED flashes (1-9) / remote button indicate function	SETTING # of green LED flashes indicate the setting for each function	SETTING RECOMMENDATIONS																																																												
#1 / SENS Sensitivity	Select 1-10 to increase or decrease the detection area. 1 Smallest detection area --- 6 (DEFAULT) --- 10 Largest detection area	<table border="1"> <thead> <tr> <th colspan="5">Sensor Housing Angle</th> </tr> <tr> <th>Installation Height</th> <th>15°</th> <th>30°</th> <th>45°</th> <th>> 45°</th> </tr> </thead> <tbody> <tr> <td>23 ft (7 m)</td> <td>8</td> <td>4</td> <td>2</td> <td>1</td> </tr> <tr> <td>16 ft (5 m)</td> <td>6</td> <td>6</td> <td>3</td> <td>1</td> </tr> <tr> <td>11 ft (3.5 m)</td> <td>6</td> <td>5</td> <td>4</td> <td>1</td> </tr> <tr> <td>8 ft (2.5 m)</td> <td>4</td> <td>4</td> <td>4</td> <td>1</td> </tr> </tbody> </table>	Sensor Housing Angle					Installation Height	15°	30°	45°	> 45°	23 ft (7 m)	8	4	2	1	16 ft (5 m)	6	6	3	1	11 ft (3.5 m)	6	5	4	1	8 ft (2.5 m)	4	4	4	1																														
Sensor Housing Angle																																																														
Installation Height	15°	30°	45°	> 45°																																																										
23 ft (7 m)	8	4	2	1																																																										
16 ft (5 m)	6	6	3	1																																																										
11 ft (3.5 m)	6	5	4	1																																																										
8 ft (2.5 m)	4	4	4	1																																																										
#2 / CAR Vehicle Detection	1 Low 2 Medium (DEFAULT) 3 High	<table border="1"> <thead> <tr> <th colspan="5">Sensor Housing Angle</th> </tr> <tr> <th>Installation Height</th> <th>15°</th> <th>30°</th> <th>45°</th> <th>> 45°</th> </tr> </thead> <tbody> <tr> <td>23 ft (7 m)</td> <td>1</td> <td>2</td> <td>2</td> <td>1</td> </tr> <tr> <td>16 ft (5 m)</td> <td>1</td> <td>2</td> <td>2</td> <td>2</td> </tr> <tr> <td>11 ft (3.5 m)</td> <td>1</td> <td>2</td> <td>2</td> <td>3</td> </tr> <tr> <td>8 ft (2.5 m)</td> <td>1</td> <td>2</td> <td>2</td> <td>3</td> </tr> </tbody> </table>	Sensor Housing Angle					Installation Height	15°	30°	45°	> 45°	23 ft (7 m)	1	2	2	1	16 ft (5 m)	1	2	2	2	11 ft (3.5 m)	1	2	2	3	8 ft (2.5 m)	1	2	2	3																														
Sensor Housing Angle																																																														
Installation Height	15°	30°	45°	> 45°																																																										
23 ft (7 m)	1	2	2	1																																																										
16 ft (5 m)	1	2	2	2																																																										
11 ft (3.5 m)	1	2	2	3																																																										
8 ft (2.5 m)	1	2	2	3																																																										
#3 / PER Human Detection	Select 1-7 1 Min (DEFAULT) When 1 is selected, cross- traffic control is deactivated. --- 7 Max When 2-7 is selected, cross-traffic control is activated.	<table border="1"> <thead> <tr> <th colspan="5">Detection Without Cross-Traffic Control Sensor Housing Angle</th> </tr> <tr> <th>Installation Height</th> <th>15°</th> <th>30°</th> <th>45°</th> <th>> 45°</th> </tr> </thead> <tbody> <tr> <td>23 ft (7 m)</td> <td>1</td> <td>1</td> <td>1</td> <td>1</td> </tr> <tr> <td>16 ft (5 m)</td> <td>1</td> <td>1</td> <td>1</td> <td>1</td> </tr> <tr> <td>11 ft (3.5 m)</td> <td>1</td> <td>1</td> <td>1</td> <td>1</td> </tr> <tr> <td>8 ft (2.5 m)</td> <td>1</td> <td>1</td> <td>1</td> <td>1</td> </tr> </tbody> </table> <table border="1"> <thead> <tr> <th colspan="5">Detection With Cross-Traffic Control Sensor Housing Angle</th> </tr> <tr> <th>Installation Height</th> <th>15°</th> <th>30°</th> <th>45°</th> <th>> 45°</th> </tr> </thead> <tbody> <tr> <td>23 ft (7 m)</td> <td>4-7</td> <td>2-7</td> <td>2-7</td> <td>2-7</td> </tr> <tr> <td>16 ft (5 m)</td> <td>4-7</td> <td>4-7</td> <td>4-7</td> <td>4-7</td> </tr> <tr> <td>11 ft (3.5 m)</td> <td>4-7</td> <td>4-7</td> <td>6-7</td> <td>6-7</td> </tr> <tr> <td>8 ft (2.5 m)</td> <td>4-7</td> <td>6-7</td> <td>6-7</td> <td>6-7</td> </tr> </tbody> </table>	Detection Without Cross-Traffic Control Sensor Housing Angle					Installation Height	15°	30°	45°	> 45°	23 ft (7 m)	1	1	1	1	16 ft (5 m)	1	1	1	1	11 ft (3.5 m)	1	1	1	1	8 ft (2.5 m)	1	1	1	1	Detection With Cross-Traffic Control Sensor Housing Angle					Installation Height	15°	30°	45°	> 45°	23 ft (7 m)	4-7	2-7	2-7	2-7	16 ft (5 m)	4-7	4-7	4-7	4-7	11 ft (3.5 m)	4-7	4-7	6-7	6-7	8 ft (2.5 m)	4-7	6-7	6-7	6-7
Detection Without Cross-Traffic Control Sensor Housing Angle																																																														
Installation Height	15°	30°	45°	> 45°																																																										
23 ft (7 m)	1	1	1	1																																																										
16 ft (5 m)	1	1	1	1																																																										
11 ft (3.5 m)	1	1	1	1																																																										
8 ft (2.5 m)	1	1	1	1																																																										
Detection With Cross-Traffic Control Sensor Housing Angle																																																														
Installation Height	15°	30°	45°	> 45°																																																										
23 ft (7 m)	4-7	2-7	2-7	2-7																																																										
16 ft (5 m)	4-7	4-7	4-7	4-7																																																										
11 ft (3.5 m)	4-7	4-7	6-7	6-7																																																										
8 ft (2.5 m)	4-7	6-7	6-7	6-7																																																										
#4 / OCAR Vehicle Detection Relay	<table border="1"> <thead> <tr> <th>Using Buttons</th> <th>Behavior</th> <th>Using Remote</th> </tr> </thead> <tbody> <tr> <td>1</td> <td>Vehicle forward</td> <td>4</td> </tr> <tr> <td>2</td> <td>Vehicle backward</td> <td>5</td> </tr> <tr> <td>3</td> <td>Vehicle forward/backward</td> <td>6</td> </tr> <tr> <td>4</td> <td>Person/vehicle forward</td> <td>7</td> </tr> <tr> <td>5</td> <td>Person/vehicle backward</td> <td>8</td> </tr> <tr> <td>6</td> <td>Person/vehicle forward/backward</td> <td>9</td> </tr> </tbody> </table>	Using Buttons	Behavior	Using Remote	1	Vehicle forward	4	2	Vehicle backward	5	3	Vehicle forward/backward	6	4	Person/vehicle forward	7	5	Person/vehicle backward	8	6	Person/vehicle forward/backward	9																																								
Using Buttons	Behavior	Using Remote																																																												
1	Vehicle forward	4																																																												
2	Vehicle backward	5																																																												
3	Vehicle forward/backward	6																																																												
4	Person/vehicle forward	7																																																												
5	Person/vehicle backward	8																																																												
6	Person/vehicle forward/backward	9																																																												

FUNCTION	SETTING								
# of red LED flashes (1-9) indicate function	# of green LED flashes indicate the setting for each function								
#5 / OPER Human Detection Relay	1 Person forward 2 Person backward 3 Person forward/backward 4 Vehicle forward 5 Vehicle backward 6 Vehicle forward/backward								
#6 / TIME Relay Hold Time The duration of time the relay will stay active after detection	1 0.5 seconds 2 1 second (DEFAULT) 3 2 seconds 4 3 seconds 5 4 seconds 6 5 seconds 7 10 seconds 8 15 seconds 9 20 seconds 10 25 seconds 11 30 seconds 12 60 seconds 13 300 seconds								
# 7 / OUT Relay Contact	1 Normally open (NO) contact – Closes on detection 2 Normally closed (NC) contact – Open on detection								
# 8 / STEP Responsiveness	<table border="1"> <thead> <tr> <th data-bbox="688 1192 776 1220">Setting</th> <th data-bbox="987 1192 1097 1220">Behavior</th> </tr> </thead> <tbody> <tr> <td data-bbox="688 1228 776 1255">1 Fast</td> <td data-bbox="987 1228 1403 1255">More reliable detection of people</td> </tr> <tr> <td data-bbox="688 1264 959 1291">2 Normal (DEFAULT)</td> <td data-bbox="987 1264 1300 1291">Reliable vehicle detection</td> </tr> <tr> <td data-bbox="688 1299 776 1327">3 Slow</td> <td data-bbox="987 1299 1386 1373">Reliable differentiation between vehicles and people</td> </tr> </tbody> </table>	Setting	Behavior	1 Fast	More reliable detection of people	2 Normal (DEFAULT)	Reliable vehicle detection	3 Slow	Reliable differentiation between vehicles and people
Setting	Behavior								
1 Fast	More reliable detection of people								
2 Normal (DEFAULT)	Reliable vehicle detection								
3 Slow	Reliable differentiation between vehicles and people								
# 9 Device Address If multiple RAVENS are located in close proximity, their device addresses must be set to different values. *Not possible to set with the remote control	1 Address 1 (DEFAULT) --- 15 Address 15								
RESET Reset the sensor to factory default settings. The LED flashes green/red for ~10 seconds	Press and hold the FUNCTION and SETTING buttons for ~5 seconds								

Programming with the Remote

1. Press the **Unlock Key**  on the remote control to enter programming mode.
2. The RED LED on the RAVEN will flash slowly (twice per second) when in programming mode. When the remote control has security enabled, the RAVEN's RED LED will flash fast (five times per second). This means the sensor is expecting a four-digit security code and once it's entered, the sensor's RED LED will flash slowly (twice per second).
3. Pressing a function key on the remote will cause the RED LED to flash fast (five times per second) indicating that a setting value is expected to be entered.
4. After entering a setting value, the GREEN LED will flash the same number of times as the value entered. The +/- keys can also be used to change the settings as indicated in TABLE 2.
5. Pressing the function key followed by the **Question Key**  will display the current setting.
6. To exit programming mode, press the **Lock Key**  twice.

Setting a four digit security code for the RAVEN remote control the first time:



1. Press the **Unlock Key**  followed by the **Lock Key**  on the remote control. The RED LED on the sensor will flash fast (five times per second).
2. Enter the new four-digit security code and note it. The RAVEN will return to its normal operating state, this is indicated by the GREEN LED on the sensor.
3. Press the **Unlock Key**  on the remote control. The RED LED will flash quickly (five times per second) on the sensor. Key in the security code to enter programming mode, a successful key entry is indicated by a slow flashing LED (twice per second). If the incorrect security code is entered, the RAVEN will exit programming mode and return to a normal operating state as indicated by the GREEN LED.

NOTE: No security code is required to unlock the RAVEN for 30 minutes after a power reset.

Changing the four digit security code for the RAVEN remote control:

1. Press the **Lock Key**  while the sensor is in programming mode. The RED LED on the RAVEN will flash fast (five times per second), this indicates the sensor is waiting for a new four-digit security code.
2. Enter a new four-digit security code within 60 seconds.

Locking the RAVEN's remote control programming:

1. While in programming mode, press the **Lock Key** . The RED LED on the RAVEN will flash fast (five times per second). Then press the "9" key to lock the sensor. The remote control can only be used within 60 seconds after power on.
2. While in programming mode, press the **Lock Key**  while the sensor is in programming mode, followed by "0" to clear the security code or lock.

Programmable Parameters – Remote Control Only

Change the setting of a specific function

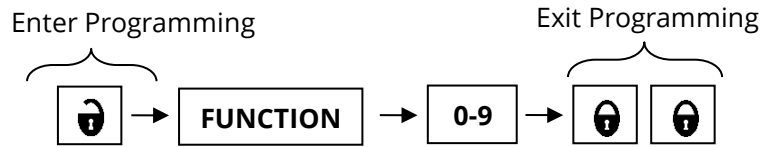

Enter programming mode with security key

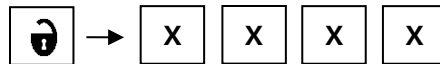

Check the current setting of a function



NOTE:

Parameters can be adjusted using + or – keys.

TABLE 2

FUNCTION # of red LED flashes (1-9) indicate function	SETTING # of green LED flashes indicate setting for each function
<p>SET-9 Factory Setting Reset</p> <p>Reset the sensor to factory settings. The LED will flash GREEN/RED for ~10 seconds.</p>	<p>9 Factory setting reset</p>
<p>F2 Permanent Relay Activation (To assist with door maintenance)</p>	<p>1 Automatic (DEFAULT) 2 Vehicle & human detection relay permanently active 3 Vehicle relay only permanently active 4 Human relay only permanently active 5 Vehicle & human detection relay permanently inactive</p>

Vehicle & Human Detection – Explanation & Examples

The RAVEN can distinguish between human and vehicle traffic in its zone of detection. This distinction is dependent on the programmable parameters: “Vehicle Detection”, “Human Detection” and “Responsiveness”. These parameters should be adjusted as explained in TABLE 1 to ensure detection accuracy.

The RAVEN has two relay outputs:

Vehicle Detection Relay - can detect a vehicle only or a vehicle/person

Human Detection Relay - can detect a vehicle or a person

EXAMPLE 1: Door operator using vehicle detection only.

Wire the vehicle detection relay to the door operator, configure as shown below.

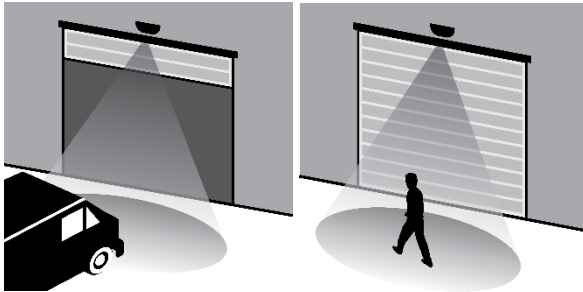

Function	Setting
Vehicle Detection Relay / OCAR	Vehicle forward (1)
Responsiveness / STEP	Normal (2)
Vehicle Detection / CAR	Dependent on height

EXAMPLE 2: Door operator controlling one industrial door and one pedestrian door.

Wire the vehicle detection and human detection relay to the door operator, configure as shown below.

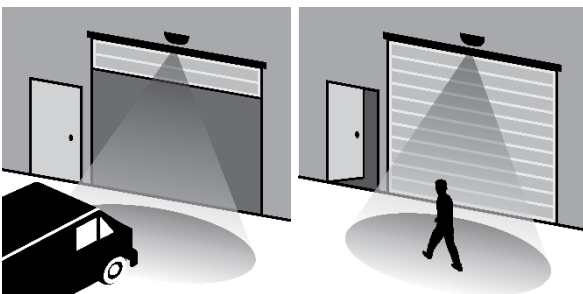

Function	Setting
Vehicle Detection Relay / OCAR	Vehicle forward (1)
Human Detection Relay / OPER	Person forward (1)
Responsiveness / STEP	Normal (2)
Vehicle Detection / CAR	Dependent on height
Human Detection / PER	Dependent on height

Troubleshooting

Symptom	Possible Cause	Solution
No LEDs on	No power or faulty power connection	<ol style="list-style-type: none"> 1. Verify the voltage is between 12-36 VDC or 12-28 VAC using a digital multimeter. 2. If voltage is present and there are still no LEDs on, the sensor is defective.
Door is detected	Sensor is angled toward door	<ol style="list-style-type: none"> 1. Adjust the sensor housing away from the door. 2. Reduce the sensitivity setting. 3. Increase the responsiveness setting. 4. Increase the human detection setting.
Remote control does not respond	Device is locked Batteries are low	Cycle power to the sensor. The sensor can now be configured without a code for 30 minutes. Replace batteries with two AA lithium batteries 1.5V (in cold weather, battery life can be reduced)
Person is mistaken for a vehicle	Vehicle detection set too low	<ol style="list-style-type: none"> 1. Increase the vehicle detection setting. 2. Increase the responsiveness setting. 3. If only detecting vehicles, reduce the sensitivity setting.
Vehicle is mistaken for a person	Vehicle detection set too high	<ol style="list-style-type: none"> 1. Lower the vehicle detection setting. 2. Increase the responsiveness setting.
Object is detected too late	Vehicle and human detection set too low	<ol style="list-style-type: none"> 1. Reduce the responsiveness setting. 2. Increase the sensitivity setting.
Object detection is too sensitive	Vehicle and human detection set too high	<ol style="list-style-type: none"> 1. Increase the responsiveness setting. 2. Reduce the sensitivity setting.
Back and forth movement of people not detected	Human detection set too low	Increase the human detection setting.
False activation	Vibrations or rain in the sensor's environment Rain	<ol style="list-style-type: none"> 1. Increase the responsiveness setting. 2. Increase the human detection setting. 3. Reduce the sensitivity setting.

Warranty

EMX Industries, Inc. products have a warranty against defects in materials and workmanship for a period of two years from date of sale to our customer.