

KIT LIBRA

Automazione per porte da garage sezionali e basculanti

Garage door opener

Motorisation pour portes de garage sectionelles et basculantes

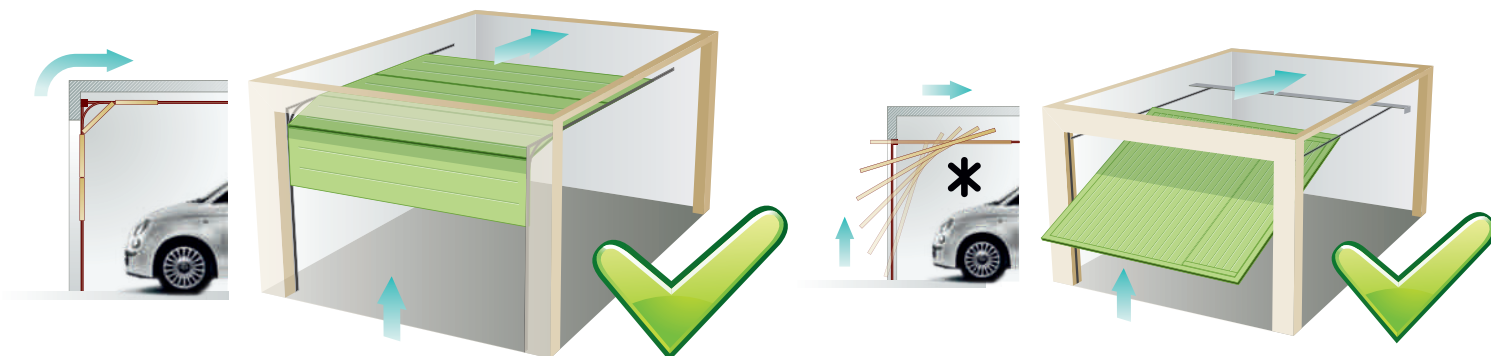

Manuale di installazione e uso - Installation and use manual -
Notice d'installation -



CONTENTS

GB

A) Components list.....	pag. 1
B) Technical data and main features	pag. 2
C) Rail assembly.....	pag. 4
D) Installation.....	pag. 5
E) Commissioning	pag. 8
F) Radio transmitters programming	pag. 13
G) Electrical wiring diagram	pag. 14
Manual release kit	pag. 16
End user guide	pag. 17













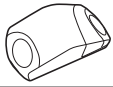

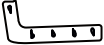

KEEP THIS MANUAL IN A SAFE PLACE

- Do not allow children to play with the automated garage door. Keep the opener's controls away from children.
- Keep watching on the door's movement and do not approach to the door until it's completely open or has come to a complete stop.
- Check regularly the automation operating condition; in particular make sure that cables, springs and fixing brackets do not show signs of wear, damages or imbalance.
- Do not use the automation if repairing or maintenance is needed. Incorrect assembly or improper use may cause serious injury!

A. COMPONENTS LIST

The automation kit consists of two packs, as shown in the tables below:

Garage door opener pack

	Description	Q.ty
	Gearmotor with incorporated control unit	1
	Instructions manual	1
	Radio transmitter	1
	Bent door arm	1
	Mounting bracket	2
	Support bracket	1
	"U" bracket	3
	Front wall fixing bracket	1
	Door fixing bracket	1
	Hexagon-head driving screw 6x15	8
	Screw with hexagonal nut 6x80	1
	Inserted pin 8x25	1
	Cotter pin 3x20	1
	Pinion	1
	Rawlplug 6x80	6
	Screw with hexagonal nut 8x20	4

RAIL PACK

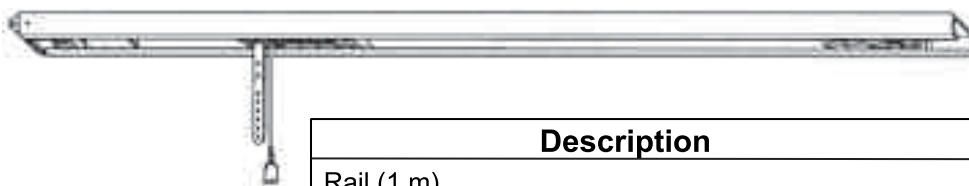

Description	Q.ty
Rail (1 m)	3
Straight door bracket	1
Chain	1
Emergency release rope	1
Trolley	1

B. TECHNICAL DATA AND MAIN FEATURES

GB

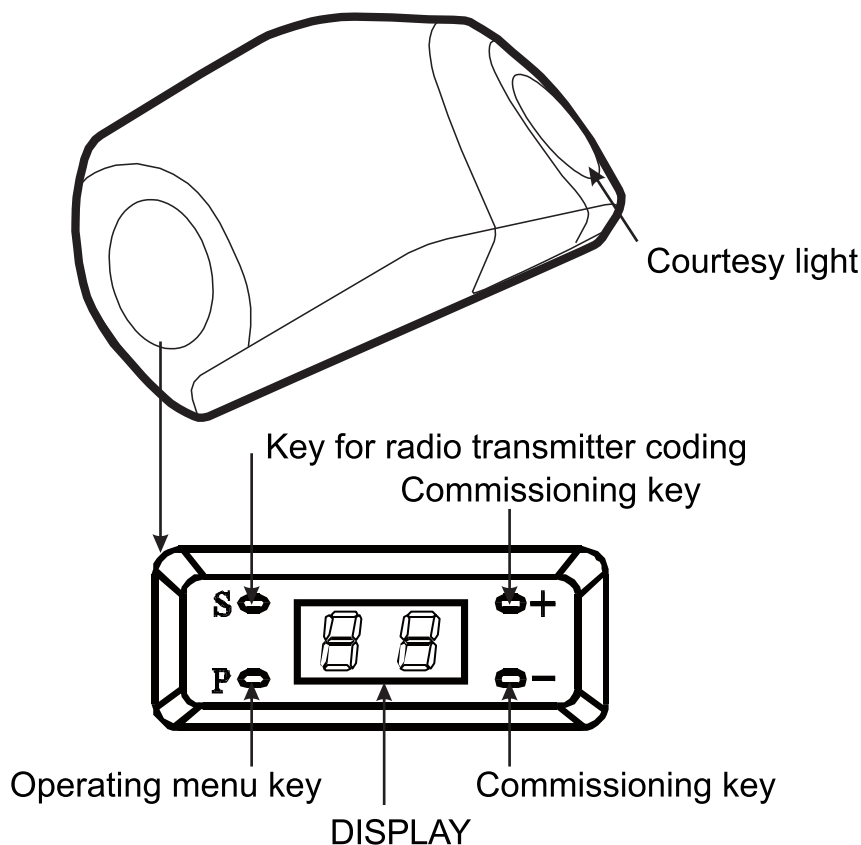

B1. MAIN FEATURES

- Door operating The start of the open-stop-close-stop cycle can be given by a single impulse of the radio transmitter.
Courtesy lamp automatically lights on and it lights off in 3 minutes.
- Motor Control unit's soft-start and soft-stop functions assure maximum noiselessness and long lasting service
- Self Diagnosis The digital display on the garage door opener allows operational monitoring and easy troubleshooting
L= Normal **F**=Interrupted **H**=Failure in reading **A**=Photocells status
- Alert function If the door stays open for more than 10minutes an alert sound can be heard. The alarm automatically stops when the door is re-closed. (see page 10)
- Power failure The door can be open manually by pulling down on the emergency release rope. (see page 5)
- Accessory devices A photocell connection is available on the control unit. (see page 14)
- Automatic closing Automatic closing time can be set from 30 to 240 seconds.
- 2000 cycles alarm When the garage door opener has run 2000 cycles, an alarm can be heard to remind the user to perform the required maintenance. (see page 11)

B2. TECHNICAL DATA

	LIBRA	LIBRA PLUS
Main power supply	230V 50Hz	
Motor power supply	24Vdc	
Lifting power	700 N	1100 N
Motor thrust	100 W	150 W
Stand-by absorption	4 W	
Door dimensions	8m ² max	12m ² max
Door height	2,4m max	
Rail length	3m	3,3m

GB

B3. INTENDED USE, GARAGE DOOR TYPE AND APPLICATIONS

Libra garage door opener is intended for sectional doors automation.

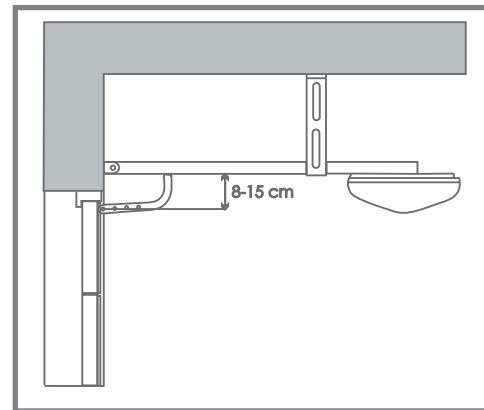
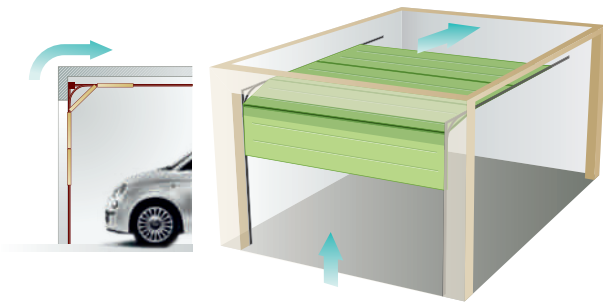

In case of counterweights balanced garage doors, an adapter bracket is needed. ARC adapter bracket can be purchased as optional accessory.

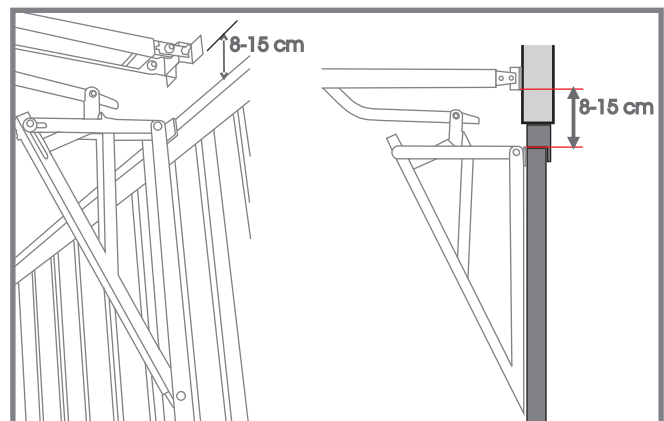
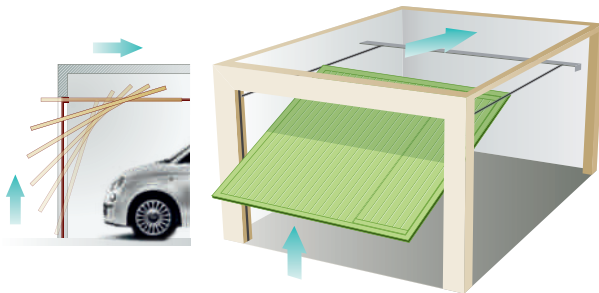

C. RAIL ASSEMBLY

- 1) Open the rail pack



- 2) Unfold the rail on the floor as shown in the picture

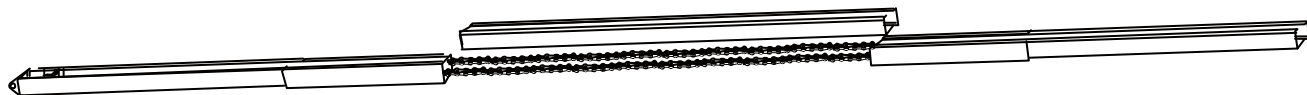

- 3) Join the rail parts together through the provided connectors in a way that the catches are in sight

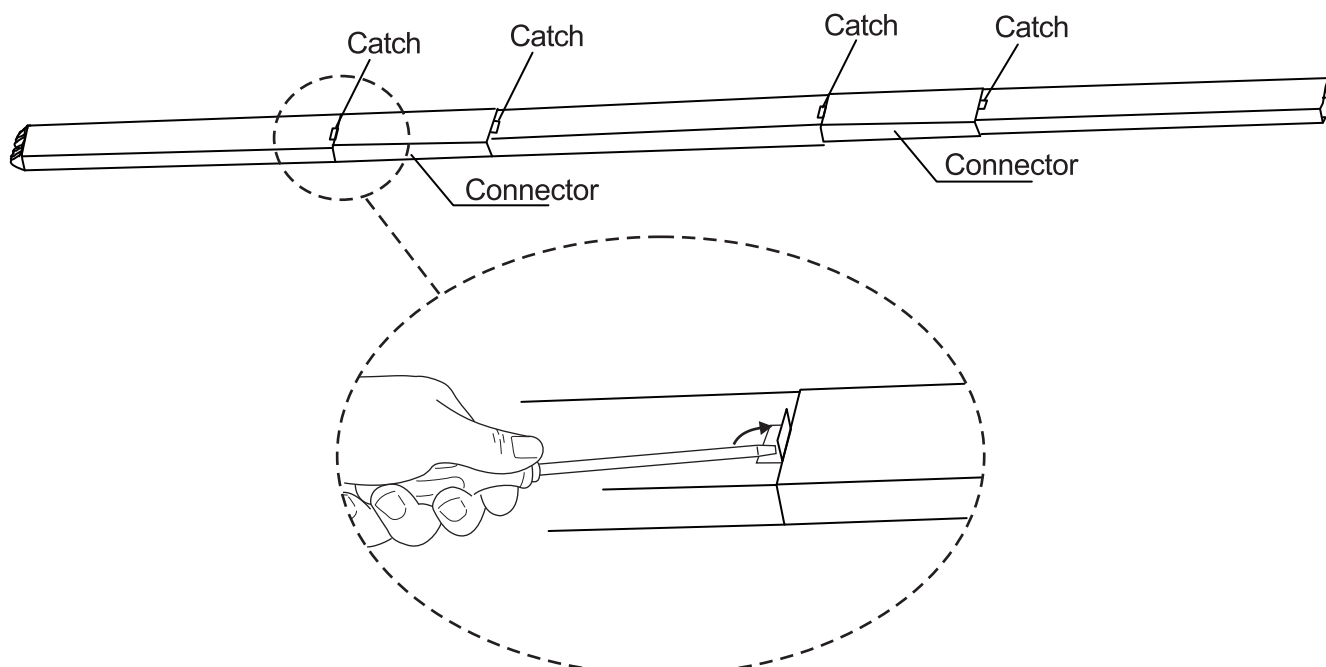

- 4) Tighten the nut with a $\varnothing 10$ sleeve

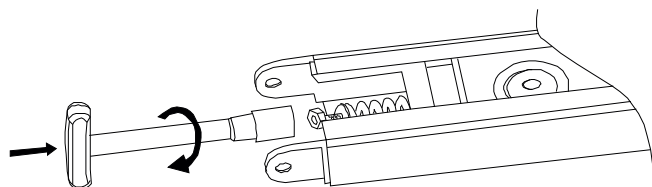

- 5) Adjust distance as shown in the picture

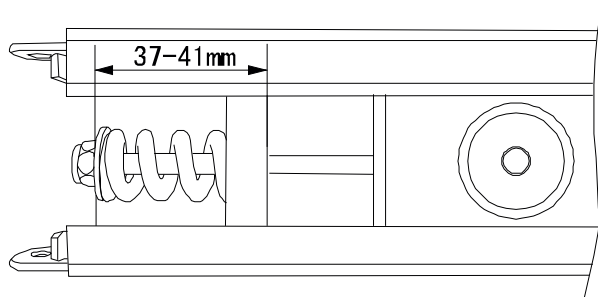

D. INSTALLATION



WARNING: FOLLOW THE MOUNTING INSTRUCTIONS CAREFULLY.
A FAULTY INSTALLATION MAY CAUSE SERIOUS INJURIES!

- Before proceeding with the installation, remove all unnecessary packages and disable any unused equipment;
- Make sure that the door can be easily opened and closed manually and check that it is in good mechanical condition and properly balanced;
- Fix the garage door opener so that the emergency release rope can be reached at an height lower than 1,8m from the floor;
- Install any automation system permanent controls within the door sight range but far enough from any moving part and at a minimum height of 1,5m;
- Affix, in outstanding position or near the permanently mounted controls, warning signals indicating the risk of being caught in the door movement;
- Clearly indicate the emergency release system;
- Once you have completed the installation, make sure that the mechanical structure is properly adjusted and check that door reverses the closing movement when detecting any obstacle higher than 40cm from the floor;
- Make sure that the door movement does not hinder public roads or footpaths;
- Make sure that the garage door opener stops any opening movement when a minimum load of 20 Kg is centrally fixed on the bottom edge of the door;

REQUIRED TOOLS

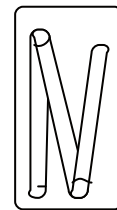
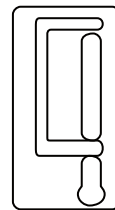
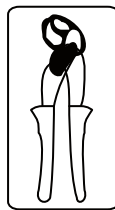
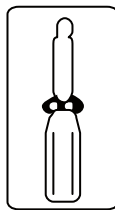
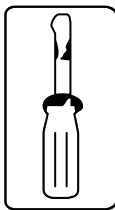
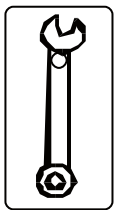

D1. GEARMOTOR ASSEMBLY TO THE RAIL

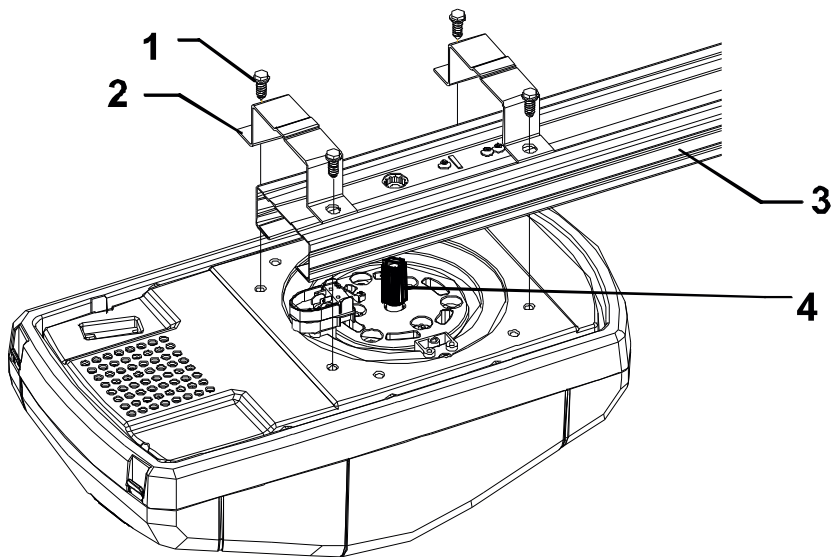

- 1 Driving screws 6x15
- 2 "U" bracket
- 3 Rail
- 4 Pinion

D2. GEARMOTOR AND RAIL FIXING

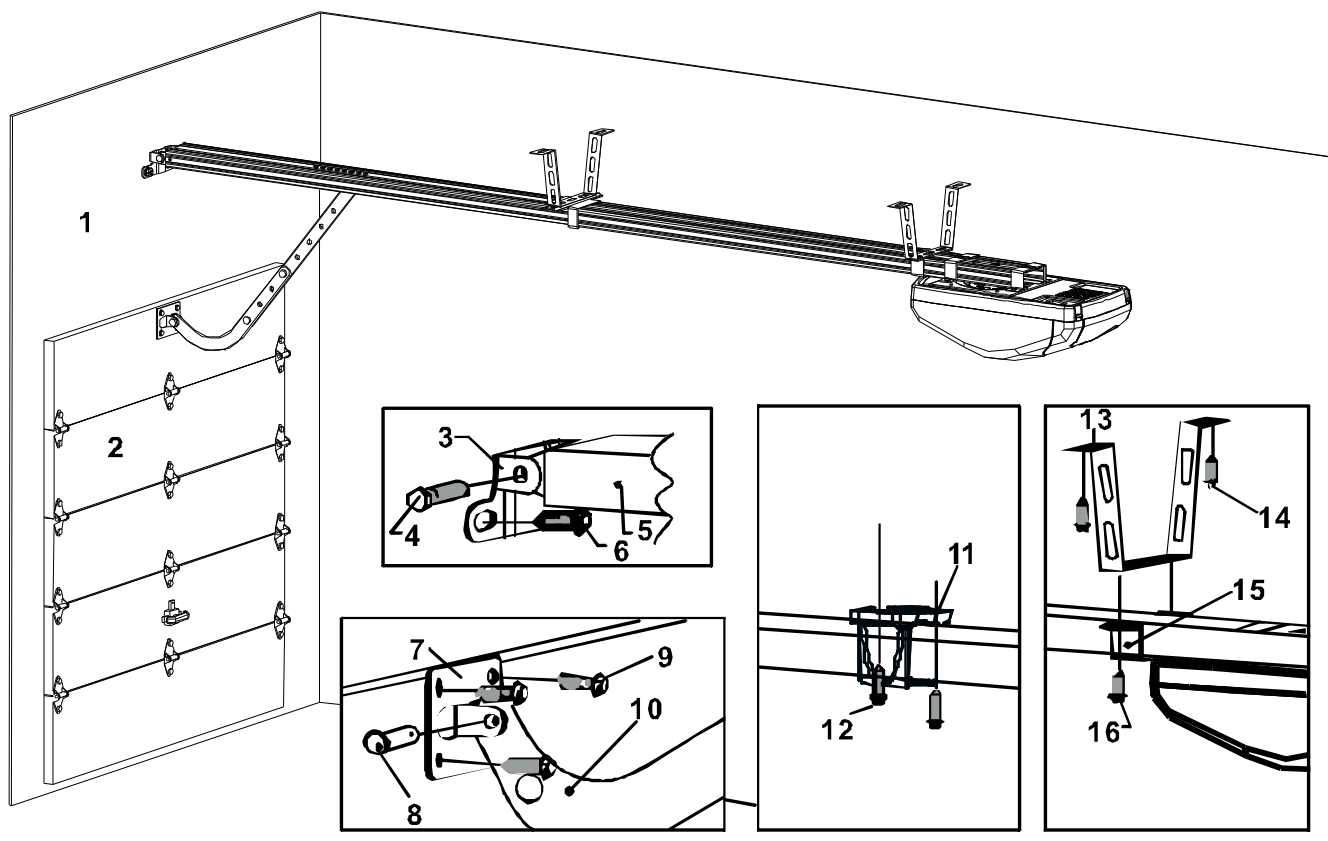

- 1 Front wall
- 2 Door
- 3 Front wall fixing bracket
- 4 Screw 6x80
- 5 Rail
- 6 Rawlplug
- 7 Door fixing bracket
- 8 Inserted pin 8x25
- 9 Driving screw 6x15
- 10 Bent door arm
- 11 Support bracket
- 12 Screw 8x20
- 13 Mounting bracket
- 14 Rawlplug
- 15 "U" bracket
- 16 Screw 8x20

D3. EMERGENCY RELEASE

IN CASE OF POWER FAILURE

- 1 If door is **CLOSED**:
Pull the rope to release the trolley and easily uplift the door.
- 2 If door is **OPEN**:
Pull the rope once more to manually close the door.

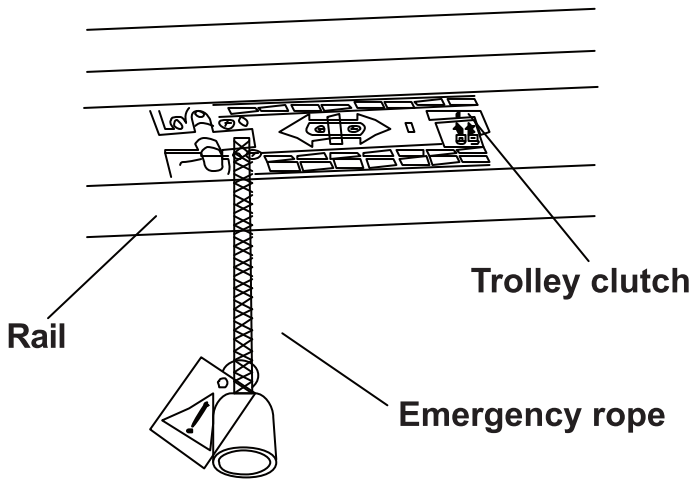

WHEN POWER RECOVERS

Give a start impulse to the garage door opener through the radio transmitter or through a permanently mounted control: the trolley clutch will be re-engaged automatically.

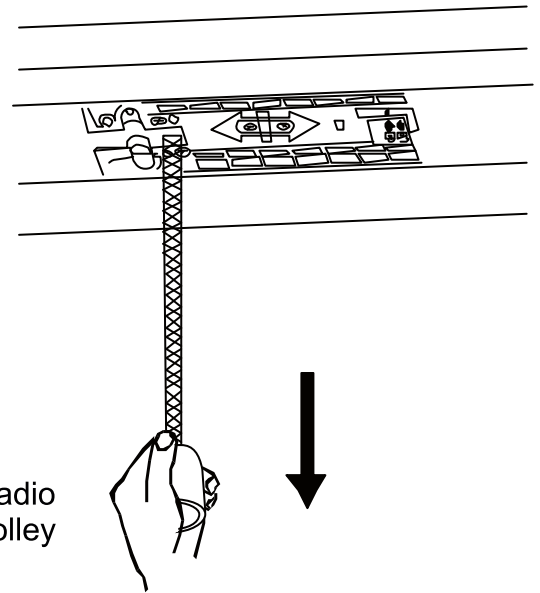

D4. MANUAL RELEASE FROM OUTSIDE

In case of garage doors with one access only (doors with external opening handle), you may also consider the installation of a release system from outside. The external release kit MLIR07 can be purchased for this purpose as optional accessory (see pag.16)

E. COMMISSIONING

PRELIMINARY PROCEDURE

- a) Lock the clutch and then gently move the door to the closed position.
- b) Power the garage door opener: the courtesy light will turn on, the display shows "0" and the control unit will "beep" once.

GB



If no instruction is given for more than 2 minutes the control unit automatically exits from commissioning mode and any previous adjustment will be deleted.

E1. DOOR'S OPENING LIMIT SETTING

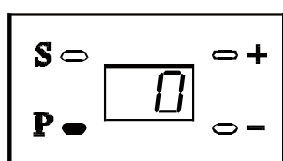

Keep pressing "P" key (about 8 seconds)

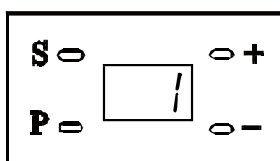

Till the control unit beeps once and the display shows "1"

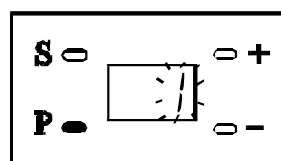

Press "P" again, "1" must flash

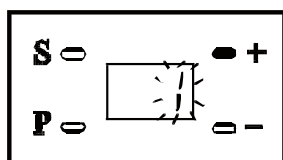

Keep pressing "+" key

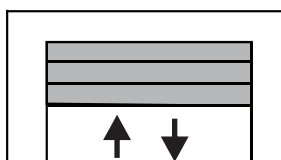

Till the door has come to the complete open position

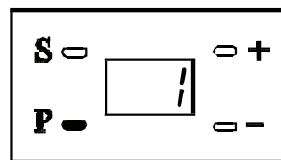

Then press "P" key again to save the setting



The saved information has no effect if this procedure is followed to set door's closing limit.

E2. DOOR'S CLOSING LIMIT SETTING

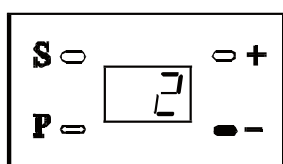

Press "-" key till the display shows "2"

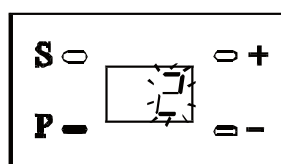

Press "P", "2" must flash

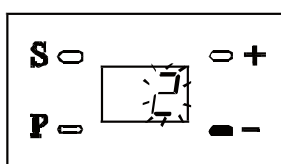

Keep pressing "-" key

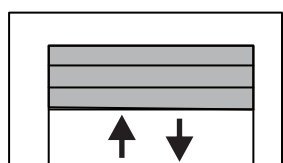

Till the door has come to the complete closed position

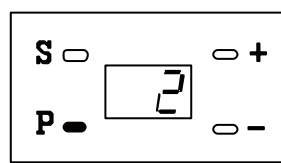

Then press "P" key to save the setting



The saved information has no effect if this procedure is followed to set door's opening limit.

E3. FORCE SETTING

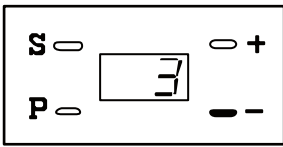

Press “-” key till the display shows “3”

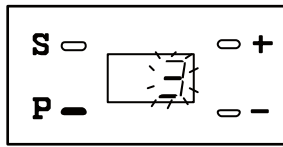

Press “P”, “3” must flash

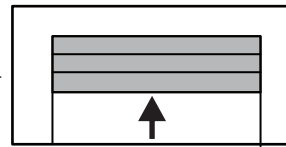

The door automatically **opens**

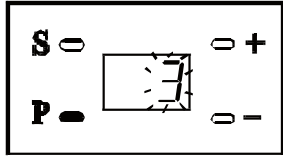

When the door stops, press “P” key twice

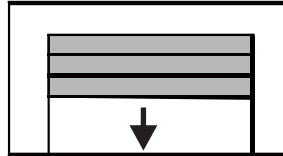

The door automatically **closes**

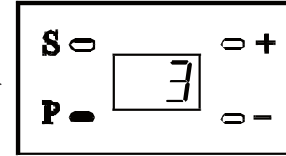

Then press “P” key to save the setting



WARNING

Once the full cycle has finished, you can press “+” key to select menu “1” and then keep pressing “P” key till the display shows “0”.

Now the basic commissioning procedure has been completed.

E4. PHOTOCELLS SETTING

This function is normally inactive from factory settings.

If you don't want to install any photocells you don't need to carry out this procedure.

You can skip to the next setting menu by pressing “-” key twice

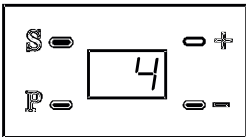

Press “-” key till the display shows “4”

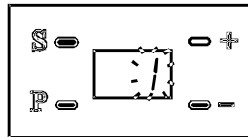

Press “P”, “1” must flash

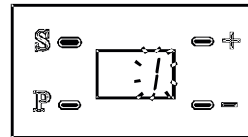

Press “+” key to activate the photocell function; the control unit will beep once

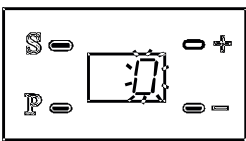

Press “-” key to turn off the photocell function; the control unit will beep twice

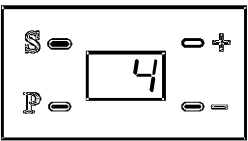

Then press “P” key to save the settings

E5. PHOTOCELLS TESTING

Note: Do not carry out this test if there is no photocells connection.
Press “-” key twice to skip to the next setting menu.

You can use this test to check the photocells operativity without exit from the commissioning procedure.

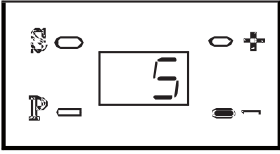

Press “-” key till the display shows “5”

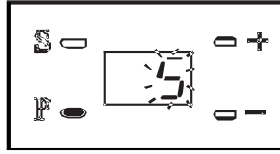

Press “P”, “5” must flash

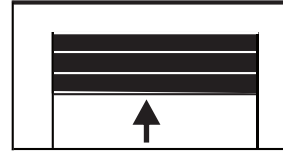

The door automatically opens

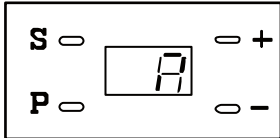

Break the photocells beam.
If the display shows an “A” then photocells have been connected properly.
If “A” does not appear on the display you have to check again the photocells connection.

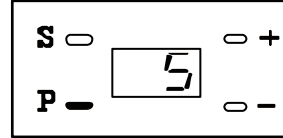

Then press “P” key to save the setting

E6. OBSTACLE DETECTION SETTING

Factory setting is 3, resetting by end user should not be required.

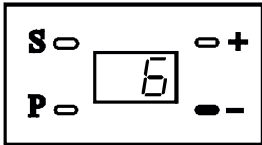

Press “-” key till the display shows “6”

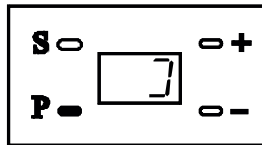

Press “P”, “3” appears on the display
Press “+” key to scroll the menu below and use “-” key to select the desired level.

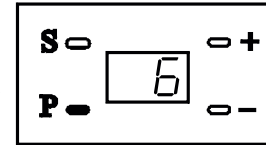

Then press “P” key to save the setting

Obstacle detection sensitivity from low to high according to the arrow direction.

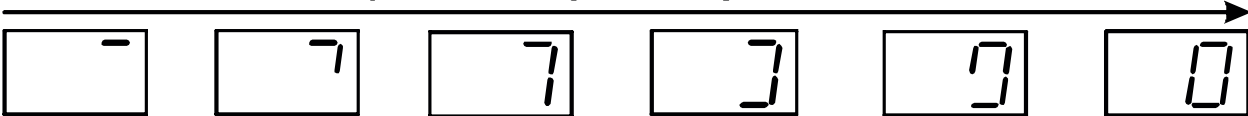

↑
Factory setting



Setting the obstacle detection sensitivity to high may affect the correct door operating (I.e. The door will reverse the movement.)

E7. DOOR OPEN ALARM SETTING

The factory setting is "OFF".

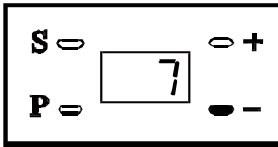

Press "-" key till the display shows "7"

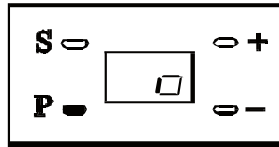

Press "P"

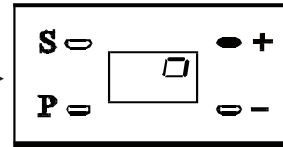

Then press "+" to set the alarm function **ON**
Or press "-" to set the alarm function **OFF**

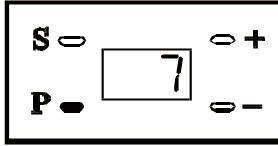

Then press "P" key to save the setting



E8. AUTOMATIC CLOSING TIME SETTING

This function is normally **OFF** from factory settings.

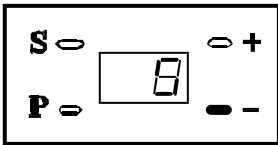

Press "-" key till the display shows "8"

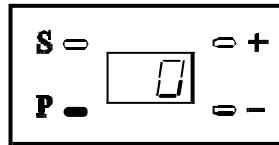

Press "P" key till the display shows "0" to set the automatic closing function **ON**

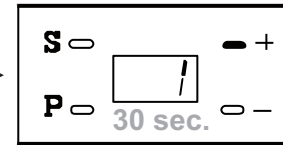

Press "+" till the display shows "1" to set the automatic closing time at 30 seconds

Press "+" or "-" to set the automatic closing time according to the following chart: 8 means 240 seconds (maximum setting), 7 means 210 seconds and so on...

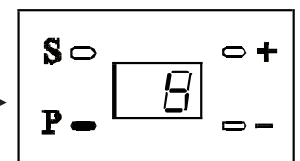
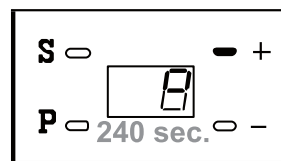
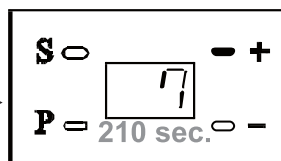
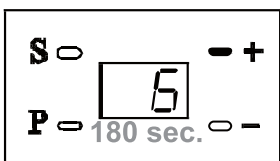
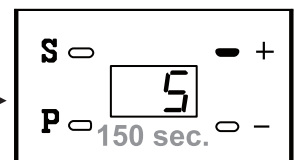
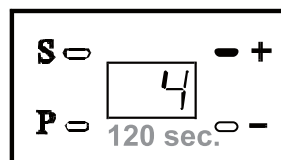
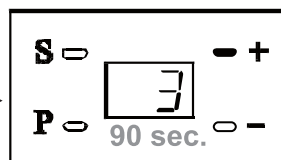
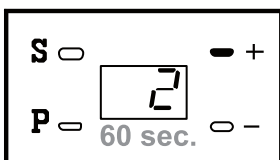

Then press "P" key to save the setting

E9. 2000 CYCLES ALERT SETTING

This function is normally **OFF** from factory settings.

To set a warning sound when the garage door opener reaches 2000 cycles, please carry out the following procedure:

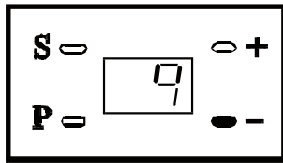

Press "-" key till the display shows "9"

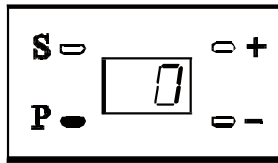

Press "P" key, the display shows "0" to mean that the 2000 cycles alert is **OFF**

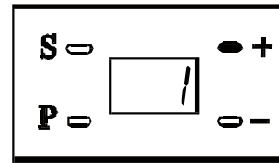

Press "+" key till the display shows "1" to set the 2000 cycles alert **ON**

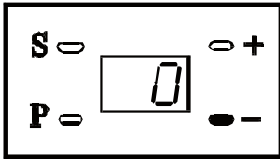

Press "-" key till the display shows "0" to set the 2000 cycles alert **OFF**

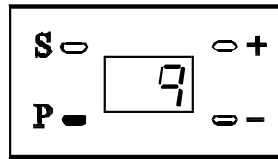

Press "P" key to save the settings



Exit way to alert sound down: cut off the power supply and then turn it on again

E10. RADIO TRANSMITTERS SELECTION

Please follow this procedure to select the radio transmitter you are using:

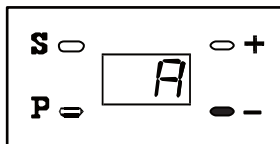

Press "-" key to select "A"

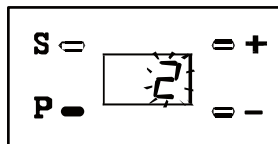

Press "P", the display shows the model of radio transmitter selected

Shows "2"=  random code radio transmitter model MYKEY

Shows "1"=  radio transmitter with dip-switches TX4334

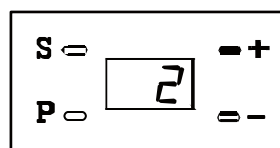

In case press "+" or "-" to change the selection of the radio transmitter model

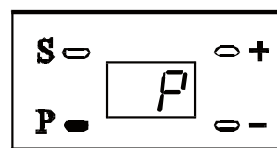
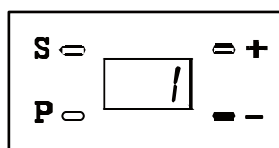

Press "P" to save the settings

E11. COMMISSIONING FINALIZING

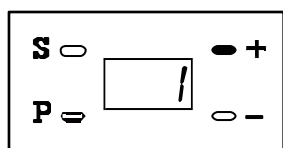

Press "+" to select "1"

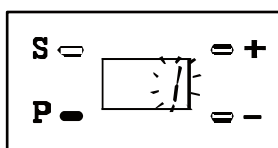

Keep pressing "P" for 8 seconds

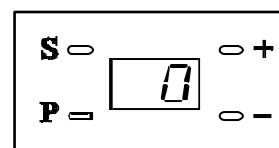

The display "0" and control unit exit the commissioning mode.



N.B. You must carry out this finalizing procedure, otherwise all the previous settings will be lost.

F. RADIO TRANSMITTERS PROGRAMMING

F1. CODING

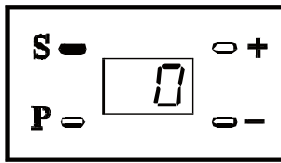

Keep pressing "S" till a "0" appears in the left side of display

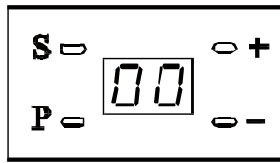

Press any key of the radio transmitter twice before the "0" disappears
Once the radio code has been correctly stored, you will hear a "beep".



Now the coding procedure is completed. Make sure that the radio transmitter has been successfully coded by pressing the radio transmitter key: the door should move.

F2. DECODING

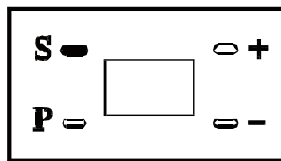

Keep pressing "S"

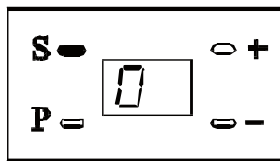

till "0" appears in the left side of display

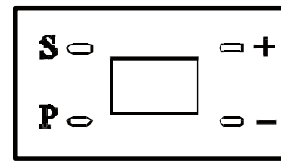

Hold on pressing "S" till the "0" disappears from the display

All radio transmitters have now been decoded.

To operate again the garage door opener you need to re-code radio transmitters



N.B.: For security reason all transmitters have to be decoded if one of them goes lost.

WIRING DIAGRAM

GB

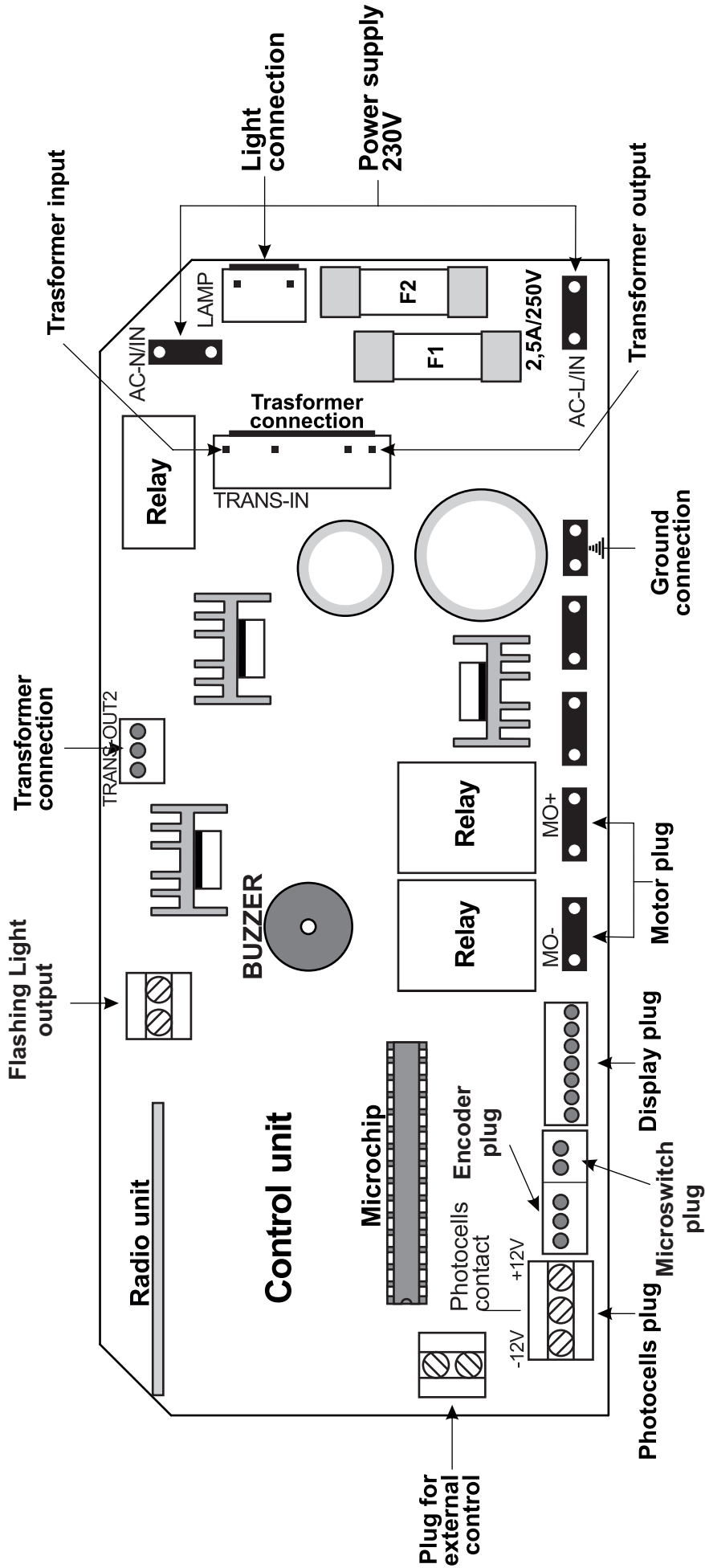

PHOTOCELLS WIRING DIAGRAM (Optional devices)

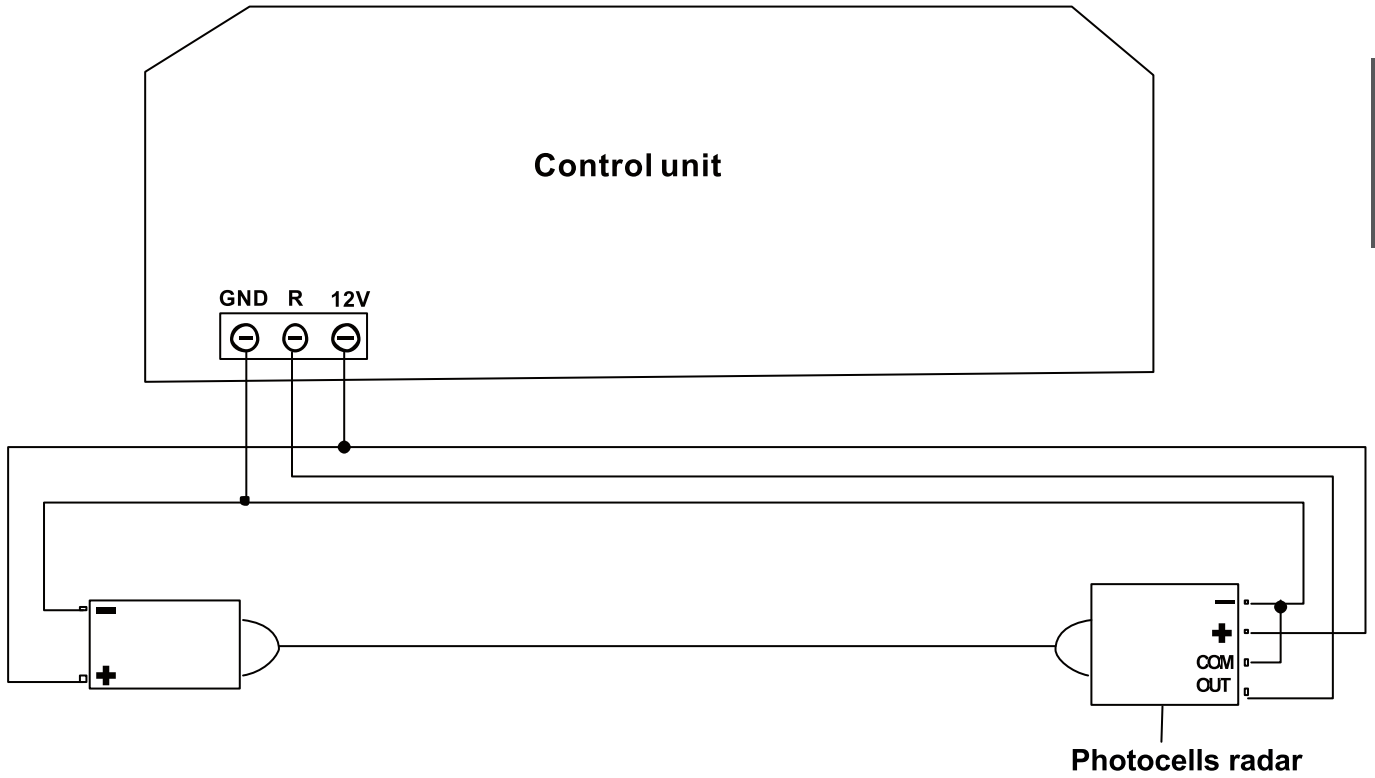

WARNING

Breaking the photocells beam while the door is closing immediately stops the movement, while it doesn't affect in opening.

MANUAL RELEASE KIT

SECTIONAL doors

- 1) Open the door wide.
- 2) Place the thin steel cable with end-ball in the pulling trolley (Fig. A).
- 3) Thread the steel cable into the rubber sheath and insert it in the eyelets of the anchoring door bracket (Fig. B).
- 4) Fasten the steel cable directly to the lock catch (Fig. C1) or to the door's handle by piercing it (Fig. C2).
Make sure that the steel cable's tension is suitable to operate the release when twisting the handle.
- 5) In case, cut the extra cable away.



Warning: Perform the manual release operation only when the door is not moving.

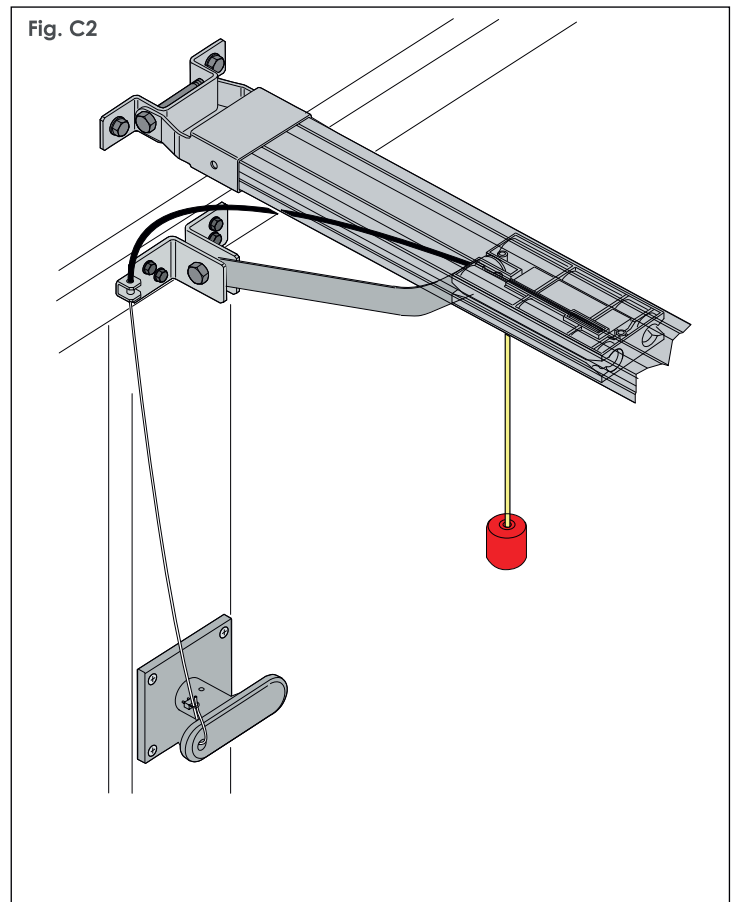
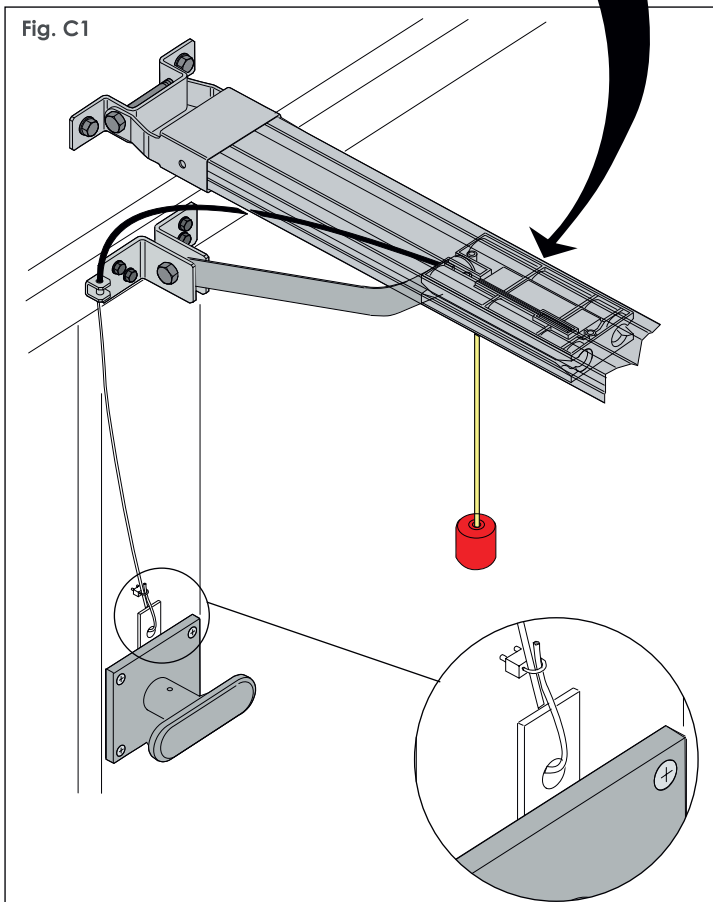
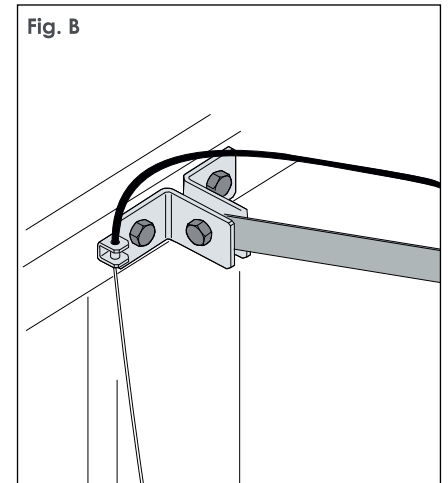
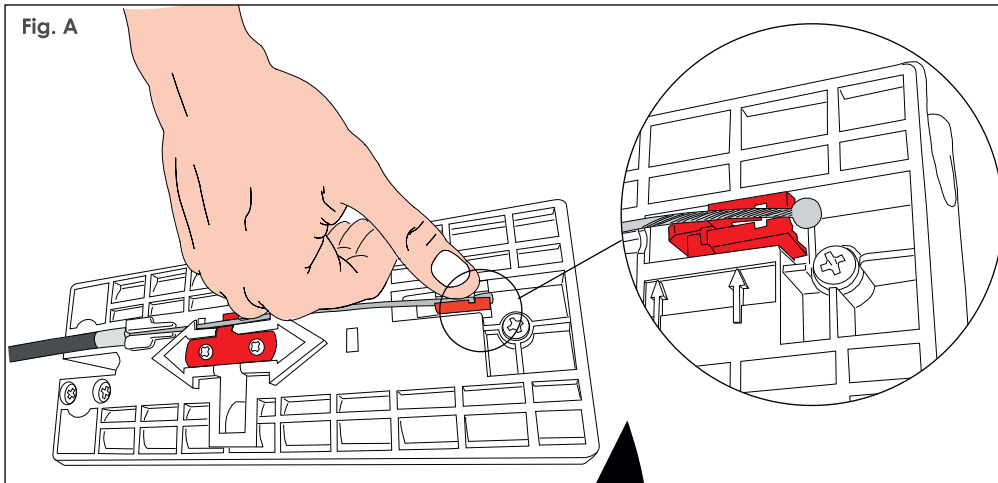

END USER GUIDE

MAINTENANCE

- LIBRA** and **LIBRA Plus** garage door openers are environment friendly products and they generally require minimum maintenance care for normal use.
- Before using the garage door opener make sure that the driving system slides fluently (release the trolley clutch and then open and close the door manually).
- Check regularly the correct open and closed position of the door and make sure that springs can correctly lift up the door. Periodically lubricate all moving mechanical parts.

EMERGENCY RELEASE

In case of power failure, the door will act as follows:

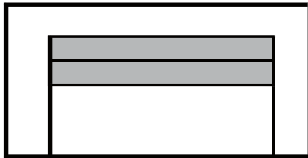

When the power fails, the doors stops.

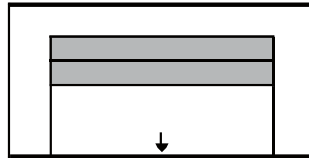

When the power recovers, give an opening impulse with the radio transmitter: the door closes

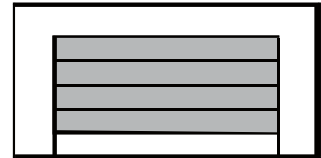

The door reach the closed position, as previously set, and stops still.

In case of power failure, the door can be opened or closed manually after releasing the trolley clutch (see page 5)

TROUBLESHOOTING

Problem	Probable Cause	Possible Solution
The garage door opener doesn't work	<ul style="list-style-type: none"> Power is not properly plugged The fuse is blown 	<ul style="list-style-type: none"> Call for a professional installera Ask a professional to replace the fuse
The door doesn't move	<ul style="list-style-type: none"> No radio transmitter code Radio transmitter battery is flat 	<ul style="list-style-type: none"> Code the radio transmitter again Replace the radio transmitter battery
Radio transmitter range is too short	The radio transmitter battery is not powerful enough	Replace with a new one of the same model
The chain slides, but the door doesn't move	The trolley clutch may not be properly engaged	Engage the trolley clutch (page 5)
The alert keeps sounding	<ul style="list-style-type: none"> The door is open since too long The opener has reached 2000 cycles 	<ul style="list-style-type: none"> Close the door Cut the power off and then power the garage door opener again
The door doesn't open or close properly	Error in commissioning procedure	Perform the commissioning procedure again. (page 7)
The door doesn't work properly and the display shows "H"	Problem of dampness in the control unit	Dry the control unit (by a professional)
The door suddenly stops or bounces and the display shows "F"	<ul style="list-style-type: none"> The pulling spring is distorted The door finds some obstacle The main power is not stable 	<ul style="list-style-type: none"> Ask a professional to repair the spring Remove the obstacle or adjust the obstacle detection settings till the "F" disappear from the display
When the garage door opener is working a grating sound can be heard	Lack of lubricant between the rail and the trolley clutch	Add a suitable quantity of lubricant between the rail and the trolley clutch
Chain has come loose and noisy	Looseness of the chain because it has been used for long time without suitable lubricant	Properly fasten the bolt on the spring, put the chain in the correct position and lubricate it. (page 2)



Electro-shock danger!

Only professionals are allowed to touch the wires and the control unit parts.