

# CARTE EXTENSION 2 PORTES EXTENTION BOARD AND 2 DOORS

Ref : 12-0109

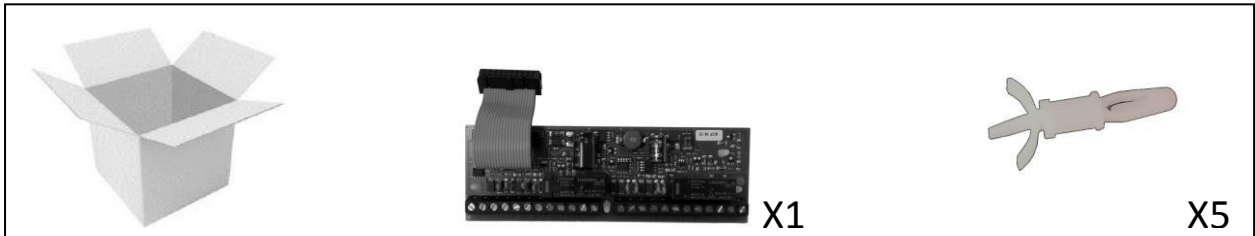

Ref :03-0101

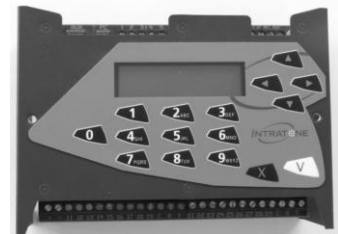

CE  
R&TTE 1999/5/CE  
EN 301 489-3 (2002)  
EN 300 220-3 (2001)

**FRANÇAIS** ATTENTION! Toujours couper l'alimentation au panneau principal avant de procéder à l'installation.

**ENGLISH** Warning! Shut the power supply off before the installation.

**SUOMI** TÄRKEÄÄ! Katkaise aina virta pääkatkaisimesta ennen asennuksen aloittamista.

**ESPAÑOL** ¡IMPORTANTE! Desconecta siempre el interruptor general de electricidad antes de empezar la instalación.

**NEDERLANDS** BELANGRIJK! Schakel de stroom altijd uit voordat met de installatie wordt begonnen.

**DEUTSCH** WICHTIG! Vor der Installation den Strom abschalten.

**DANSK** VIGTIGT! Sluk altid for strømmen, før installationen påbegyndes.





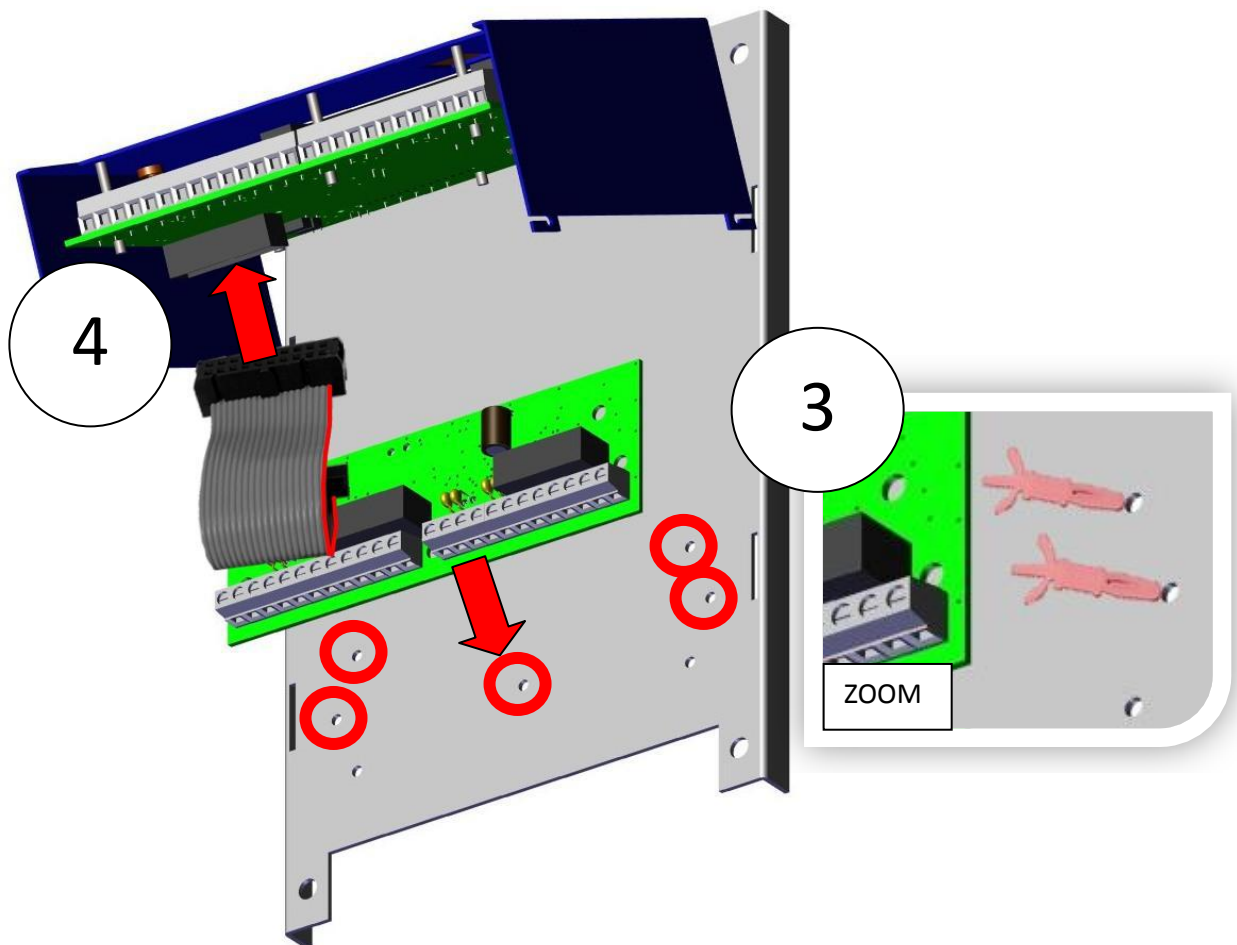
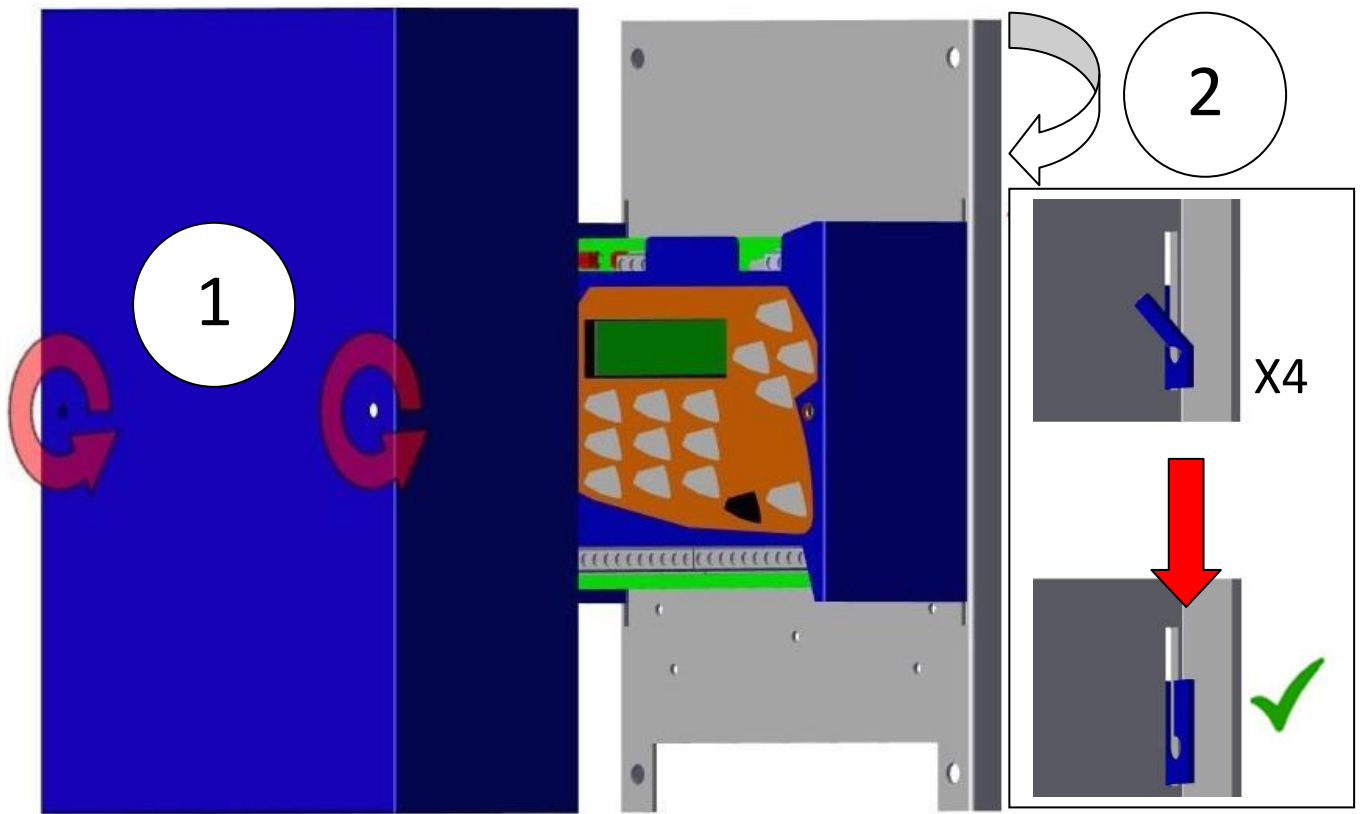

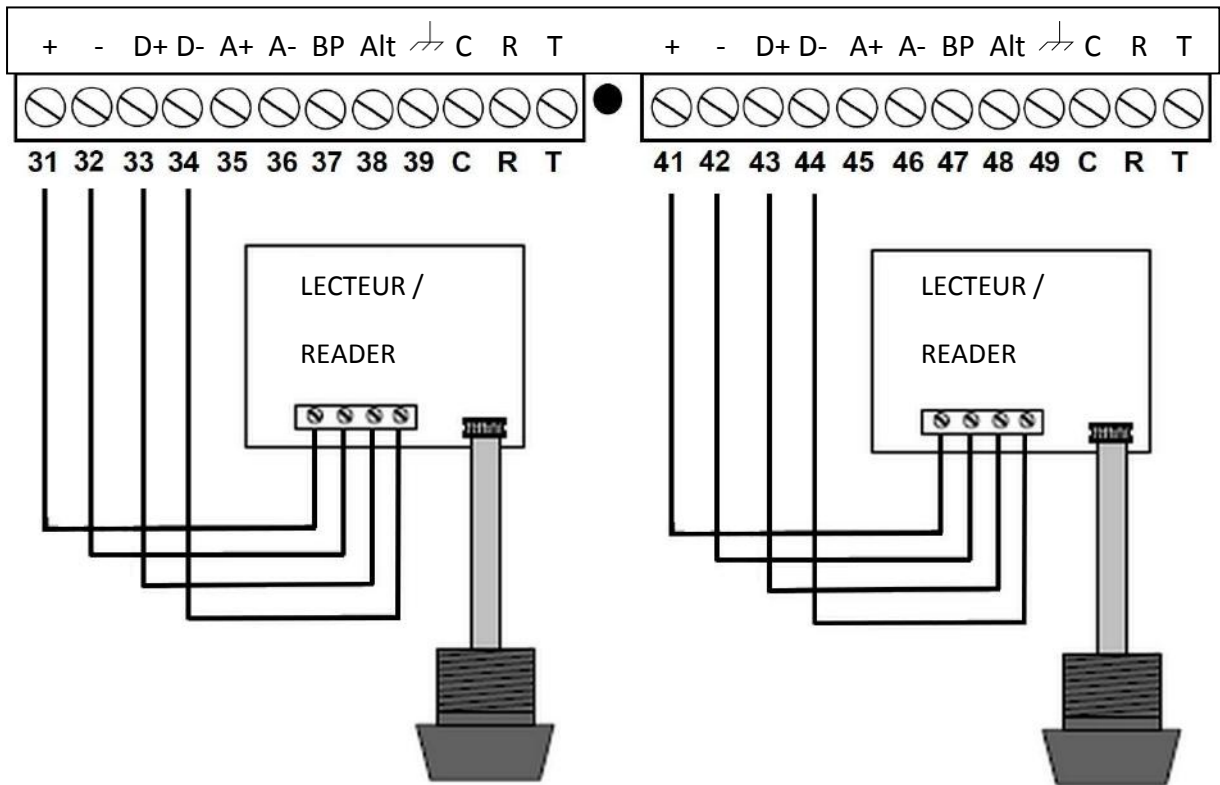
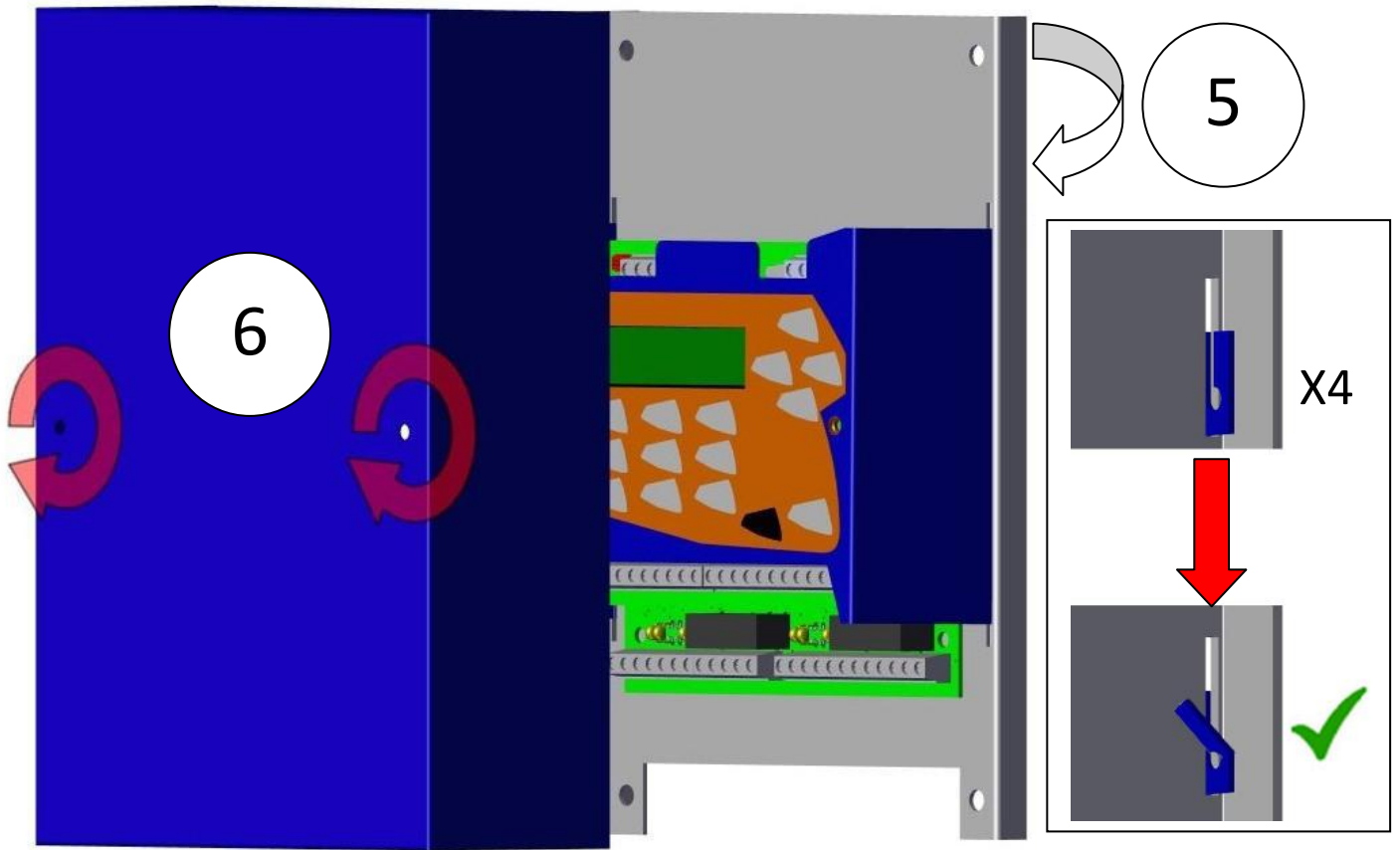



























**NORSK** VIKTIG! Elektriske installasjoner skal utføres av elektriker.

**SVENSKA** VIKTIGT! Stäng alltid av strømmen innan installation påbörjas.





# http://www.intratone.info

 <b>Centrales</b>	<table border="1"><thead><tr><th>Nom</th><th>Série</th><th>Téléphone</th><th>Type</th></tr></thead><tbody><tr><td>Test</td><td>00020001</td><td></td><td></td></tr></tbody></table>	Nom	Série	Téléphone	Type	Test	00020001			→	Carte Extension (HCEXG)	<b>Oui</b> <input checked="" type="radio"/> Non <input type="radio"/>
Nom	Série	Téléphone	Type									
Test	00020001											
 <b>Central units</b>	<table border="1"><thead><tr><th>Name</th><th>Serial</th><th>Phone</th><th>type</th></tr></thead><tbody><tr><td>Test</td><td>00020001</td><td></td><td></td></tr></tbody></table>	Name	Serial	Phone	type	Test	00020001			→	Extension card (HCEXG)	<b>Yes</b> <input type="radio"/> No <input type="radio"/>
Name	Serial	Phone	type									
Test	00020001											
 <b>Zentralen</b>	<table border="1"><thead><tr><th>Name</th><th>Serie</th><th>Telefon</th><th>Typ</th></tr></thead><tbody><tr><td>Test</td><td>00020001</td><td></td><td></td></tr></tbody></table>	Name	Serie	Telefon	Typ	Test	00020001			→	Steckkarte (HCEXG)	<b>Ja</b> <input type="radio"/> Nein <input type="radio"/>
Name	Serie	Telefon	Typ									
Test	00020001											
 <b>Centrales</b>	<table border="1"><thead><tr><th>Naam</th><th>Serie</th><th>Telefoonnummer</th><th>type</th></tr></thead><tbody><tr><td>Test</td><td>00020001</td><td></td><td></td></tr></tbody></table>	Naam	Serie	Telefoonnummer	type	Test	00020001			→	Uitbreidingskaart (HCEXG)	<b>Ja</b> <input checked="" type="radio"/> Nee <input type="radio"/>
Naam	Serie	Telefoonnummer	type									
Test	00020001											
 <b>Keskukset</b>	<table border="1"><thead><tr><th>Huoneistotunnus</th><th>Sarja</th><th>Puhelin</th><th>tyyppi</th></tr></thead><tbody><tr><td>Test</td><td>00020001</td><td></td><td></td></tr></tbody></table>	Huoneistotunnus	Sarja	Puhelin	tyyppi	Test	00020001			→	Laajennuskortti (HCEXG)	<b>Kyllä</b> <input type="radio"/> Ei <input type="radio"/>
Huoneistotunnus	Sarja	Puhelin	tyyppi									
Test	00020001											
 <b>Sentralenheter</b>	<table border="1"><thead><tr><th>Etternavn</th><th>Serie</th><th>Telefon</th><th>Type</th></tr></thead><tbody><tr><td>Test</td><td>00020001</td><td></td><td></td></tr></tbody></table>	Etternavn	Serie	Telefon	Type	Test	00020001			→	Utvidelseskort (HCEXG)	<b>Ja</b> <input type="radio"/> Nei <input type="radio"/>
Etternavn	Serie	Telefon	Type									
Test	00020001											
 <b>Centralenheter</b>	<table border="1"><thead><tr><th>Efternamn</th><th>Serie</th><th>Telefon</th><th>typ</th></tr></thead><tbody><tr><td>Test</td><td>00020001</td><td></td><td></td></tr></tbody></table>	Efternamn	Serie	Telefon	typ	Test	00020001			→	Expansionskort (HCEXG)	<b>Ja</b> <input type="radio"/> Nej <input type="radio"/>
Efternamn	Serie	Telefon	typ									
Test	00020001											
 <b>Centralenheder</b>	<table border="1"><thead><tr><th>Efternavn</th><th>Serie</th><th>Telefon</th><th>Type</th></tr></thead><tbody><tr><td>Test</td><td>00020001</td><td></td><td></td></tr></tbody></table>	Efternavn	Serie	Telefon	Type	Test	00020001			→	Udvidelseskort (HCEXG)	<b>Ja</b> <input type="radio"/> Nej <input type="radio"/>
Efternavn	Serie	Telefon	Type									
Test	00020001											
 <b>Centrales</b>	<table border="1"><thead><tr><th>Apellido</th><th>Serie</th><th>Teléfono</th><th>tipo</th></tr></thead><tbody><tr><td>Test</td><td>00020001</td><td></td><td></td></tr></tbody></table>	Apellido	Serie	Teléfono	tipo	Test	00020001			→	Tarjeta Extensión (HCEXG)	<b>Si</b> <input type="radio"/> No <input type="radio"/>
Apellido	Serie	Teléfono	tipo									
Test	00020001		