

MotionProtect Outdoor User Manual

Updated June 24, 2020



MotionProtect Outdoor is a wireless outdoor motion detector for the Ajax security system. The detector communicates with the hub via protected [Jeweller](#) radio protocol at a distance up to 1,700 meters in the line of sight. MotionProtect Outdoor features protection against blocking the detector view (anti-masking system) and triggering by pets (pet immunity). The motion detection distance is adjustable: from 3 up to 15 meters.

MotionProtect Outdoor can operate both on pre-installed batteries or use an external power supply. Depending on the detector settings, the batteries' life is up to 5 years.



MotionProtect Outdoor does not support connection via the [ocBridge Plus](#) and [uartBridge](#) integration modules.

The user can configure the detector via the [Ajax app](#) for iOS, Android, macOS, and Windows. The security system notifies users of all events through push notifications, SMS, and calls (if activated).

The Ajax security system can be connected to a central monitoring station of a security company.

Buy outdoor motion detector MotionProtect Outdoor

Functional Elements

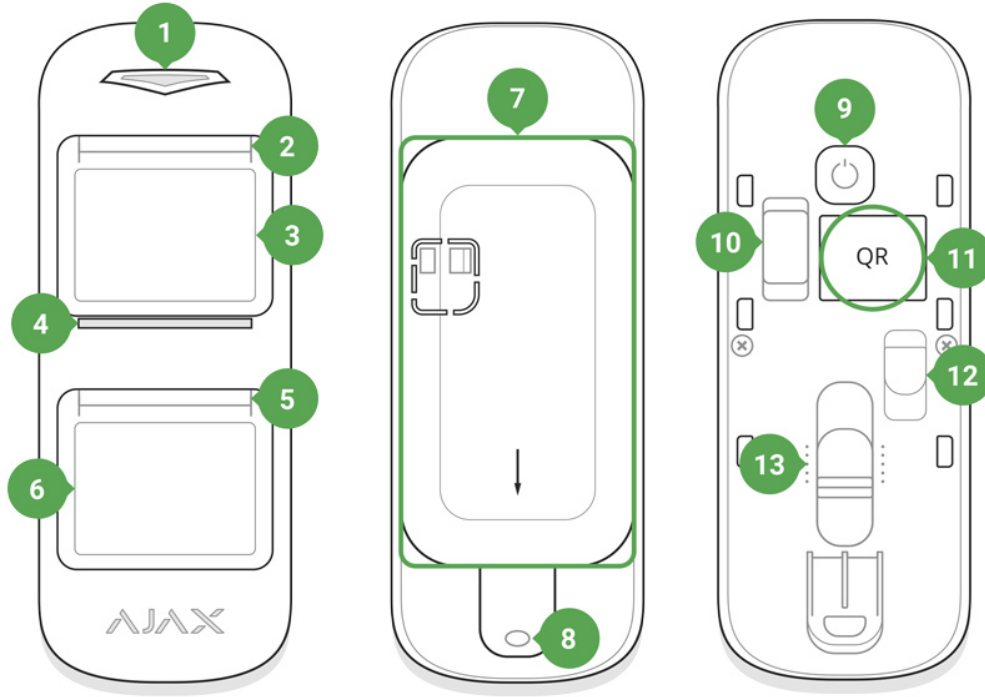

1. Main light indicator
2. Upper light indicator and masking sensor
3. Upper motion sensor lens
4. Masking sensor
5. Lower light indicator and masking sensor
6. Lower motion sensor lens
7. SmartBracket attachment panel (perforated part is required for actuating the tamper button in case of any attempt to dismantle the detector)
8. The hole for attaching SmartBracket panel with a screw
9. "On" button
10. Tamper button
11. QR Code

12. Connector for external power supply cable outlet

13. Scrollbar for adjusting the motion detection range

Operating Principle

When the system is armed, the detector continuously receives signals from two PIR sensors. If both sensors detect identical motion, MotionProtect Outdoor instantly transmits an alarm signal to the hub and blinks with a green LED. MotionProtect Outdoor ignores animals, birds, insects, as well as swaying plants and trees.



By a motion alarm, the security system also can activate sirens and notify a security company if connected.

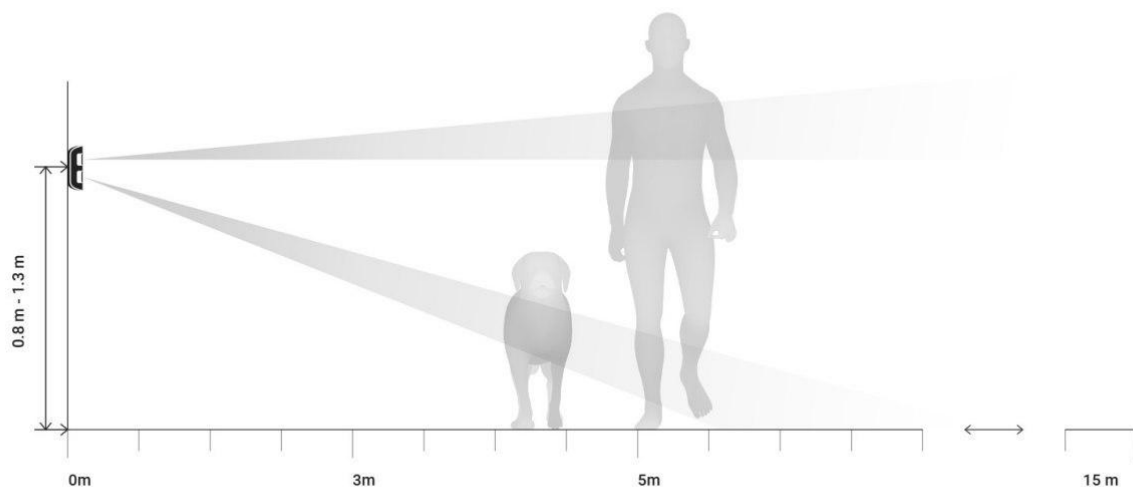

The detector recognizes motion and sends the first alarm immediately, but next alarms until disarming are transmitted no more than once in 5 seconds.

If a motion is detected before the system is armed, the detector will be armed not immediately, but during the next polling by the hub.

[Learn more about the algorithm of the detector operation](#)

Anti-masking system

Masking is an attempt to block in any way the view of the detector's lens.

MotionProtect Outdoor detects the following types of masking:

- An obstacle in front of both lenses (an object on the height of the detector and at a distance of up to 20 cm in front of it)
- An obstacle in front of any of the lenses (an object at a distance of up to 10 cm in front of one of the lenses)
- Painting or pasting any of the lenses with an opaque substance
- Pasting the detector front side with an opaque substance
- Applying an aerosol or painting the detector front side with lacquer/paint

If one or more types of masking are detected, the detector generates a masking alarm and lights up a green LED for 1 second.

MotionProtect Outdoor detects masking regardless of the security state: armed or disarmed.

Response time to masking

Masking type	Active mode (detector is armed)		Passive mode (detector is disarmed)	
	Time to alarm, s	Time to restore, s	Time to alarm, s	Time to restore, s
An obstacle in front of both lenses	2	5,4	300	18
An obstacle in front of any of the lenses	150	13	150	5,4
Pasting or painting any of the lenses	150	13	150	5,4
Pasting the detector front side	150	9	300	18

Applying aerosol or painting the detector front side with lacquer/paint	150	9	150	9
---	-----	---	-----	---

Connecting

Before starting connection:

1. Following the hub user guide, install the [Ajax app](#). Create the account, add the hub, and create at least one room.
2. Switch on the hub and check the internet connection (via Ethernet cable and/or GSM network).
3. Make sure that the hub is disarmed and does not update by checking its status in the Ajax app.



Only users with administrator rights can add the device to the hub

How to connect the device to the hub:

1. Select the **Add Device** option in the Ajax application.
2. Name the device, scan/write manually the **QR Code** (located on the body and packaging), and select the location room.

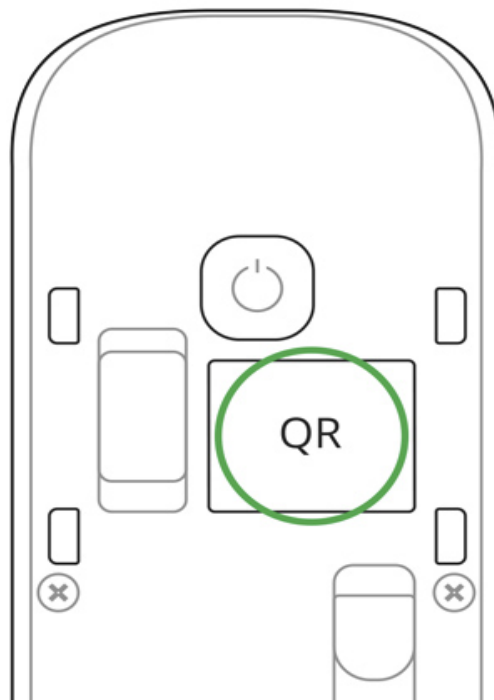

3. Select **Add** – the countdown will begin.

4. Switch on the device by pressing the on/off button for 3 seconds.

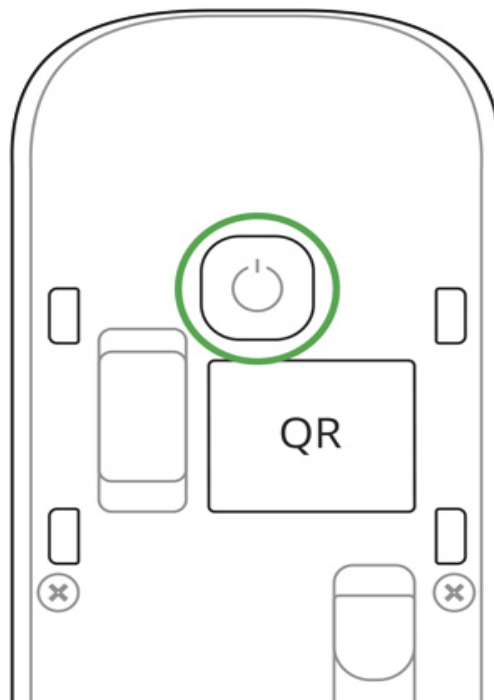

For the detection and interfacing to occur, the detector should be located within the coverage area of the wireless network of the hub (at a single protected object). Request for connection to the hub is transmitted for a short time at the time of switching on the device.

MotionProtect Outdoor turns off automatically after 6 seconds, if it failed to connect to the hub. To retry the connection, you do not need to switch off the device. If the detector has already been assigned to another hub, turn off MotionProtect Outdoor, and then follow the standard addition procedure.

If the connection to the hub failed, repeat the connection attempt after 30 seconds.

The device connected to the hub will appear in the list of devices of the hub in the app. The update of the detector statuses in the list depends on the device ping interval set in the hub settings (the default value is 36 seconds).











To avoid masking alarms, switch off anti-masking in the device settings before the installation!









States

1. Devices
2. MotionProtect Outdoor

[← Back](#) MotionProtect Outdoor



 Temperature	-23 °C
 Jeweller Signal Strength	
 Battery Charge	OK
 Lid	Closed
 Delay When Entering, sec	Disabled
 Delay When Leaving, sec	Disabled
 Routed Through ReX	No

 Lid	Closed
 Delay When Entering, sec	Disabled
 Delay When Leaving, sec	Disabled
 Routed Through ReX	No
 External Power	Disconnected
 Connection	Online
 Sensitivity	Normal
 Anti-masking	ON
 Always Active	No

Ajax MotionProtect Outdoor
Firmware 3.55.0.0, Device ID 136B2A131

Parameter	Value
Temperature	Temperature of the Detector. Measured on the processor and changes gradually
Jeweller Signal Strength	Signal strength between the hub and the detector
Connection	Connection status between the hub and the detector
Battery Charge	Battery level of the detector, displayed in increments of 25%
Lid	The tamper mode of the detector, which reacts to the detachment of or damage to the body
Delay when entering, sec	Delay time when entering
Delay when leaving, sec	Delay period after the security system is armed
Routed Through ReX	Displays the status of using the ReX range extender
External Power	Displays the status of using the external power supply
Sensitivity	Sensitivity level of the motion detector: low, normal, high
Anti-masking	Has the anti-masking option been enabled
Always Active	When turned on, the motion detector always detects movement
Firmware	Detector firmware version

Device ID

Device identifier

Settings

- 1. Devices
- 2. MotionProtect Outdoor
- 3. Settings 

[Back](#) MotionProtect Outdoor..



MotionProtect Outdoor 



Room: office 

Sensitivity: Normal 

Anti-masking

Always Active:

 Delay When Entering, sec 0 

 Delay When Leaving, sec 0 

Arm in Night Mode

ALERT WITH A SIREN



If motion detected



If masking detected

 Jeweller Signal Strength Test

 Detection Zone Test

[Back](#) MotionProtect Outdoor..

 Delay When Entering, sec 0 

 Delay When Leaving, sec 0 

Arm in Night Mode

ALERT WITH A SIREN

If motion detected

If masking detected

 Jeweller Signal Strength Test

 Detection Zone Test

 Attenuation Test

 User Guide

Setting	Value
First field	Detector name, can be edited
Room	Selecting the virtual room to which the device is assigned
Delay when entering, sec	Selecting delay time when entering
Delay when leaving, sec	Delay period after the security system is armed
Delays in night mode	When enabled, the detector will experience a delay in the night mode
Arm in night mode	When turned on, the detector will switch to armed mode when using night mode
Sensitivity	<p>Choosing the sensitivity level of the motion sensor:</p> <ul style="list-style-type: none"> • High • Normal • Low
Anti-masking	If active, sensor will always detect masking
Always active	When turned on, the detector always registers motion
Alert with a siren if motion detected	If active, HomeSiren and StreetSiren are activated when the motion detected
Jeweller Signal Strength Test	Switches the detector to the Jeweller signal strength test mode
Detection Zone Test	<p>Switches the detector to the detection area test:</p> <ul style="list-style-type: none"> • General motion detector test • Upper motion detector test • Lower motion detector test • Masking sensor test (if anti-masking function is enabled)
Attenuation test	Switches the detector to the signal fade test

	mode (available in detectors with firmware version 3.50 and later)
User Guide	Opens the detector User Guide
Unpair Device	Disconnects the detector from the hub and deletes its settings

Indication

MotionProtect Outdoor light indicator may light up red or green depending on the device status.

Indication When Pressing the “On” button

Event	Indication
Pressing the power button (detector is switched on)	Lights up red while the button is held down
Switching on	Lights up green while the device is switching on
Switching off	Initially lights up red, then blinks three times

Turned-on detector indication

Event	Indication	Note
Detector connection to the hub	Lights up green for a few seconds	
Hardware error	Blinks red continuously	The detector requires repair, please contact Support Service
Motion- and masking-triggered alarm or tamper button triggering	Lights up green for about one second	
Battery needs replacing	During the alarm, it slowly lights up green and slowly goes out	Replacement of the detector battery is described in the Battery replacement manual

Functionality Testing

The Ajax security system allows conducting tests for checking the functionality of connected devices.

The tests do not start immediately but within a period of 36 seconds when using default settings. The test time start depends on the settings of the detector ping interval (the “**Jeweller**” menu in the hub settings).

Jeweller Signal Strength Test

Detection Zone Test

Attenuation test

According to the requirements of EN50131, the level of the radio signal sent by wireless devices is reduced during the test mode.

Choosing an installation place



Before installing the detector, conduct the Jeweller signal strength test.

Install MotionProtect Outdoor at the height of 0.8 – 1.3 m, ensuring the upper lens axis to be parallel to the ground, and the supposed intrusion path is perpendicular to the lens axis.

When choosing the installation place, consider the maximum device detection range. It depends on the sensitivity level and the position of the regulator for adjusting the motion detection range.

Regulator position	Sensitivity level	Motion detection range
Top (minimum range)	Low / Middle / High	up to 3 meters
Middle (middle range)	Low	up to 7 meters
	Middle / High	up to 8 meters

Low (maximum range)	Low / Middle / High	up to 15 meters
------------------------	---------------------	-----------------

The detection range was tested at an ambient temperature of +23°C and clear weather. In other conditions, the detection range may vary. When choosing an installation place, use the [Detection Zone Test](#) to determine the sector in which the device detects movement as accurately as possible.

To avoid false alarms due to rain or snow falling on the masking sensors, install MotionProtect Outdoor under a covering. To protect masking sensors in the open area, use [Hood for MotionProtect Outdoor cover](#).

MotionProtect Outdoor sends an alarm to the hub only if both PIR sensors detect identical motion. The difference in time of motion detection should not exceed 1.5 seconds.

Check the detector functioning at the alleged installation place. When choosing the location of MotionProtect Outdoor, take into account the radio signal communication range.

If the signal level is low (one bar), we cannot guarantee the stable operation of the detector. Take all possible measures to improve the quality of the signal. At least, move the detector: even a 20 cm shift can significantly improve the quality of signal reception.

If the detector has low or unstable signal strength even after moving, use a [ReX radio signal range extender](#).



Be careful when mounting the attachment panel. Excessive force during its mounting can lead to deformation of the panel and, consequently, to the inability to install the detector or to its unreliable fixation. Attach SmartBracket with the bundled fixing tools. Using any other tools, e.g., large diameter screws may damage the attachment panel. We do not recommend using double-sided adhesive tape for permanent mounting. The tape runs dry with time, which can cause falling, false triggering, and detector malfunction.

Do not install the detector:

- Without Hood for MotionProtect Outdoor in a place without a covering.

- Opposite the trees whose leaves can be in the detection zone of the upper and lower PIR sensors of the detector.
- Opposite the bushes higher than 80 cm.
- Near metal objects and mirrors (they can shield the radio signal and lead to its attenuation).
- Closer than 1 meter from the hub.

Note that MotionProtect Outdoor does not detect movement behind the glass. Therefore, do not install the detector in locations where glass objects can obstruct the detector's view. For example, in places where a glass door can obstruct the view of the device.

Install detector at a height 0.8 to 1.3 meters so that its upper lens looks parallel to the ground. If the site is uneven, the installation height is considered from the highest point of the territory controlled by the detector.

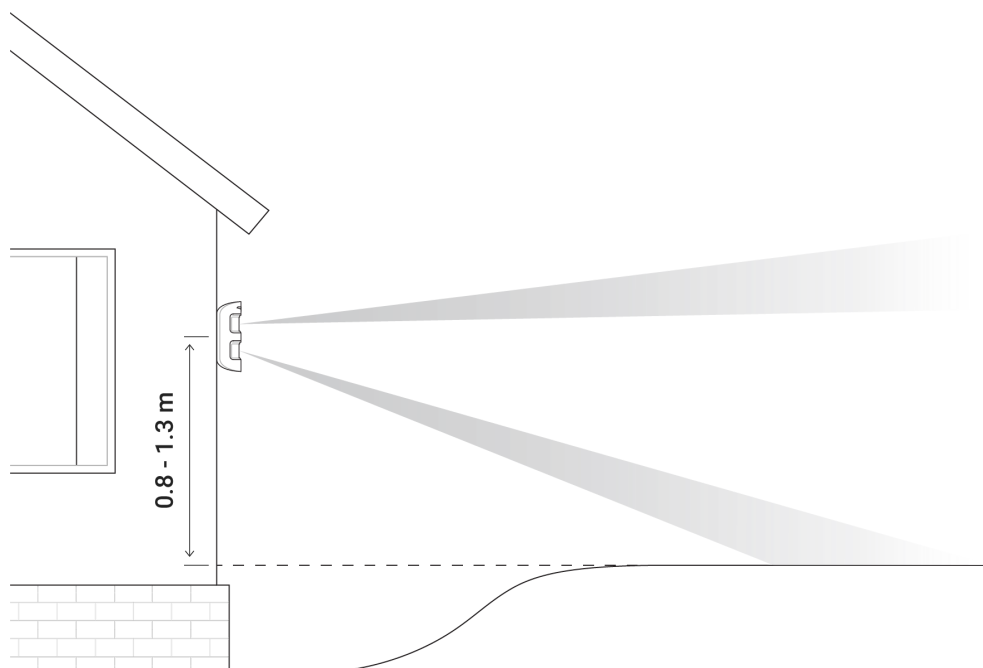

Detector installation procedure

1. Fix the SmartBracket attachment panel on the surface temporarily using bundled screws or double-sided adhesive tape. Consider the installation height: 0.8 – 1.3 meters.

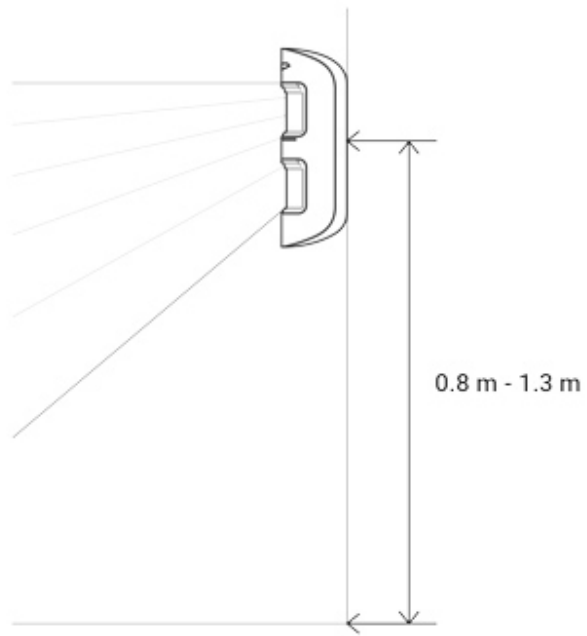

2. Select the motion detection distance (3 to 15 m) using the adjustment scroll bar.

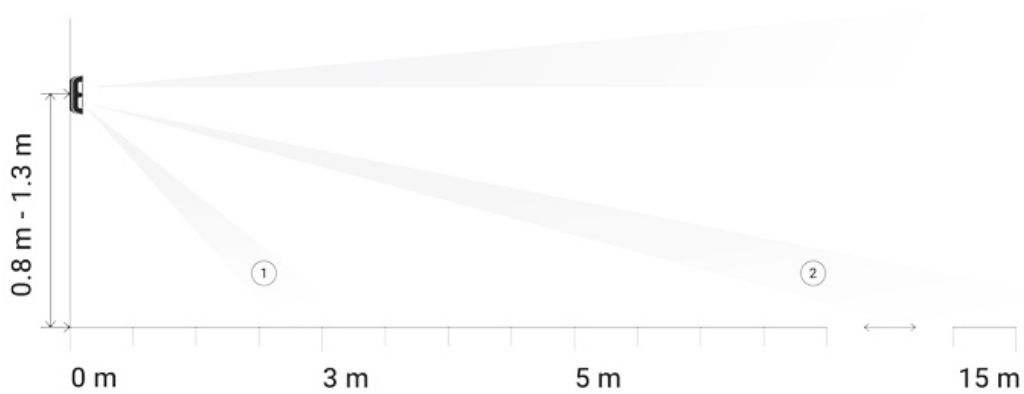
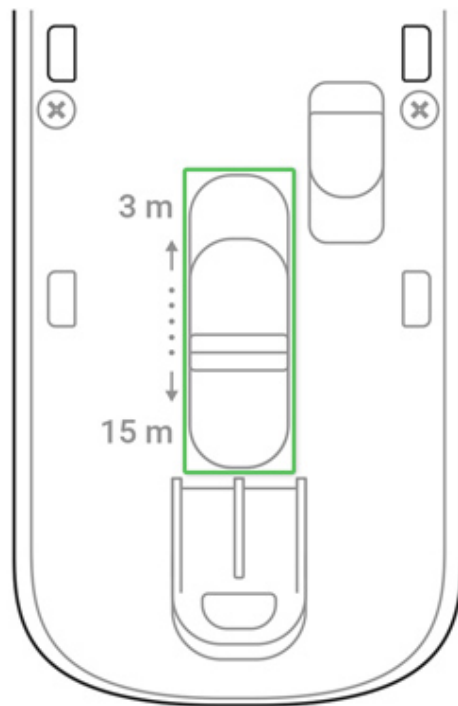

The lower PIR sensor beam direction with the specified minimum (1) and maximum (2) detection range

- Put MotionProtect Outdoor on the SmartBracket attachment panel. Leave the detection area (horizontal detection angle – 90°) and make sure that there are no moving objects within the detection area to calibrate anti-masking sensors properly.

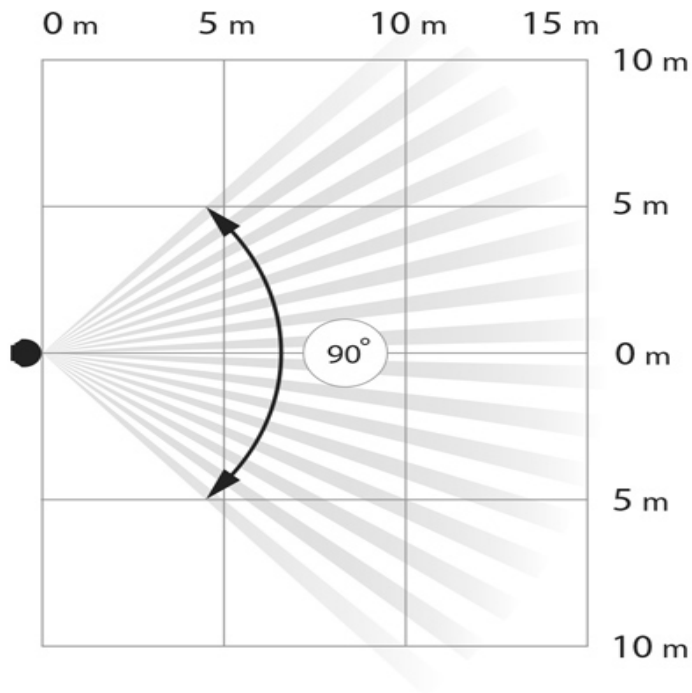

Attention! The anti-masking sensors will begin to calibrate automatically when the detector has been put on the SmartBracket attachment panel. Calibration lasts up to 30 seconds and is followed by the flashing upper and lower LED indicators.

- Conduct the Detection Zone Test for upper and lower sensors separately, both sensors simultaneously, and anti-masking test in the [Ajax app](#). If the detector does not react to motion, select the appropriate sensitivity level, detection range, and check the detector slope angle.
- If all tests have been appropriately passed, fix the SmartBracket to the surface with screws permanently, put MotionProtect Outdoor on the attachment panel, and wait until the end of calibration. Fix the detector on the attachment panel with the bundled screw.

Connecting External Power Supply

MotionProtect Outdoor can use external power supply 5-28 V DC, 200 mA. If the external power supply is connected, there is no need to remove the pre-installed batteries. Batteries provide the detector with the backup power source.

To connect the external power supply:

1. Disassemble the detector body: remove the screws and open the lid.
2. Break off special caps on the SmartBracket attachment panel:

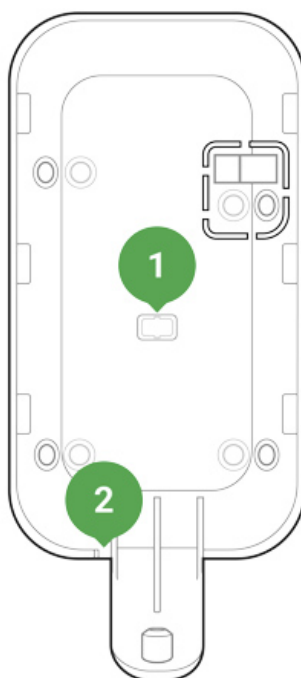

1. A cap for putting out the power supply wire behind the SmartBracket attachment panel
2. A cap for putting out the power supply wire below the SmartBracket attachment panel
3. Run the external power supply dead wire through the attachment panel and cap.
4. Connect the cable to the terminal strips observing polarity. Fix the wire with the clamp.

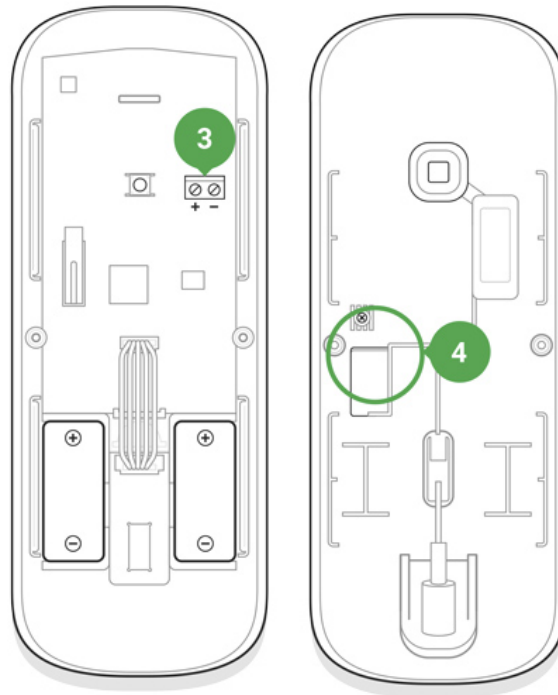

3. Terminal strips on the detector board
4. The clamp on the back of the detector body
5. Switch on the power supply. The value of the **External Power Supply** field in the detector settings will change to **Connected**.



Use grounded power supply source only!

6. Fix the rear of the body with screws, install the detector and wait until the end of calibration.

Maintenance

Check the operational capability of the detector regularly. Clean the detector body from dust, spider web, and other contaminants as they appear. Use soft dry napkin suitable for tech equipment.

Do not use any substances containing alcohol, acetone, gasoline, and other active solvents to clean the detector.

The pre-installed battery ensures up to 5 years of autonomous operation (with the 3 minutes ping interval by the hub). If the detector battery is low, the system notifies the user, and the LED indicator smoothly lights up and goes off if a glass break is detected or the tamper is triggered.

Battery replacement

Hood Installation

Hood for MotionProtect Outdoor is a cover protecting masking sensors of the detector from rain and snow. Install it when the detector cannot be placed under the covering.

Buy Hood for MotionProtect Outdoor



Hood for MotionProtect Outdoor can be mounted even on a detector that is already installed. You don't need to detach the device from the surface for installing the hood.

To install Hood for MotionProtect Outdoor:

1. Remove the protective film from the Dual Lock tape, which is glued to the inner surface of the hood.
2. Attach the hood to the detector – part of the tape will stick to the body of the detector.
3. Detach the hood from the MotionProtect Outdoor and smooth out the part of the tape that remained on the detector body.

4. Put the hood back so that both parts of the tape stuck, fixing the hood on the detector.

Tech Specs

Sensing element	PIR sensor, 2 pcs
Detection angle, horizontal	90°
Motion detection distance	Adjustable, 3–15 m when the detector is installed at 1 m height
Protection against masking	Yes
Pet ignoring function	Yes, height up to 80 cm when the detector is installed at 1 m height <u>Why motion detectors react to animals and how to avoid it ></u>
Protection against false triggering	Yes, algorithmic analysis
Frequency band	868.0 – 868.6 MHz or 868.7 – 869.2 MHz, depending on the sales region
Compatibility	Operates only with <u>Hub</u> , <u>Hub Plus</u> , <u>Hub 2</u> and <u>ReX</u>
Maximum radio signal power	Up to 20 mW
Radio signal modulation	GFSK
Radio signal range	Up to 1,700 m (where there are no obstacles)
Power supply	2 × CR123A, 3 V
Battery life	Up to 5 years
External power	5 – 28 V DC, 200 mA
Usage	Indoors and outdoors
Body protection level	IP55
Anti-tamper switch	Yes
Installation method	Outdoors/indoors
Operating temperature range	From -25°C to +60°C

Operating humidity	Up to 95%
Accessories	Hood for MotionProtect Outdoor
Overall dimensions	183 × 70 × 65 mm
Weight	322 g

Complete set

1. MotionProtect Outdoor
2. SmartBracket mounting panel
3. CR123A battery – 2 pcs. (pre-installed)
4. Installation kit
5. Quick Start Guide

Warranty

Warranty for the “AJAX SYSTEMS MANUFACTURING” LIMITED LIABILITY COMPANY products is valid for 2 years after the purchase and does not apply to the pre-installed battery.

If the device does not work correctly, you should first contact the support service—in half of the cases, technical issues can be solved remotely!