

Installation & User Instructions

CellCOM PRIME Standalone GSM Range

PROFESSIONAL INSTALL ONLY



Suitable for Firmware Version 2.1.2

The manufacturer cannot legally offer technical support to non-qualified gate or door installers. End users should employ the services of a professional install company to commission or support this product!

Tip: Site Survey BEFORE you begin.

See pages 3-4



WARNING

Do not power from the gate controller. Only use the provided UL power supply, otherwise damage may occur and warranty may be void.

Index

Section	Pages
PHASE 1 – SITE SURVEY	3 - 4
Site Survey (LAN)	4
PHASE 2 – PRODUCT OVERVIEW	5 - 20
Overview of Call Points	6 - 10
More Detail....	11 - 15
PCB Module Overview	17 - 18
Technical Specifications	19 - 20
PHASE 3 - SETUP	21 - 26
Preparation Before Configuration	22
Inserting the SIM & Power Connections	23
Status LED's	24
Check Reception	25
Set APN (for VOLTE / 4G service)	26
PHASE 4 - INSTALLATION	27 - 32
How to Achieve & Maintain IP55 Rating	28
Power & Solar Power	29
Inserting the SIM & Power Connections	30
Relay Wiring Examples	31
Connecting Slave Devices	32
PHASE 5 – APP PROGRAMMING	33 -
Installing the Programmer APP for the first time	34 - 35
Check Reception	36
Set APN (for VOLTE / 4G service)	37
Programming Numbers to call	38
Programming Caller ID access numbers	39
Additional Programming Features	40 - 54
PHASE 6 – USING THE INTERCOM	55 - 70
Calling a Resident & Using Keypad Codes & Prox IDs	56
Receiving A Call and Using Caller ID	57
Using the CellCOM Prime App	58 - 70
PHASE 7 – AFTERCARE	70 - 80
Troubleshooting	72 - 74
Firmware Updates	75 - 78
App Updates / Intercom Maintenance /	79
Environmental Information	
Ingress / Documentation Feedback	80
Warranty	83

PHASE 1

Site Survey

Important things you Need to Know..



Please read this entire manual before installing this product.



To be installed by certified and qualified personnel / gate automation dealer only. **Not for DIY install!**



Ensure there is a good 4G signal on site. 4G units will fall back to 3G service in some countries.



Set up, on a bench in the workshop **BEFORE** going to the site. Program the unit in the comfort of your workbench and call technical support should you have questions.



This product requires a regular voice & SMS SIM card. **Do not use a data-only SIM, as this will not work in the unit.**

To make voice calls on a 4G system and get optimum service, your SIM and provider will need to offer VOLTE support (Voice over LTE) otherwise the unit will be forced to fall back to 3G or 2G service to make calls.

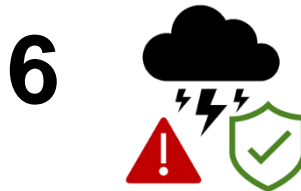

Manufacturer warranty does NOT cover lighting/storm damage. In lightning prone areas, you **MUST** fit external surge protection and the lightning rod to maintain a warranty on this product.

PHASE 2

Product Overview

Overview of Switches

Antenna Integrated



Overview of Intercoms (Architectural Design)

Antenna Separate

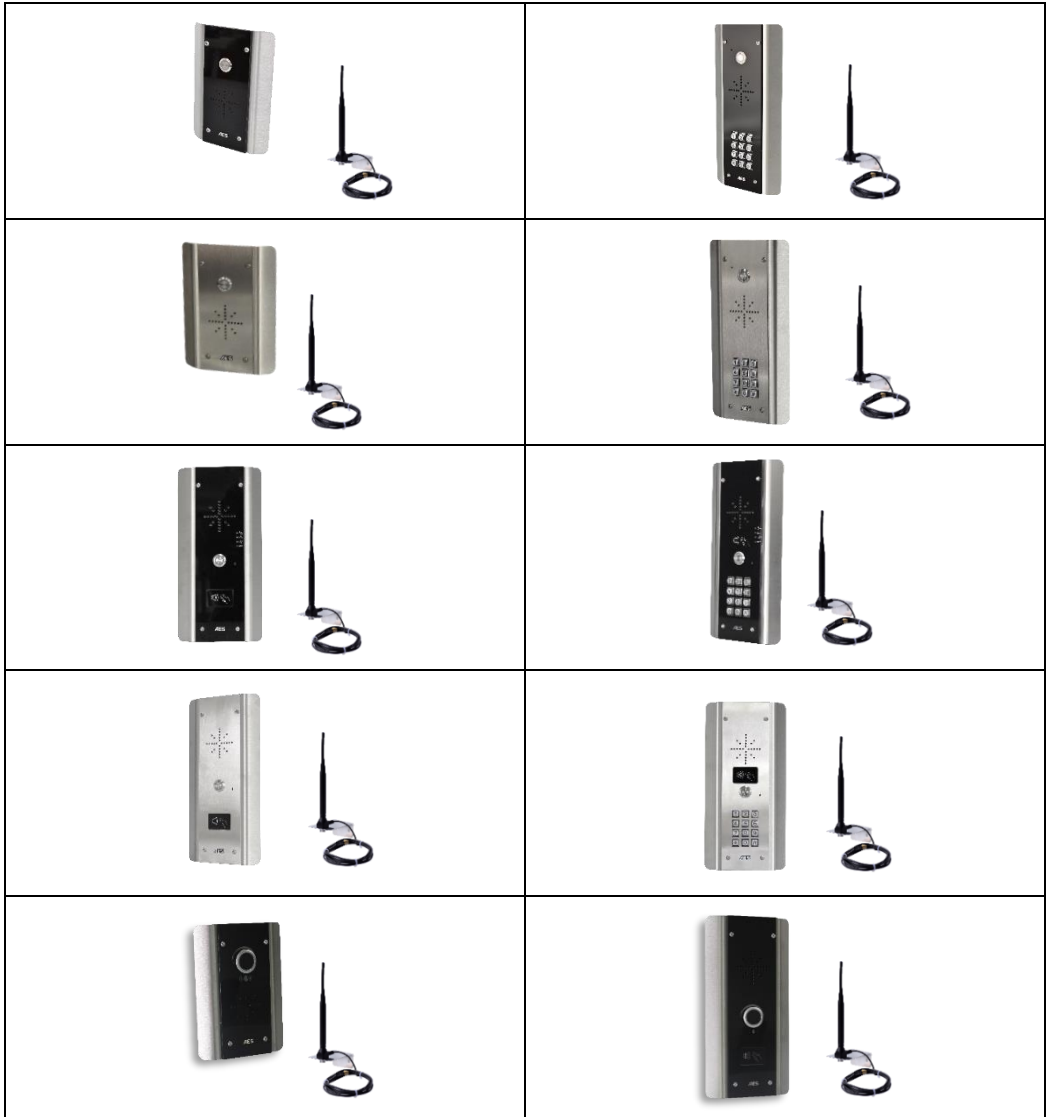

Overview of Intercoms (Imperial Design)

Antenna Separate

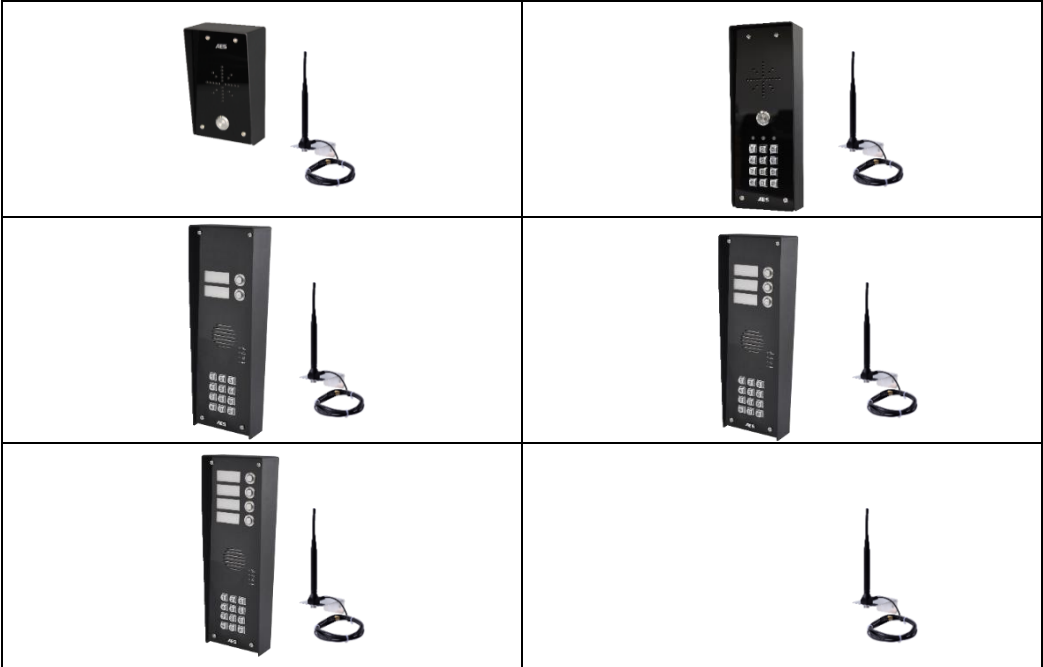

Overview of Intercoms (Pedestal Design)

Antenna Integrated



Overview of Intercoms (Flush Design)

Antenna Integrated

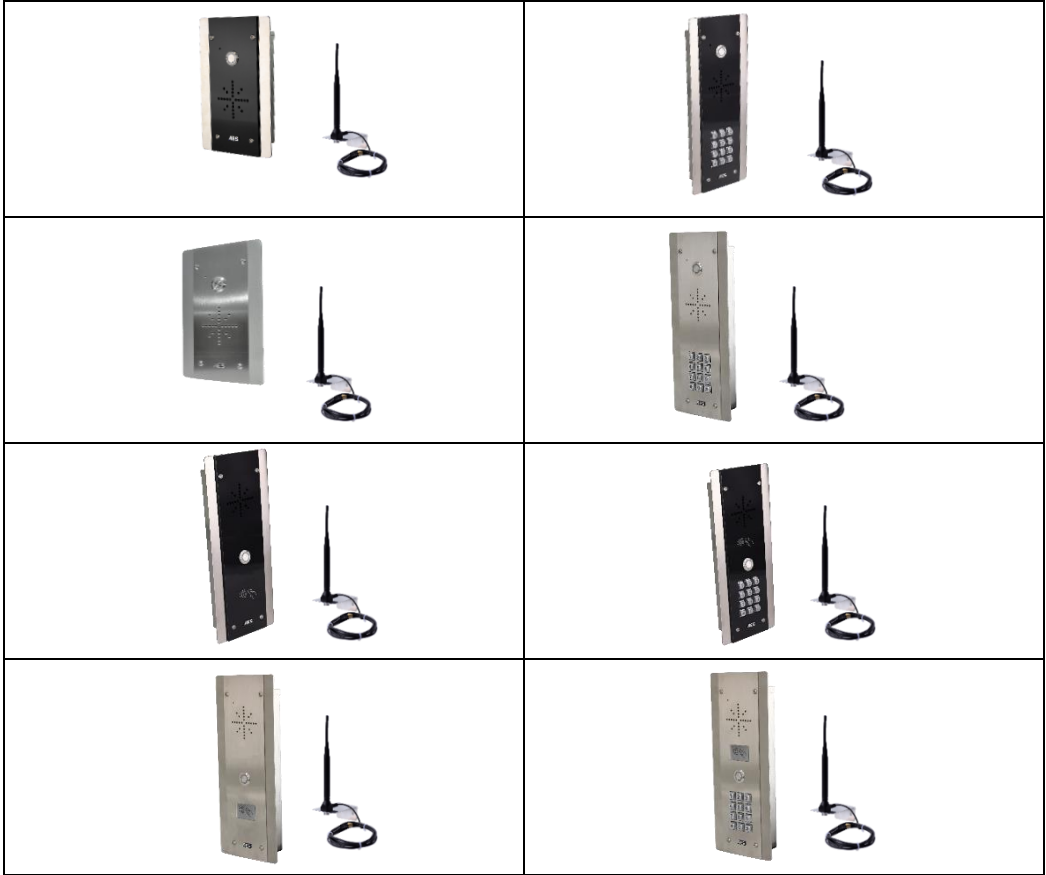

More Detail....

GSM Switch

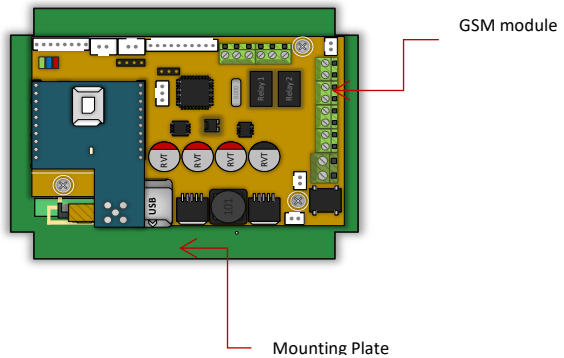

Architectural Model

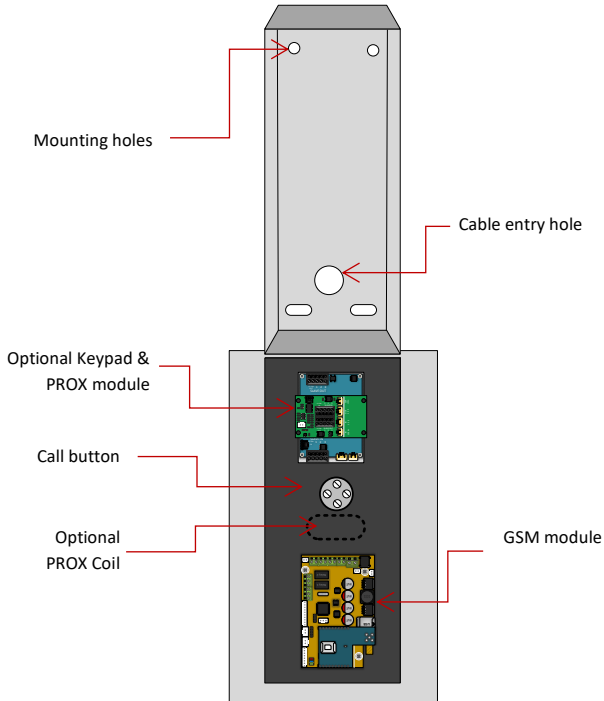

Architectural Model (No Touch)

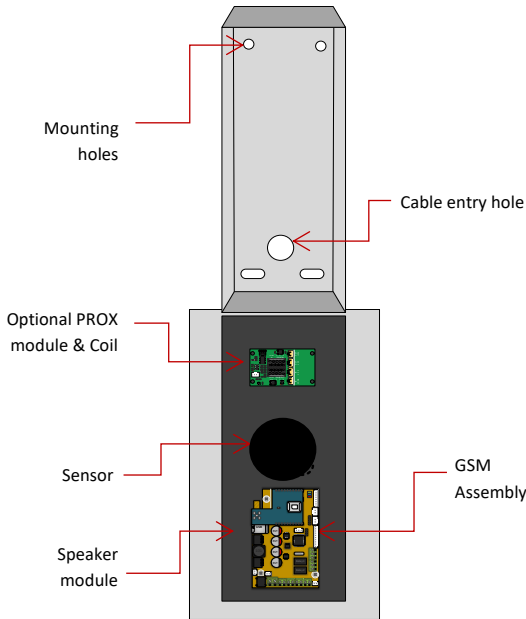

Due to the nature of a contactless sensor in replace of a physical button and if using the panel externally the sensor must be protected from direct rain/snowfall to avoid false triggering of the sensor.

Note: the infrared sensors proximity range is fixed (approx. 14 cm) respectively the no touch sensor can be triggered by anything that passes in front of it for example but not limited to heavy snow, heavy rainfall; bugs cobwebs etc... This can cause false triggering issues if not properly maintained.

There is a 'Do Not Disturb' feature that can be programmed to prevent calls being received at set hours, but this is not a replacement for providing adequate cover for the sensor.

Imperial Version

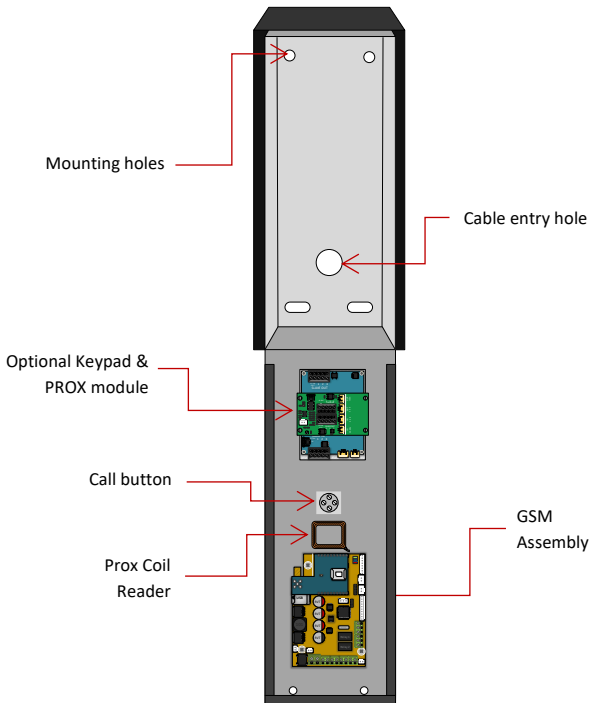

Imperial Version (multi-button)

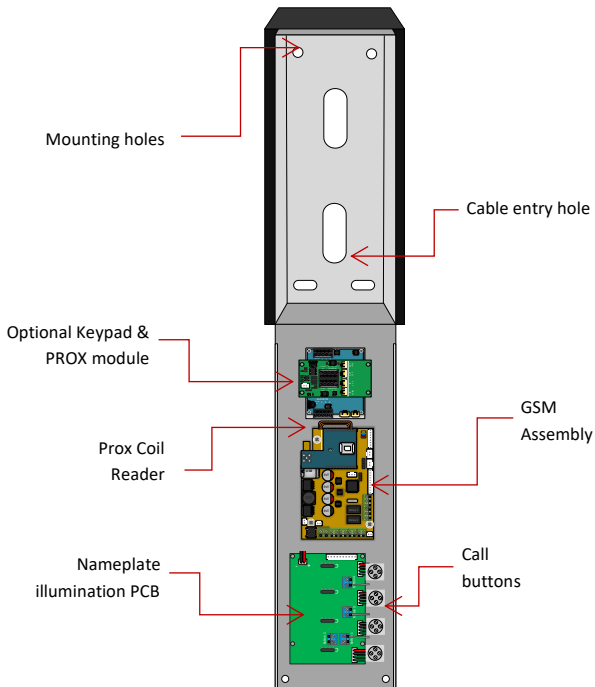

Pedestal Version

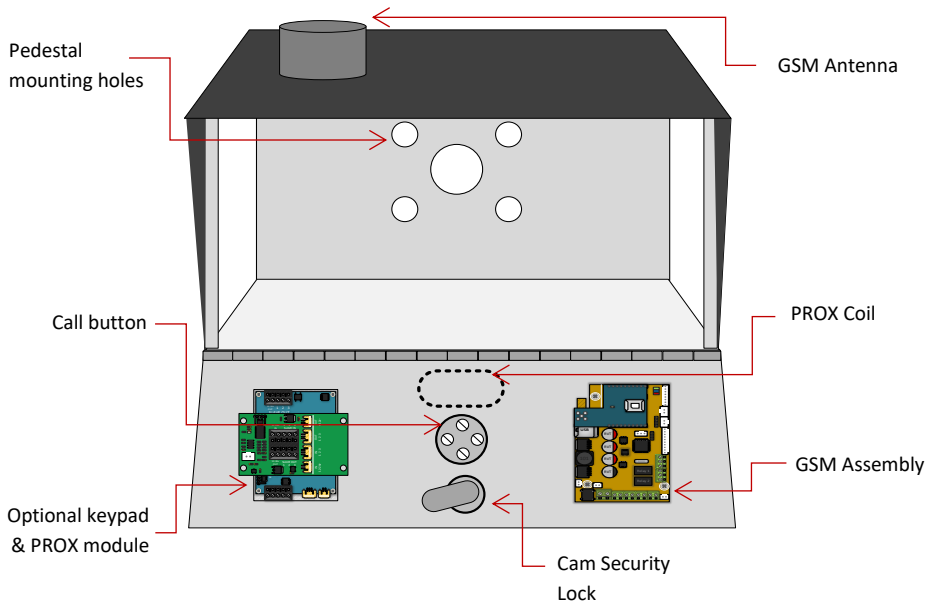

Main GSM Module in Detail...

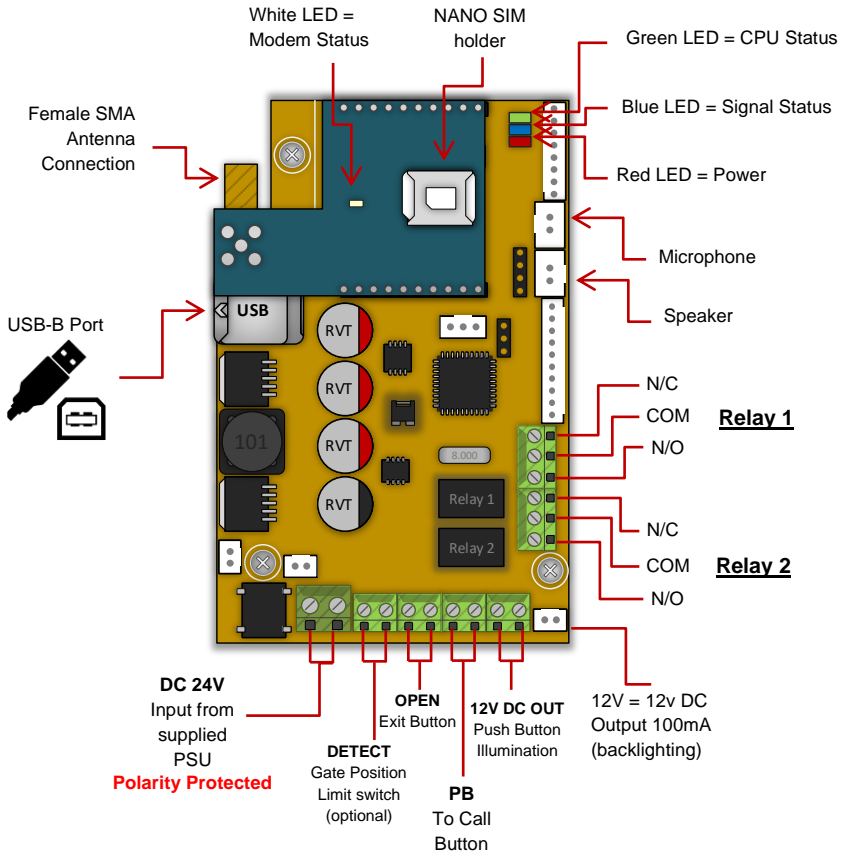

Keypad & PROX Module's in Detail

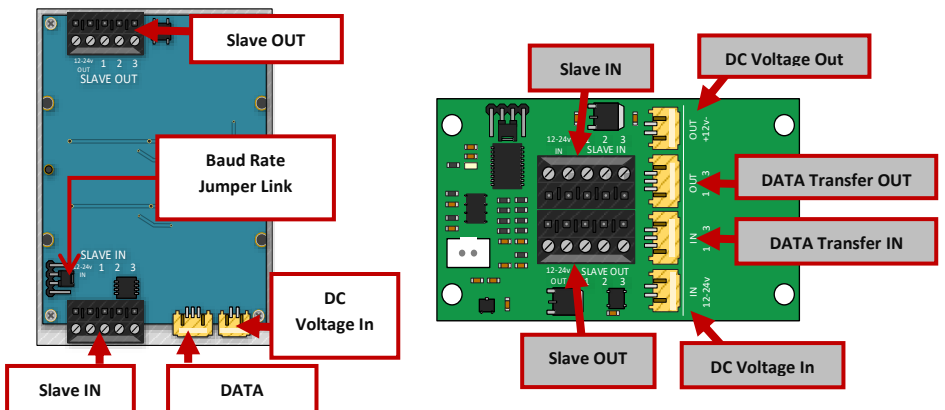

Overview of Surge PCB

*optional extra

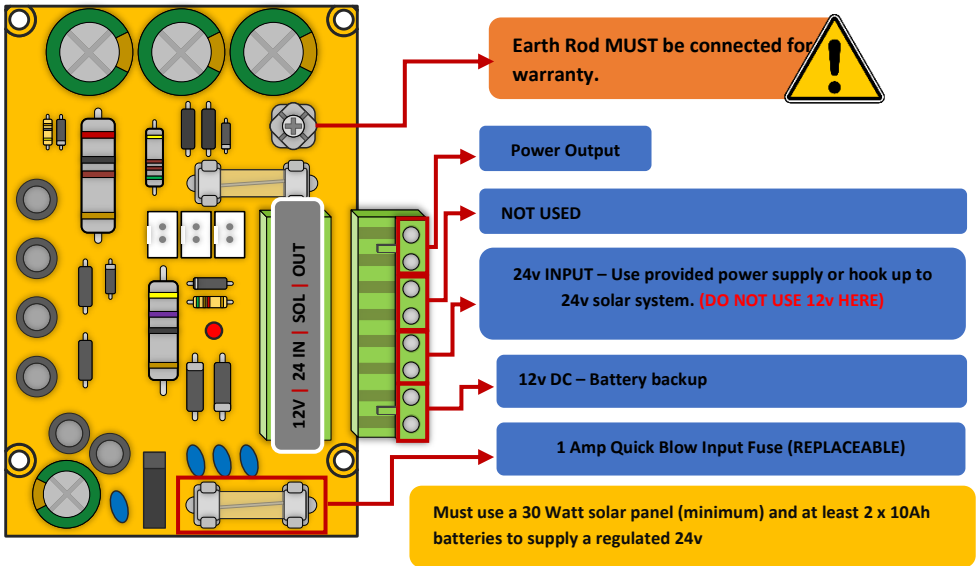

Overview of Multibutton PCB

*Multibutton Systems Only

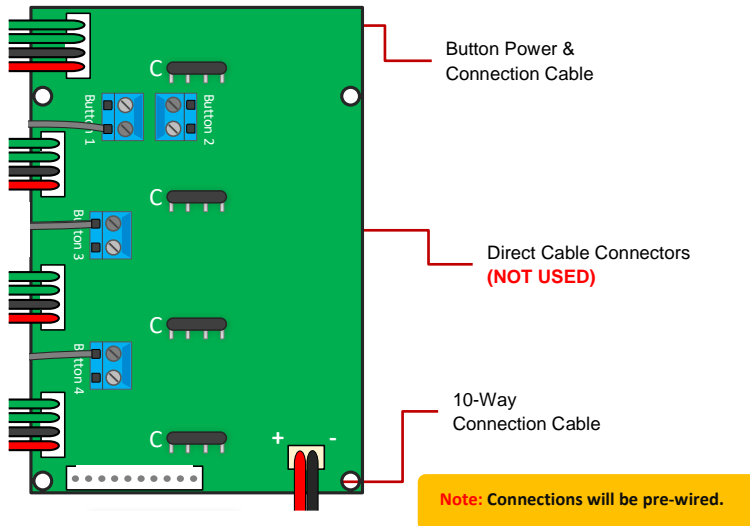

Technical Specifications

GENERAL	
Front Panel	<p>Portrait Orientation AB/ABK = 3mm Acrylic on Architectural Design Marine Grade Stainless Steel BS316 Front Plate</p> <p>AS/ASK = 3mm Marine Grade Stainless Steel BS316 on Architectural Design Marine Grade Stainless Steel BS316 Front Plate</p> <p>FS/FSK = Flush Design Marine Grade Stainless Steel BS316 Front Plate</p> <p>IMP/IMPk = 3mm Acrylic on Imperial Design Marine Grade Stainless Steel BS316 Front Plate</p> <p>Landscape Orientation PED = Pedestal Surface Mount. Powder Coated Marine Grade Stainless Steel BS316 Front Plates with 3mm Acrylic on Design Marine Grade Stainless Steel BS316 Modular Plates</p>
Hood Cover (MOD, IMP(K), PED)	Powder coated Aluminium
Mounting Housing (Backbox)	Marine Grade Stainless Steel BS316
Mounting Type	AB/AS/ABK/ASK = Surface-Mounted with backlighting, IMP/IMPk = Surface-Mounted, FS/FSK = Flush-mounted
Call Button	Stainless-steel button with illuminated LED Ring (max. 4 separate buttons)
Power Supply	24V DC
Power Consumption	<p>GSM PCB w/Keypad & Prox Standby Current: 80mA Dial Out: 300mA Max Current: 2A</p>
Solar Power	30Watt Solar Panel (minimum) 2x 12V 10AH Batteries connected in series to provide 24V output. The power output must be regulated.
Ingress Protection:	IP55
Approvals	FCC, CE
Dimensions	See catalogue
Operating Temperatures	-25 to +55°C / -13 to 131°F
KEYPAD MODULE	

Backlighting	Blue / White
Baud Rate	9600 / 115200
Code Length	4 Digits (fixed)
Confirmation Key	N/A
GSM	
Modem Models	4G Europe - SIM7500E 4G USA - SIM7500A 4G USA - QUECTEL EC25-AFX 4G AUS/NZ - SIM7500SA
Frequency Range	GSM900 880-915MHz, DCS 1800 1710-1785MHz WCDMA Band I 11920-1980MHz, WCDMA Band VIII 880-915MHz LTE B1, B3, B7 1920-9180MHz, 1710-1785MHz, 2500-2570MHz LTE B8, B20 880-915MHz, 832-862MHz
RF Output Power (EIRP)	32.55dBm (GSM 900), 29.73dBm (DCS 1800) 23.77dBm (WCDMA Band I), 23.78dBm (WCDMA Band VIII) 22.79dBm, 22.73dBm, 22.97dBm, 22.35dBm, 22.99dBm (LTE B1, B3, B7, B8, B20)
PROX TAGS	
Dimensions	40 x 25 x 4.5mm
Frequency	125 KHz
Type	Passive, fixed 10 digit.
Storage Temperatures	.-40°C to +85°C (-40°F to 185°F)
Operating Temperatures	.-40°C to +55°C (-40°F to 131°F)
Ingress Protection:	IP68

PHASE 3

Setup

(To be done before installing the intercom)

GSM Coverage

Before installing this system, you need to be sure that there is good mobile GSM cell coverage in the area it is to be installed. It is recommended that you conduct a site survey, and check reception on the site for GSM coverage. If reception is poor in the area, then this system is not recommended.

SIM Card

You will require a regular voice and text NANO SIM card with at least 250Mb of data allowance and capable of running on 4G service.

Do not use a data-only SIM, as this is only for tablets and will not work in the unit.

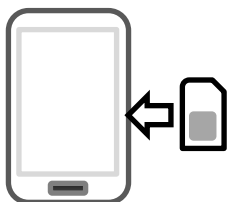

- 1a) Ensure the SIM has calling credit, and can make and receive calls on a mobile cell phone. (pay as you go)
- 2) Check that the SIM is not locked to a phone and can be used in other devices.
- 3) Check that the SIM does not have a PIN code request.
- 4) Disable voicemail service on the SIM.
- 5) You are now ready to begin programming.

Tip: IoT SIMs or certain networks may not operate as expected. Please ensure you have tested using a reputable network before reporting any faults.

If you wish to use the SIM card provided please follow the instructions with the SIM serial number. Further details can be found on our telecoms website.

www.aesglobaltelecom.com

APN Details (for VoLTE / 4G services)

To achieve a full 4G network service an Access Point Name (APN) will need to be set. The APN provides all the details that your device needs to connect to mobile data.

If you purchased the system in the below countries the APN stated will be pre-programmed for your convenience. If you purchased in a different country or wish to use a different network then the correct APN must be set for full operation.

UK – Vodafone UK | IRL – Vodafone IRL | USA – Tracfone (AT&T)

A list of the most popular APN's can be found on the website above or you can contact your network provider for this information. How to apply this is shown later in the instructions.

Inserting the SIM card

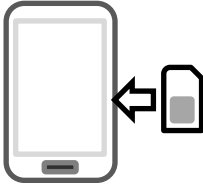

Please ensure the SIM card is a 4G NANO SIM card. Do not use a SIM card for a tablet, as these only support data, and do not support voice and SMS. You simply require a mobile phone type SIM card.

It is always good practice to check if the SIM is active by putting it into a phone and making a call.

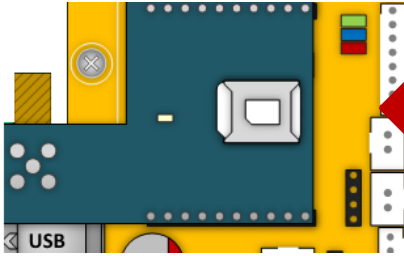

45 chamfer IN
Pads DOWN

Ensure SIM is activated.
Pre-pay SIM will need credit first.

WARNING

Ensure power is OFF. Do not hot insert or remove while power on.

Power Connections

Perform a final check of wiring and ensure the antenna is connected before switching on the power. Once the power is switched on, the power LED should illuminate.

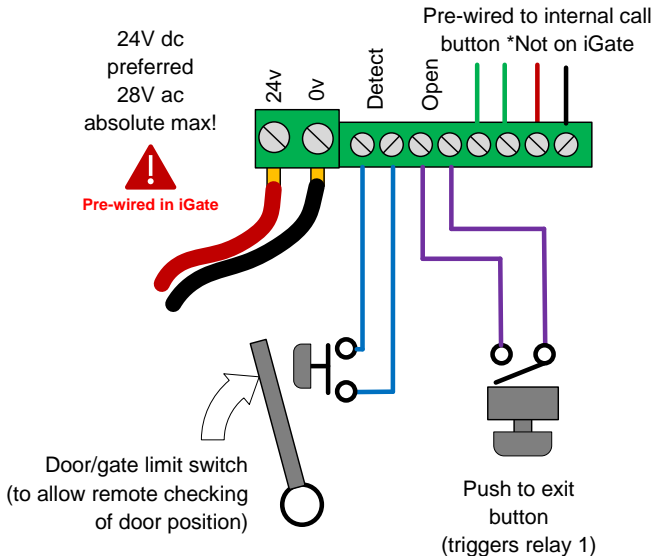

Status LED's

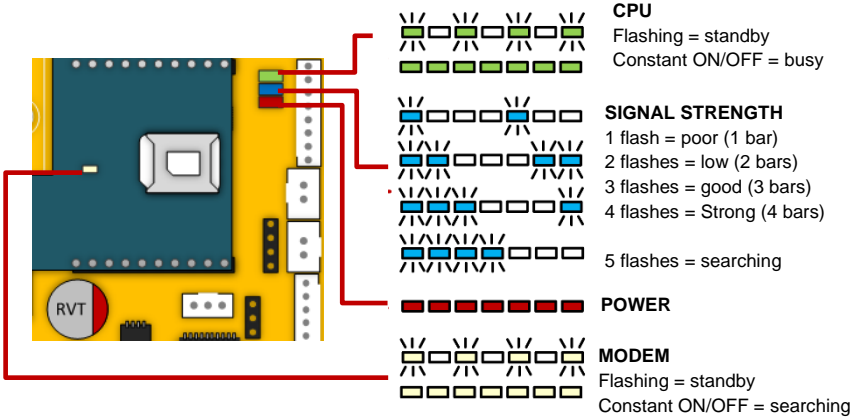

Do NOT use fine gauge cable such as CAT5, CAT6, Alarm Cable etc to power this device as damage will occur.

0-2 metres (6 feet) – min 0.50mm² (18 gauge)
2-4 metres (12 feet) – min 0.75mm² (16 gauge)
4-8 metres (24 feet) – min 1.0mm² (14 gauge)



1: Check Reception

Go to 'More > Info' & press the reception/signal level button.

On Android, the app will automatically send an SMS string (*20#) to the intercom.

The intercom should then reply with a signal level between 1 and 31.

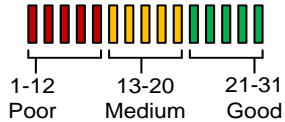

For optimal performance, the minimum signal level required is 10 on 4G systems.



Note: SMS string= *20#

1b: Set APN (for VOLTE / 4G service)

ONLY REQUIRED FOR DIAL-OUT OPTIONS & CAN BE SKIPPED IF USING THE SIM NETWORK PRESET AS DETAILED ON PAGE 22

i) App/SMS

If you have network mode showing 3G this feature may need to be set to achieve full 4G network service. Check the APN of your provider (can usually be found online) and then go to 'Manager > APN' to create the correct string like below.



ii) Manually via Keypad

If there is no 2G/3G signal in your area the system will not be able to connect to the network at all without applying the APN.

If you purchased a unit with keypad you can contact technical support for the correct APN serial code that matches the APN for the network being used, then follow the process below:

1. Short the PB terminals on the PCB before turning unit on.
2. Upon power up, a long tone will be emitted from the speaker and the blue LED will remain solid - it is now in the APN setting mode.
3. After this, enter the APN serial number through the keypad then press #. (e.g. if you want to set APN No. 18, press 1 - 8, then #. A long beep will again be heard)
4. Reboot unit.

1c: Reboot the Intercom

The intercom will need to be rebooted after either one of the above processes is completed to log on to the network with the new APN which you have stored.

If you send another reception check (*20#), you may find that if the network mode was on 3G before, that it is now on 4G mode.

PHASE 4

Installation



**ATTENTION IMPORTANT
INFORMATION**



Recommendation!

Most technical calls received are due to installers using CAT5 or alarm cable to power the unit. Neither are rated to carry enough power (2 amp peak). Please use following cables:

0-2 (0-6 ft) use min 0.5mm² (18 gauge).

2-4 (6-12 ft) use min 0.75mm² (16 gauge).

4-8m (12-24 ft) use min 1mm² (14/16 gauge).

INSECT INGRESS WILL INVALIDATE WARRANTY

We recommend sealing all entry holes for prevention of insects that can cause issues with a risk of shorting out components.



How to Achieve & Maintain IP55 Rating

The IP55 rating attached to this unit is only achieved if the below steps have been followed. This is to prevent any unwanted water and/or bug ingress that can cause various issues with functionality and will void the warranty if not followed.

Step 1 – Mount to location

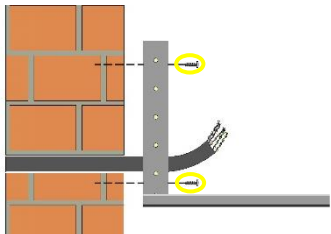

Use the pre-drilled mounting holes and cable cut outs to connect the intercom to the mounting option chosen.

Step 2 – Seal unit

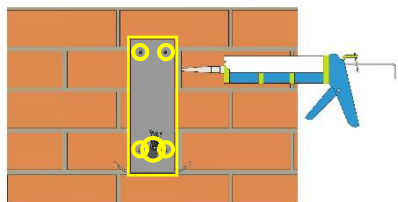

Seal all mounting or cable cut outs by using sealant such as silicone.

Ensure that any products being used are safe to use as some products can cause damage to the unit and/or the mounting location.

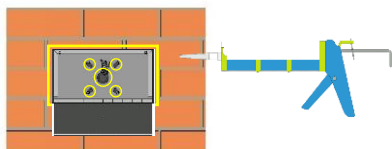

If surface mounting seal around the back box especially when used on an uneven surface.

Step 3 – Close unit

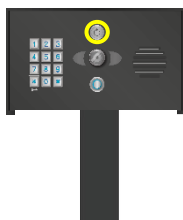

Pedestal Design



Architectural, Imperial
& Modular Design



Flush Design

Ensure the security screws or cam lock is adequately closed to ensure a correct seal.

Power

This intercom comes with a 24V dc power supply. The intercom requires up to 2 amps peak demand at times, therefore power cable is of extreme importance. Using insufficient power cable thickness will cause excessive stress on electronic components, and can therefore void the manufacturer's warranty. To avoid such problems, it is recommended (and is good practice) to locate the power supply as close to the intercom as possible. This avoids power cable noise and interference and enhances the lifetime of the product.

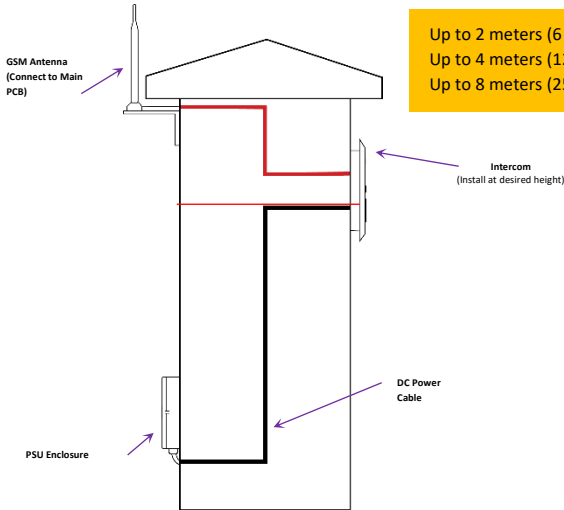

Up to 2 meters (6 feet) use minimum 0.5mm² / 18 gauge cable.
Up to 4 meters (12 feet) use minimum 0.75mm² / 16 gauge cable.
Up to 8 meters (25 feet) use minimum 1.0mm² / 14 gauge cable

Solar Power

You can use solar power if required. You will require a DC voltage regulator applied at the gate board end as the voltage output can vary and cause too high a voltage, which will damage the intercom if over the 26v DC.

Our systems would require as a minimum a 30W of solar panel capacity and 10Ah battery capacity for our intercoms.

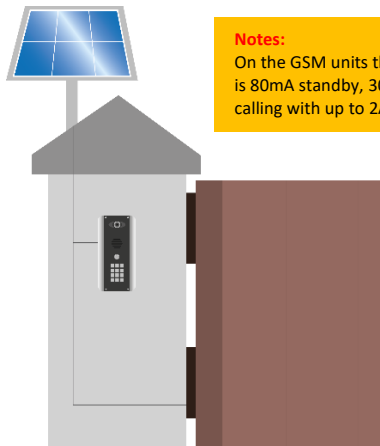

Notes:
On the GSM units the draw is 80mA standby, 300mA calling with up to 2A spikes.

Inserting the SIM card

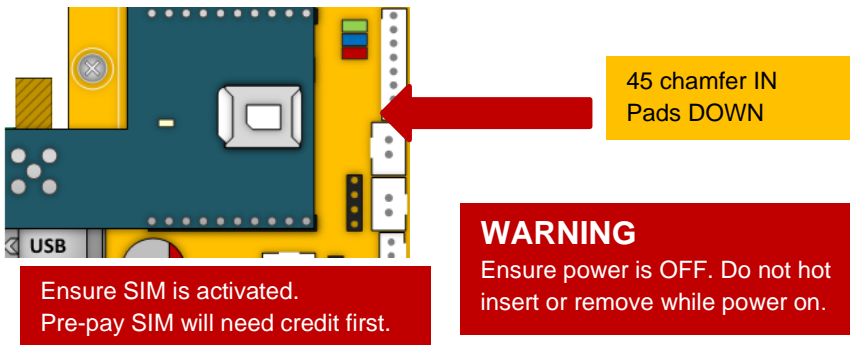

Powering Up

Perform a final check of wiring and ensure the antenna is connected before switching on the power. Once the power is switched on, the power LED should illuminate.

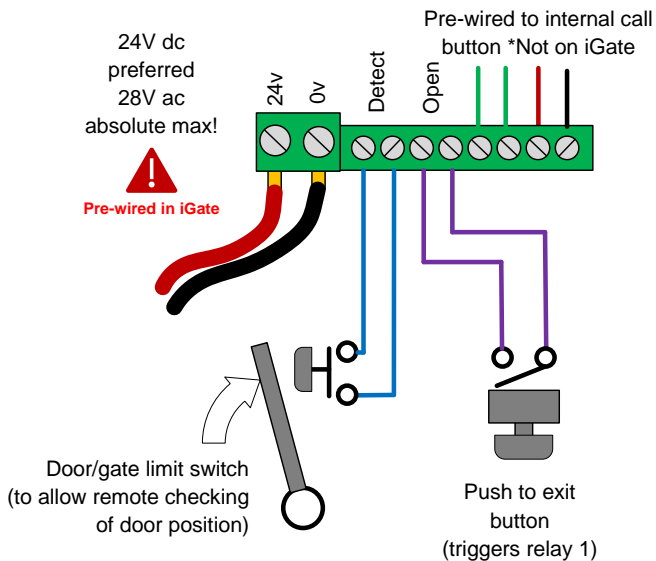

Exit Button (PTE)

When the exit button is pressed it will trigger relay 1 for the pre-programmed time in the app. (Default is 1 second)

Relay Wiring Examples

Note: The manufacturer is not responsible for wiring to third party devices. Please consult the device instructions if having issues.

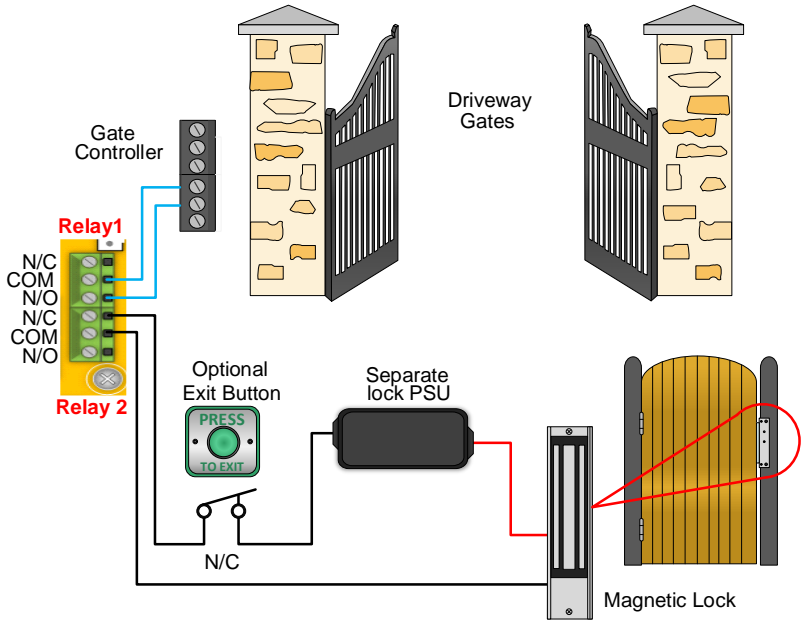

Additional Wiring Tips

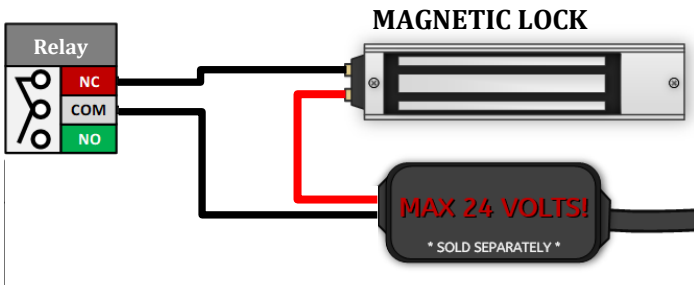
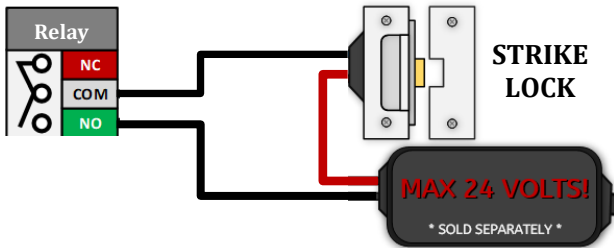

Connecting Slave Devices

***Keypad module required**

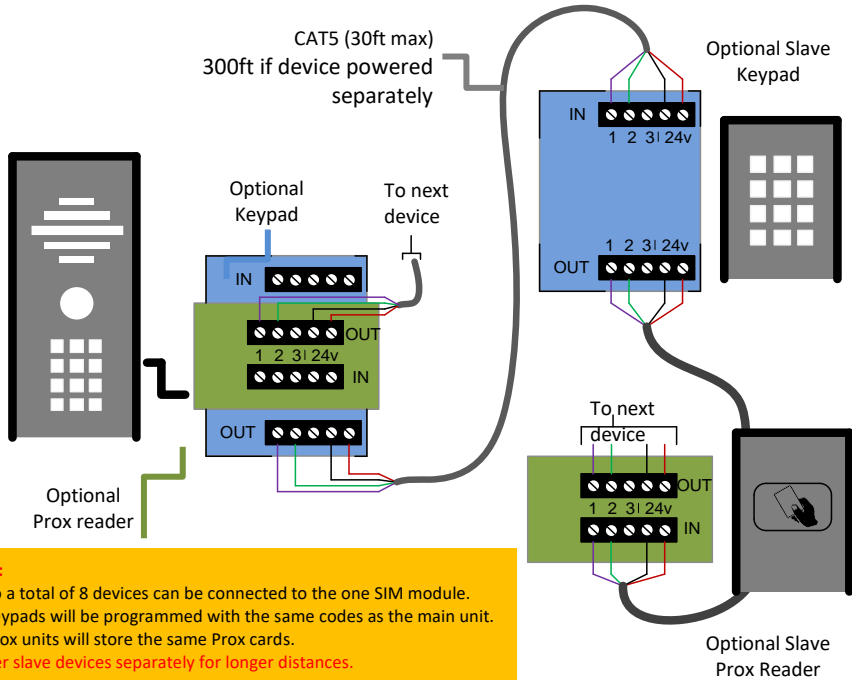

Note:

Up to a total of 8 devices can be connected to the one SIM module.
All keypads will be programmed with the same codes as the main unit.
All Prox units will store the same Prox cards.
Power slave devices separately for longer distances.

PHASE 5

App Programming

(New app release in late 2021)



Installing the Programmer APP for the first time

Step 1 - Download and install the programmer app for android or apple devices.

Search for “CellCom Prime Programmer” (or scan QR code below).

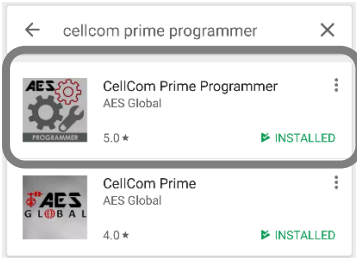

Tip: Slight differences will be seen between the Android and iOS app versions, any major differences will be highlighted in the screenshots below.

Step 2 - Open the app and allow all permissions.

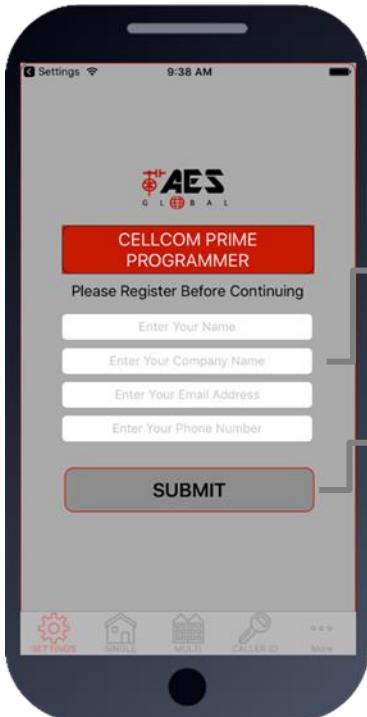

Register your details first time for support registration.

Press Submit and send your details via email client.

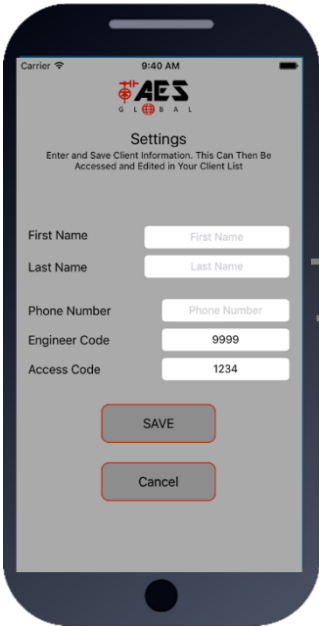

Programming a Brand-New Install

Press SETTINGS to reveal the screen shown. This screen will store details for the client.

Enter name or site name for customer.

Enter INTERCOM SIM phone number.

Default Engineer's and user's pass codes. These can be changed later.

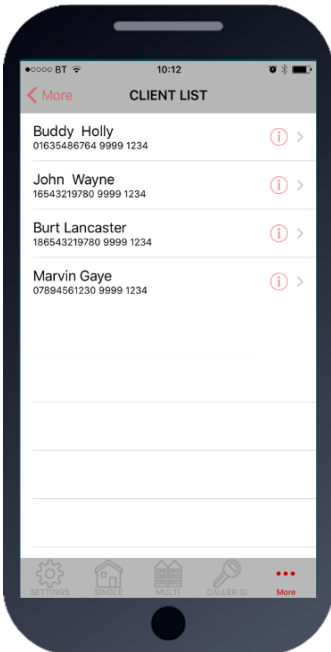

Programming an EXISTING Install

1. Go to MORE>CLIENT LIST to reveal the screen shown.

2. iPhone users press the info symbol. Android users **press and hold** the client, and then press upload to begin programming.

Note: This page will look different on Android mobile devices. See page 33 for more info.



Now you are ready to begin programming!

1: Check Reception

Go to 'More > Info' & press the reception/signal level button.

On Android, the app will automatically send an SMS string (*20#) to the intercom.

The intercom should then reply with a signal level between 1 and 31.

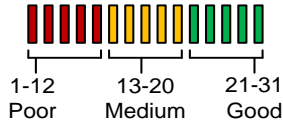

For optimal performance, the minimum signal level required is 10 on 4G systems.



Note: SMS string= *20#

TIP: If signal is lower than recommended, then take IMMEDIATE action. Change network if possible or use an optional high gain antenna. Check power cable is within recommended specification. **(Poor power cable can lower reception).**

TIP: If you have already set the APN as instructed during configuration this can be skipped.

1b: Set APN (for VOLTE / 4G service)

ONLY REQUIRED FOR DIAL-OUT OPTIONS

iii) App/SMS

If you have network mode showing 3G this feature may need to be set to achieve full 4G network service. Check the APN of your provider (can usually be found online) and then go to '**Manager > APN**' to create the correct string like below.



iv) Manually via Keypad

If there is no 2G/3G signal in your area the system will not be able to connect to the network at all without applying the APN.

If you purchased a unit with keypad you can contact technical support for the correct APN serial code that matches the APN for the network being used, then follow the process below:

1. Short the PB terminals on the PCB before turning unit on.
2. Upon power up, a long tone will be emitted from the speaker and the blue LED will remain solid - it is now in the APN setting mode.
3. After this, enter the APN serial number through the keypad then press #. (e.g. if you want to set APN No. 18, press 1 - 8, then #. A long beep will again be heard)
4. Reboot unit.

1c: Reboot the Intercom

The intercom will need to be rebooted after either two of the above processes is completed to log on to the network with the new APN which you have stored.

If you send another reception check (*20#), you may find that if the network mode was on 3G before, that it is now on 4G mode.

iGate - Programming as an Alarm Dialler Device

Intercom - Programming Numbers to call on button press

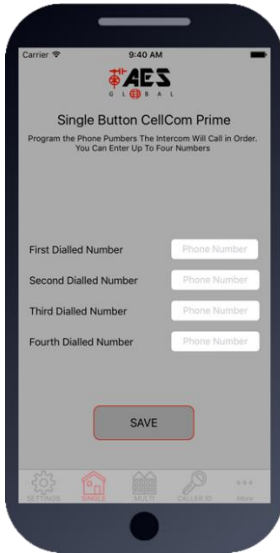

1. Press the SINGLE home icon for a 1 button system, or MULTI for a 2-10 button system.

2. Simply enter cell phone numbers and/or landline phones which the intercom is to call when the call button is pressed. (2-10 button model please enter button number. See below).

3. Press SAVE. Note: You will be taken to the SMS screen to confirm the SMS string - press send.

(some older Andriod devices may send the SMS automatically)

4. The intercom should reply with an SMS to your phone showing the SMS string and an OK status.

SMS Programming Format:

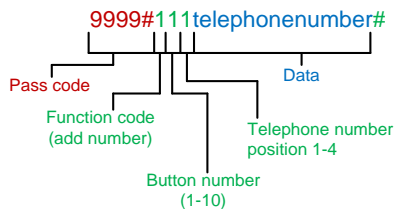

TIP: If calling a number that uses a menu system or extensions that needs an option selected please refer to the complete parameters for detail on how to perform this action.

E.g. 9999#111firstnumber#112secondnumber#113thirdnumber#

Programming Dial out numbers for Multi-Button Versions



Please note the position of the buttons on the above panel options. For example, if you have a 2 button panel, you will be programming dial out numbers for buttons 3 and 4. For a 4 button panel, the corresponding button locations are 2,3,4 and 5.

Tip: The correct button number to use when programming will be displayed on a paper insert on the intercom.



Programming Caller ID access numbers (250 max).

1. Press the CALLER ID button.
2. Simply enter cell phone numbers of visitors whom should have access with caller ID (up to 8 at a time).
3. Press SAVE. Note: iphone users will be taken to their SMS screen to confirm the SMS string (press send).
4. The intercom should reply with an SMS to your phone showing the SMS string and an OK status.

SMS Programming Method:

Add numbers:

9999#72telephonenumber#72telephonenumber#

Delete specific number:

9999#73telephonenumber#

Delete all:

9999#73*#

Switch Caller ID Trigger from relay 1 to 2.

Note: An unstored number will still trigger relay 1 via the default usercode 1234, even if Caller ID is set to relay 2

9999#54X# (X =1-2, default 1)

TIP: If you have more than 100 users requiring Caller ID, they can use a manual process to trigger the gate. When the call connects to the intercom SIM the user can manually type **1234** on their device and this will trigger the gate.

Programming Additional Features

The intercom should now be able to call users and have some basic Caller ID access. Now you may wish to program additional features for the client, including keypad codes, dialling times (to avoid voicemail on un-answered calls, auto-trigger times etc.

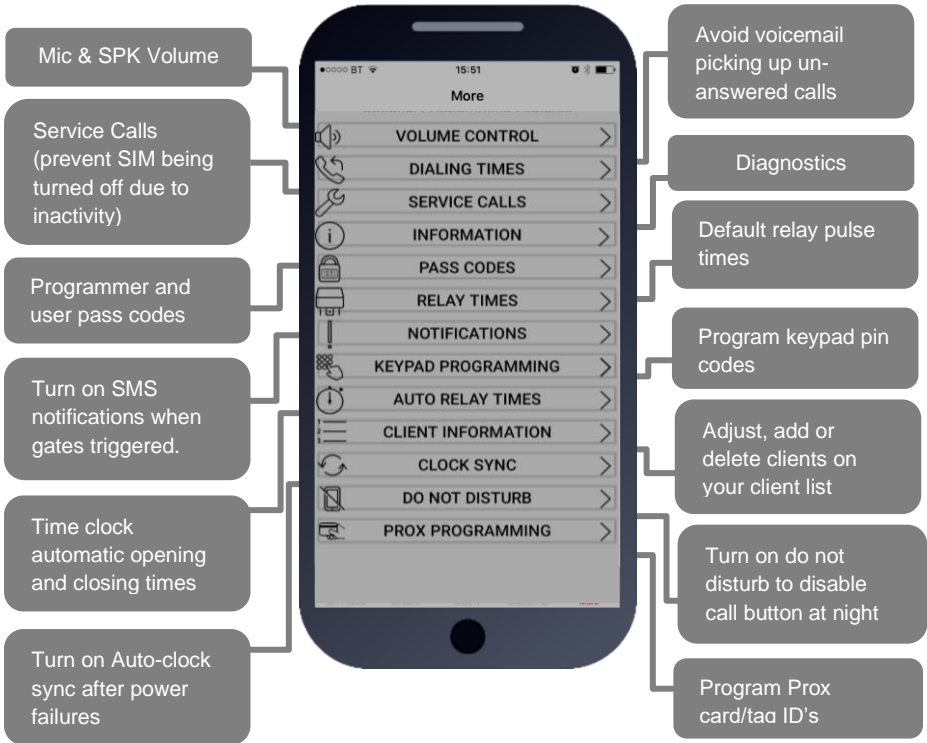

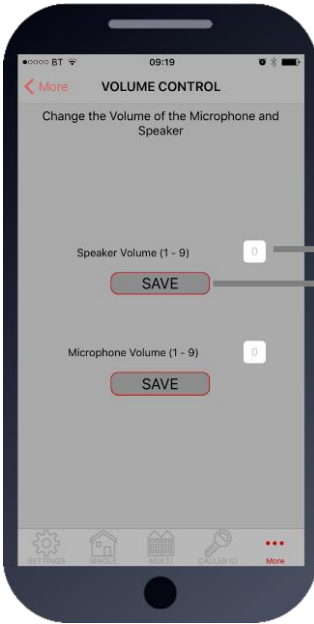

Volumes

Adjust speaker and microphone volumes.

Enter required level (1-9) for optimum speech.
TIP: Set as low as possible for good acoustics.
Default = 5

Press SAVE.

*Note: You will be taken to the SMS screen to confirm the SMS string - press send.
(some older Android devices may send the SMS automatically)*

SMS string for Speaker Volume:
9999#3X# (X=1-9, default = 5)

SMS string for Microphone Volume:
9999#4X# (X=1-9, default = 5)

SMS string for Dialling Out Volume:
9999#3*X# (X=1-6, default 3)

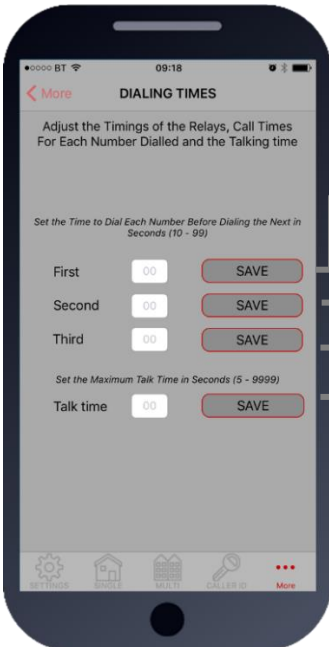

Dialling & Talk Time

Change ringing times on each number to avoid voicemail picking up a call on un-answered call so the unit can roll over to the next number.

Note: Default 20 secs (includes 5-8 sec connection time).

Dialling time for first number (default 20 secs)

Dialling time for second number (default 20 secs)

Dialling time for third number (default 20 secs)

Set MAX talking time for all numbers (default 60 secs)

SMS strings:

9999#45X# (X=dialling time for first number)

9999#46X# (X=dialling time for second number)

9999#47X# (X=dialling time for third number)

9999#53X# (X= talking time in seconds, 9999 max)

Enable abort call if answered too soon i.e. dial out phone has no signal or in airplane mode etc

9999#56X# (X=0-9 secs. 5 usually enough)

Service Calls

This feature is normally only used on intercoms which are seldom used and only for SIM cards which are likely to be de-activated by the network due to inactivity. It can be programmed to make a chargeable outgoing call or SMS to a number of your choice using this screen.

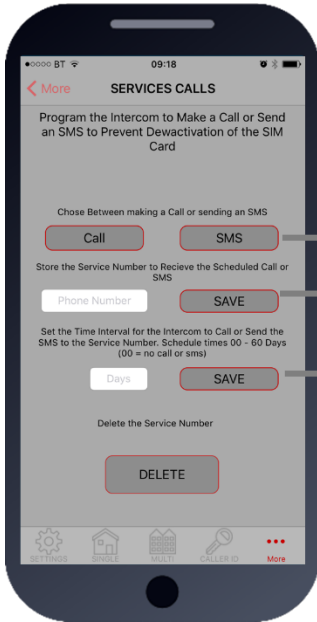

Choose SMS or CALL

Enter the phone number which is to receive the call

Enter the frequency of calls (1-60 days).

TIP: This will call or SMS at the time at which the feature was activated. So, if you set this feature up at 5pm, it will make the service call or SMS at 5pm at the next interval.

SMS string for choosing SMS or CALL:

9999#58X# (For calls, X=2, for SMS, X=1)

SMS string for entering phone number:

9999#77telephonenumber#

Delete all:

9999#77*#

SMS string for frequency of calls:

9999#57days# (0-60)

Intercom Information

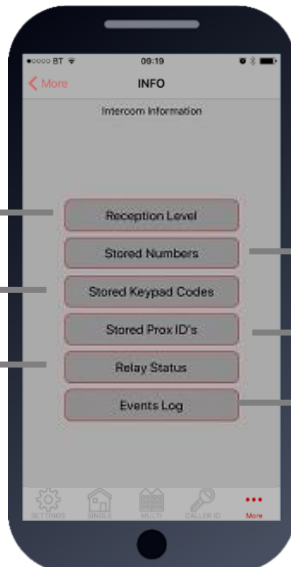

Check firmware version, signal strength, network mode & timestamp

Check stored keypad codes

Check relay status

Note: Users will be taken to SMS screen to confirm message and send.

Check stored dial out and CID phone numbers

Check stores Prox ID numbers

Check who opened the gate, when it was opened and by what method

SMS Reply Examples

***20#**

Signal=18 3G

SIGNAL STRENGTH
Will reply with signal range 1-31. Min signal level should be 10 on 4G systems

***21#**

O11:987654321
O12:123456789
I1:987654321
I2:123456789
I3:5559991234
I4:9995559876

STORED NUMBERS
O=Dial out number.
I=Dial IN Caller ID number.

1234#25#

Norm: 1234,
5555,6565,4321
Temp:
4545,7878,9876
Plan: 1010,4343

STORED KEYPAD CODES
NORM=Permanent codes.
TEMP=Temporary codes.
PLAN=Time restricted codes.

RELAY STATUS
OPEN – Shows status of the input terminals called STATUS on the intercom, can be used with a limit switch. Relay status shown to check if any relay is latched.

***22#**

Open
Relay1=OFF
Relay2=OFF

***23#**

0930-05/06/17-code-XX34
2108-04/06/17-cid-543210
2034-04/06/17-user-55987
1632-04/06/17-codeXX89

1244-04/06/17-code-XX98
0840-04/06/17-cid-995555
2109-03/06/17-code-XX34
2101-03/06/17-codeXX89

ACTIVITY LOG
Use this to see who used the intercom and when. Which pin codes were used, who used caller ID, who answered the call.
TIP: Time and date is in international military format.

Last 6 digits of caller ID user phone number

Last 6 digits of phone number which answered the gate

Last 2 digits of keypad code used

STORED PROX ID CODES
NORM=Permanent codes.
TEMP=Temporary codes.
PLAN=Time restricted codes.

1234*26#

Norm: 6897254836,
6548974581

Temp: 6989874154,
6989977415

Plan: 6985332154



Access/Pass Codes

CAUTION: Take care when changing access codes. There are 2 levels of 4-digit code (both must be different):

1. Engineers/Programmers code (default 9999)
2. Access/user code (default 1234)

You may wish to change both from their defaults for security.

Restore the app to using default codes (does not restore the intercom)

Enter new programmers code (default 9999)

Enter new user/access code (default 1234)

If changing default codes, then you will now need to update the client list before you can do any further programming.

Note: If the 1234 user access code is changed, then you will also need to change it on the homeowner / end users app.

SMS Strings:

9999#01code# (code = new programmers code)

9999#02code# (code = new user access code)

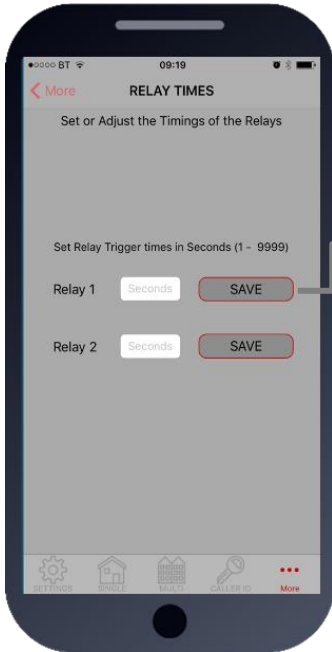

Relay Times

Relay default trigger times are 1 second. Use this feature to change a relay for a longer time perhaps for a magnetic door lock or to make one relay a momentary relay and the other a 1 hour relay for example.

Enter time in SECONDS then press SAVE to send SMS

Note: Users will be taken to SMS screen to confirm message.

SMS string for relay 1:

9999#50X# (X=time in seconds, 1-9999)

SMS string for relay 2:

9999#51X# (X=time in seconds, 1-9999)

Notifications

This feature is commonly used to allow one home user to receive SMS alerts each time the INTERCOM is used to trigger the gates and grant access.

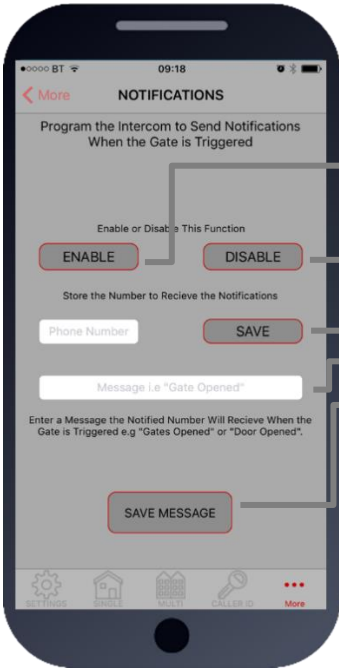

Quick Enable / disable this feature

Enter the phone number to receive the SMS alert and press SAVE

Enter text which you want the user to receive when access is granted, then press SAVE MESSAGE

SMS string for turning ON or OFF:

9999#80X# (X=2 to enable, X=1 to disable)

SMS string for entering phone number to receive notification:

9999#78telephonenumber#

Delete all:

9999#78*#

SMS string for entering text to display:

9999#79text# (text you wish to display e.g. Gates Opened)

Keypad Programming

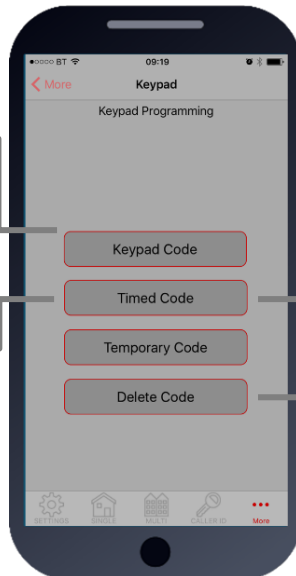

For Permanent 24/7 Codes

For temporary codes (codes which auto-expire in a pre-set time)

For Time Restricted Codes (codes that work during certain times & days of the week)

For deleting codes

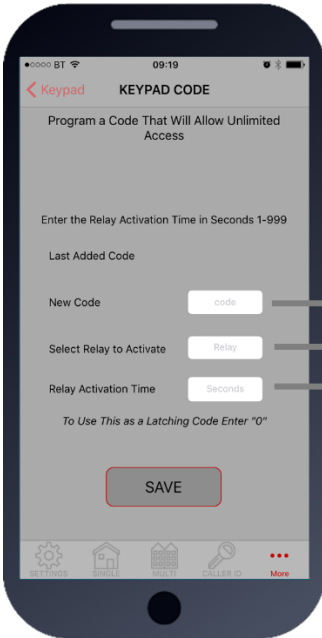

Permanent Keypad Code

Stores up to 200 codes, all of which can be used to gain access 24/7.

Enter 4 digit code

Choose Relay 1 or Relay 2

Enter activation time. (0-9999 seconds)
Use 1 second for gate trigger.
Use approx. 5 secs for magnetic locks.
Use 0 for latching or toggle code.
Use 3600 secs for 1 hour hold open on gates

SMS String for adding keypad codes:

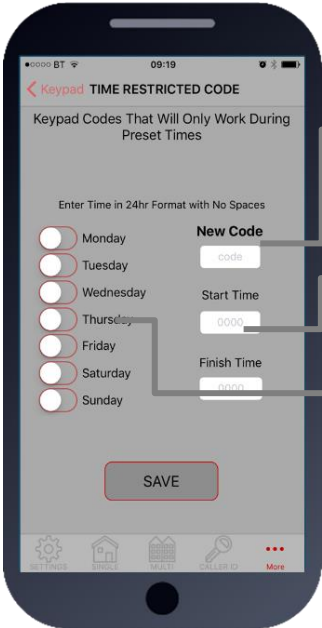
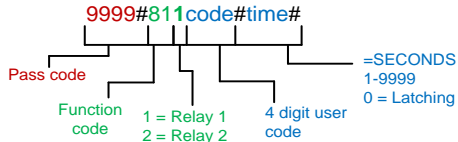

Time (Restricted) Code

Stores up to 20 codes which will only work during pre-set times and days of the week. (Relay 1 only).

Enter 4 digit code

Enter Start and Finish time
(Military format without any colons.
E.g. 8am = 0800. 11pm = 2300)

Select days of the week the code is to be active.

SMS String for time restricted code:

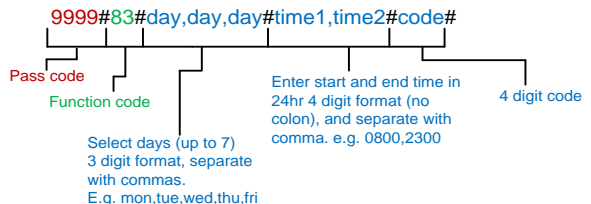

Temporary Code

Stores up to 30 codes at any time which will auto expire after a pre-set countdown time (1-168 hours) (Relay 1 only)

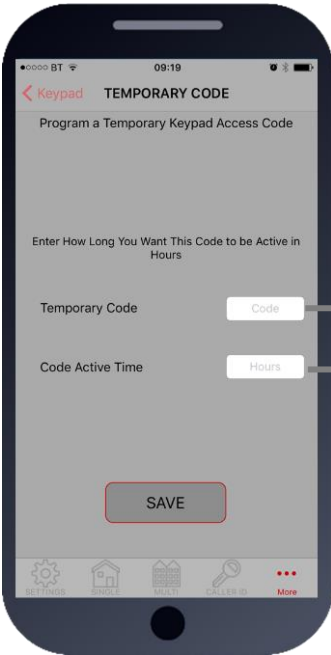

Enter 4 digit code

Enter countdown time in hours (1-168 hrs)

SMS String for temporary code:

9999#82#hours#code#

Pass code Function code Can be between 1-168 hours 4 digit code

Delete Codes

You can use these buttons to delete a recently stored temp or time restricted code (codes shown beside the delete button)

Delete any known code

Delete ALL codes

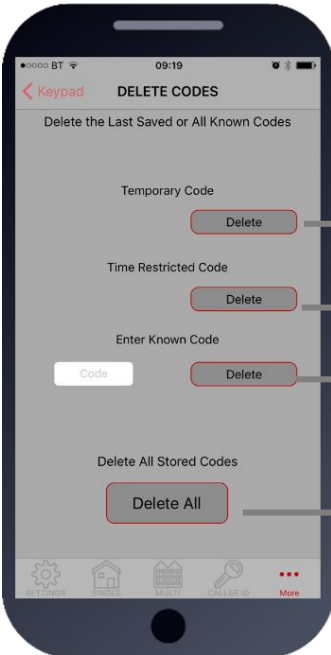

SMS String for deleting a known code:

9999#84#code#

Pass code Function code Code to be deleted

Deleting ALL codes:

9999#84*#

Auto Relay Trigger Times

Create up to 40 automatic time clock events to trigger or latch/unlatch gates (depending on gate system setup). For auto closing gates, send latch command at the desired opening time, followed by a separate unlatch event to close at the desired closing time.

For step-by-step operated gates (non auto-closing), then send a momentary trigger command at the time required to change the state of the gates from open to closed or closed to open.



1. Pick the type of event (momentary/latch/unlatch)

2. Choose the days

3. Enter the time in military 24hr format without colon
E.g. 8.30am = 0830. 11:10pm = 2310.

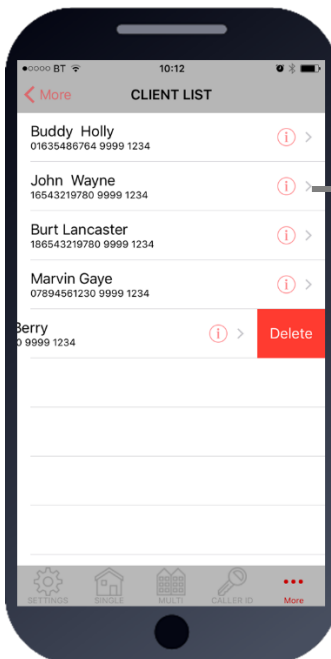
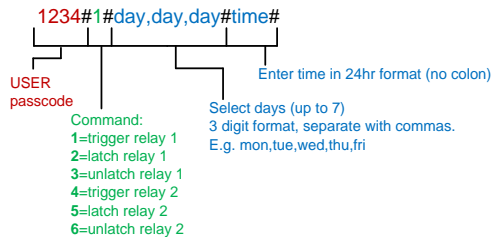

Client list on iPhone

The client list allows you to save sim phone number, customer name and pass codes for all your installs.

Press to select Client

Swipe to delete

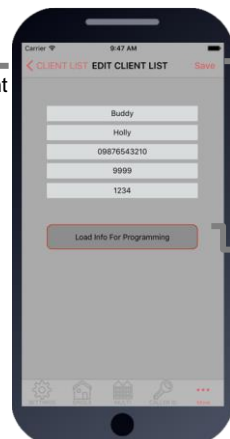

Press to SAVE after editing

Press to load details & program

On any previous install, you can load the customer and then re-program their intercom.

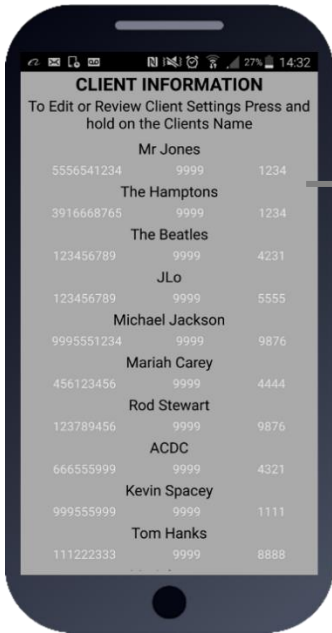

Client list on Android

The client list allows you to save sim phone number, customer name and pass codes for all your installs.

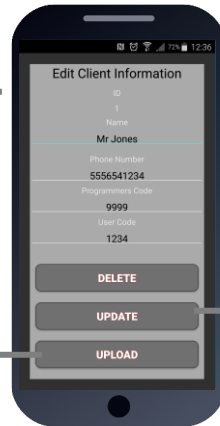

Press & HOLD to select Client

Press to load details & begin programming

Press to save changes

On any previous install, you can load the customer and then re-program their intercom.

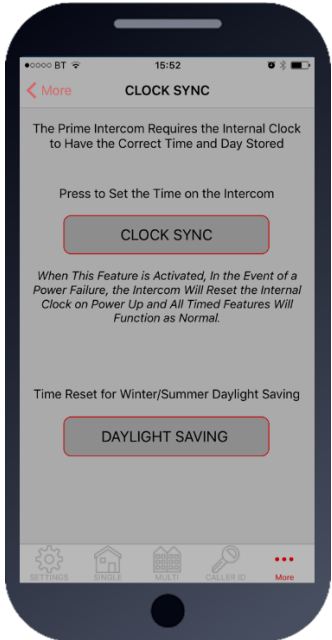

Clock Sync

The unit has an internal time clock counter, which reads the time from an incoming SMS message, and uses this to calibrate its time clock.

For power failure events, this feature allows the unit to send a SMS to itself after a power failure.

Simply press the button and the app will send a SMS string to the intercom storing the phone number from the SIM card inside memory.

TIP: Use this if your area experiences regular power cuts and your client is using timed features.

Note: Using this feature will cause the unit to be busy for 2-3 minutes after a reboot. Please be patient with programming etc after a re-boot.

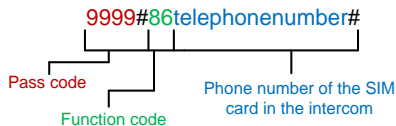

TIP: 9999#86*# will delete this number again

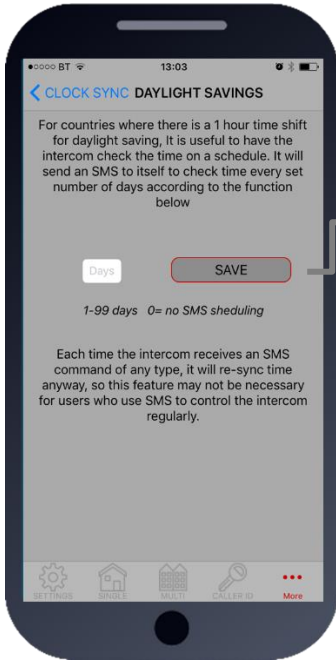

Daylight Saving

For regions where there is a 1 hour time shift for daylight saving, it can be useful to have the intercom send itself a SMS every set number of days to re-synchronise the internal clock. The intercom will do this anyway each time a SMS is received.

Set the number of days between SMS message sending (depending on carrier provider, this may be chargeable to the customer).

9999#87??#

Pass code: 9999
Function code: 87
1-99 days: ??
0= no SMS scheduling

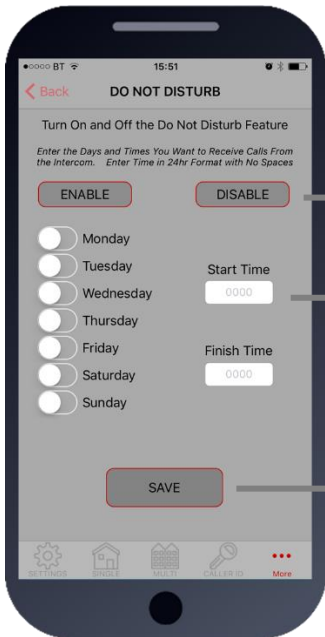

Do not disturb

This feature allows the push button on the intercom to be active during pre-set times, and ignore button presses all other times. Use this screen to set the **ACTIVE** times and days for the button.

Quick enable/disable button

Select start and finish times for the button to work (24hr format, no spaces or colon. E.g. 8:30am = 0830)

Press save to send SMS command.

9999#21#day,day,day#time1,time2#

Pass code: 9999
Function code: 21
day,day,day: Select days (up to 7)
3 digit format, separate with commas.
E.g. mon,tue,wed,thu,fri
time1,time2: Enter start and end time in 24hr 4 digit format (no colon), and separate with comma. e.g. 0800,2300

To activate, enter the following code:
1234#21#ON# (change ON to OFF to disable again).

After Hours / Out of Hours

If you have activated the do not disturb feature, the push button will not call anyone after the pre-set time threshold. However, sometimes it is useful to have the intercom call a different number after hours. For example, in commercial premises it can call the office phones during business hours, and then call a security guard after hours.



1. Enter phone number to call after hours.

2. Enter button number (enter 1 for single button system)

3. Press SAVE to confirm and send SMS

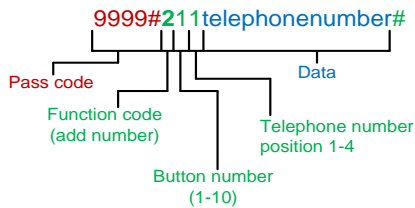

Programming Proximity Cards

Up to 200 Prox cards can be added

Temporary Prox cards or tags (30)

Delete cards or tags



Select which type you have (2G/3G OR 4G)

Note: Android users press this to choose. iPhone users will see it as 2 different tabs



Time restricted Prox cards or tags (20)

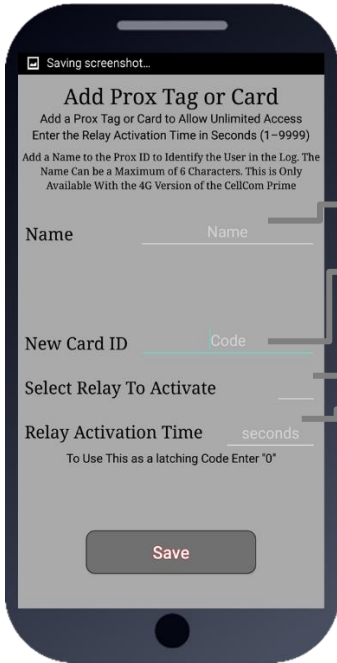

Permanent Prox card/tag

Add up to 200 cards or tags for RFID access.

Note: On 4G version, you may enter a nickname for a card which can be useful when identifying card users later. For 2G and 3G versions, ignore the name field.

Enter nickname up to 6 digits long. **(4G Only)**

Enter the 10 digit card ID number.

Select relay 1 or 2.

Enter relay activation time in seconds.

SMS String for adding Prox cards/tags:

9999#611cardID#time#

Pass code Function code 1 = Relay 1 2 = Relay 2 10 digit card ID =SECONDS
 1-9999 0 = Latching

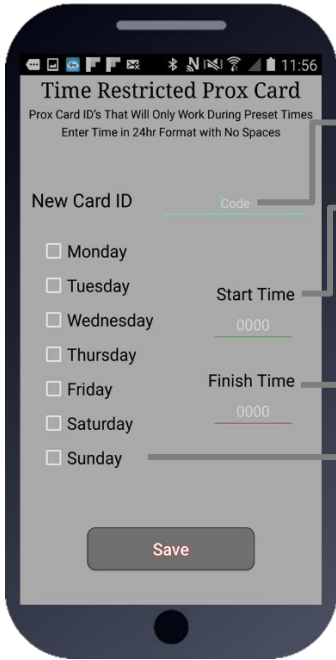

Time Restricted card/tag

Add up to 20 cards or tags for time restricted access for certain times or days of the week (relay 1 only).

1. Enter serial number of card (last 6 digits).

2. Enter start time (24hr format, no colon or spaces)

3. Enter end time (24hr format, no colon or spaces)

4. Select days of the week

SMS String for time restricted card/tag:

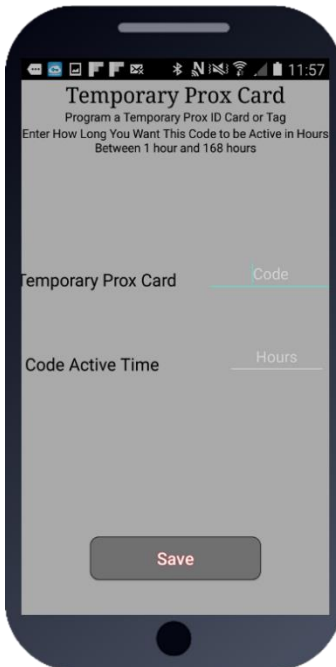
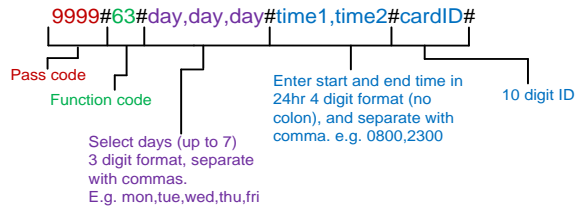

Temporary card/tag

Add up to 30 cards which will only be active for a certain time period, from 1-168 hours and then will be auto deleted from the system.

SMS String for temporary card/tag:

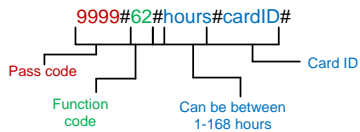

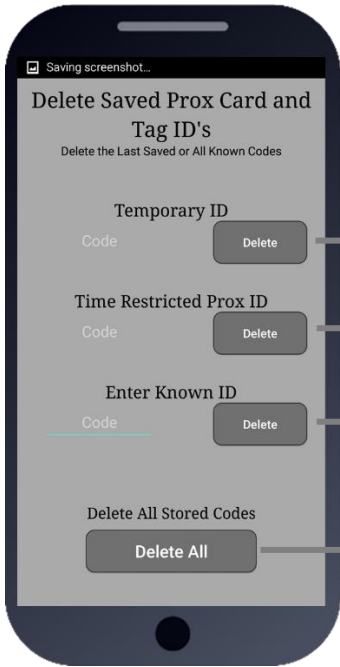

Deleting cards

This screen allows any known card ID to be deleted (by serial number), and it will also show the last stored cards for each type of card.

Delete the last stored temporary card.

Delete the last stored time restricted card.

Delete any known card ID.

Delete ALL stored cards.

SMS String for deleting a known code:

9999#64cardID#

Pass code Function code Card ID to be deleted

Deleting ALL codes: 9999#64*#

PHASE 6

Using the Intercom

(Only to be done after the unit is successfully programmed)

Calling a Resident

Single Button



1: Press the Call Button

Multi-Button



1: Press the Call Button

Tip: Press the call button again to cancel a call

Using Keypad Codes & Prox IDs (Keypad / Prox Units)



Receiving A Call and Opening Gates / Door

Visitors can press the call button, which will initiate a call from your intercom to the designated phone numbers which will have been programmed by your installer.

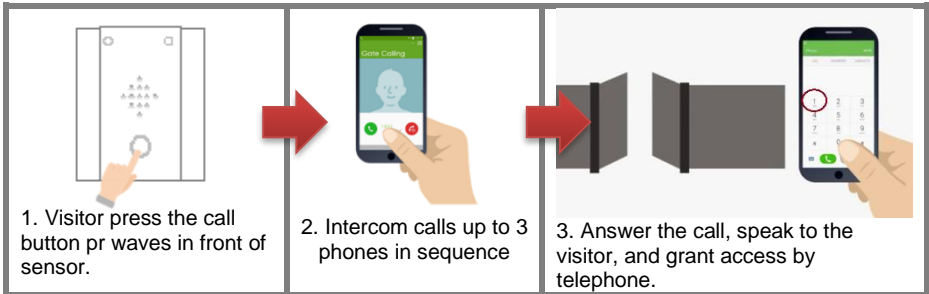

Tip: Press/Wave again to cancel the call

Output 1

This is usually main gate/door.

Press 1# to open

Press 2# to hold open

Press 3# to un-hold

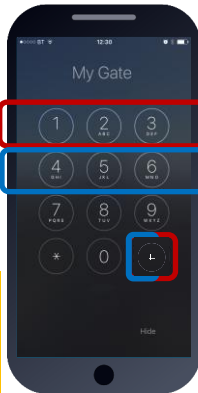

Output 2

This can be pedestrian gate, driveway lights or other.

Press 4# to open/activate

Press 5# to hold open/on

Press 6# to un-hold/off

DISABLE DTMF Confirmation
 Remove the '#' confirmation. Press 1, 2, 3 to trigger, latch & unlatch.
 (False triggering may occur when disabled)

9999#52X#
 (X=1 enable; X=0 disable)

ENABLE Latching feature via DTMF.
 If latching is required.

9999#95X#
 (X=1 enable, X=0 disable)

Access Control by Calling the intercom (CallerID)



All residents can call the intercom to gain access at no call charge using CallerID.

To open, simply ensure you have the phone number programmed for CallerID and then call the intercom phone number from the stored number and the relay will trigger as per programmed.

Using the CellCOM Prime App

You can use the free Cellcom Prime app on Android phones and iPhones. Look for the icon below or scan the QR code.

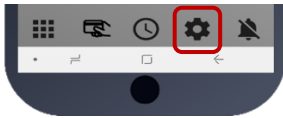
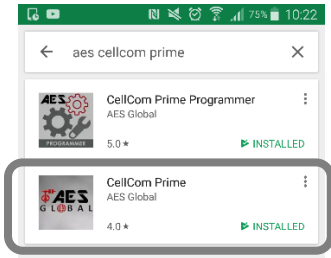

1. Install + launch the app, & accept all permissions. Press **SETTINGS**.

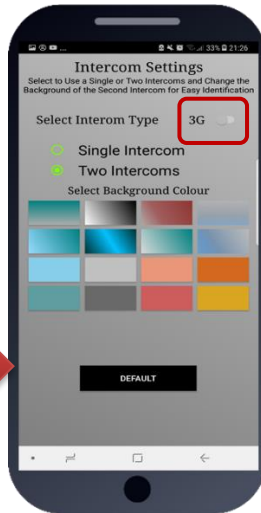
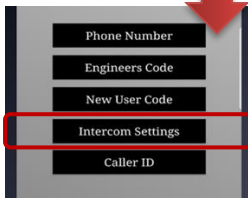

2. Select 4G (this changes how the Proximity part works)

3. Select Single Intercom if you have only one intercom and one entrance. Select two intercoms if you have 2 gate entrances with intercoms fitted. You can select a different background colour for dual intercom operation so that you know which intercom you are controlling.

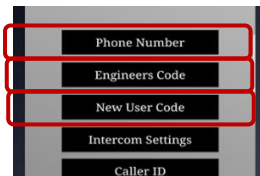

4. Store the phone number of the intercom SIM card in the phone number screen.



5. If the installer has changed the engineer's code, they can enter it here.

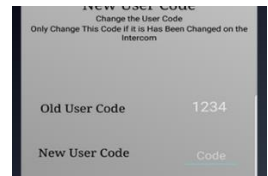

6. If the user code has been changed, enter it here.

IMPORTANT: Android users, if you receive an error message "Command Failed", go to **Phone Settings/Application Manager/Permissions**, and turn on all permissions for the app & check the intercom phone number is stored in the app.

Note: Press # to cancel call. If the engineers or user passcodes have been changed by another user you must manually update your app to allow it to generate the correct SMS string.

Summary of the App Home Screen

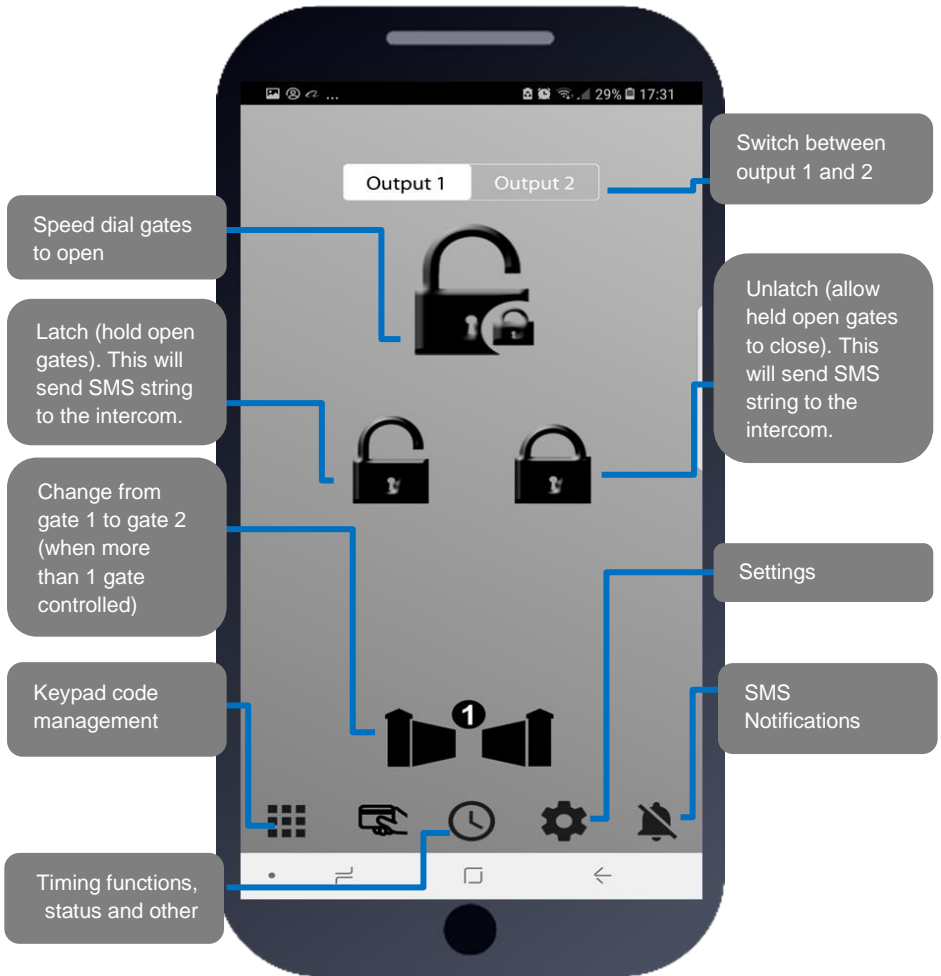

Note: Due to security restrictions, any SMS button commands will take you to your native SMS screen where you must re-confirm the SMS before it will send.



Opening the gate by App

Press the main button as shown. On Android phones it will automatically call the intercom and trigger the gate/door. For iPhone, it will take you to your dialling screen with the number pre-loaded and you can press to dial (this is a security feature by apple).

Note: Your installer will need to store your phone number in the intercom before this speed dial feature will open the gate.

Adding Keypad Pin codes (Keypad models only)

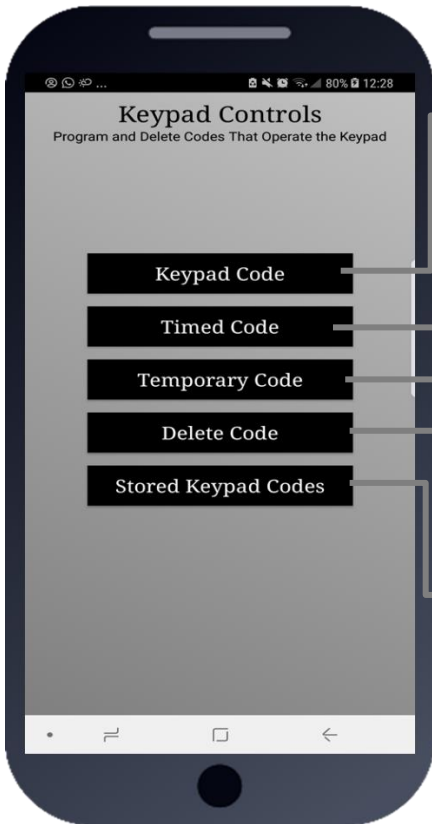

Use this to add up to 200 permanent 24/7 codes.

20 time-restricted codes (only work during pre-set days and times of the week).

30 auto-expiring temporary codes.

Delete any code.

Check stored keypad codes (will send SMS reply with list of codes).

NORM = Normal codes, can be used 24/7.

TEMP = Temporary codes which will auto expire.

PLAN = Time restricted codes

Permanent Codes

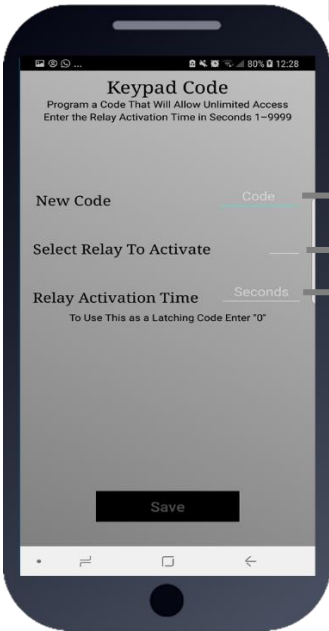

Add a new code (up to 4 digits)

Enter 1 for the main output relay, or 2 for the secondary output (ask your installer if this is being used)

Can be 1 to 9999 seconds (2.7 hours).

For Automatic Gates

Enter 0 for a latching code (hold open).

Enter 1 sec to trigger normally.

Enter 3600 for a 1 hour hold open code.

Note: Latching and hold open only work for selected types of gate installs (ask your installer).

For Strike Locks enter 1 sec, mag locks 7 secs

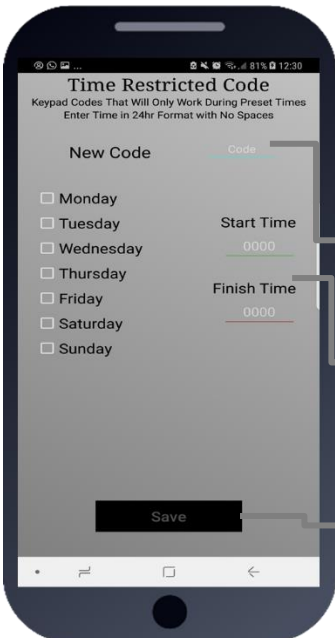

Time Restricted Keypad Pin Codes

Up to 20 codes can be added which will only operate during pre-set times and days of the week. This is useful to improve security by giving pin codes which will only work during desired hours and days of the week.

Add a new code (up to 4 digits)

Select the days during which the pin code should work, and between which times. Note: Enter time in 24 hr military format with no colons. E.g. 9am = 0900. 5pm = 1700.

Press Save to send SMS (iphone users must also confirm from SMS screen).

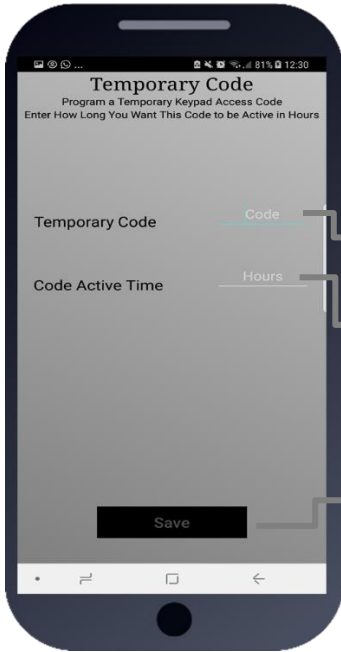

Auto-Expiring Temporary Codes

Up to 30 codes can be entered along with an auto expiry time in hours, from 1 hour to 168 hours (1 week). Once the time has expired, the keypad code will automatically be deleted from the memory.

Add a new code (up to 4 digits)

Enter the expiry time in hours (1-168)

Press Save to send SMS (iphone users must also confirm from SMS screen).

Adding Proximity Cards (Prox capable models only)

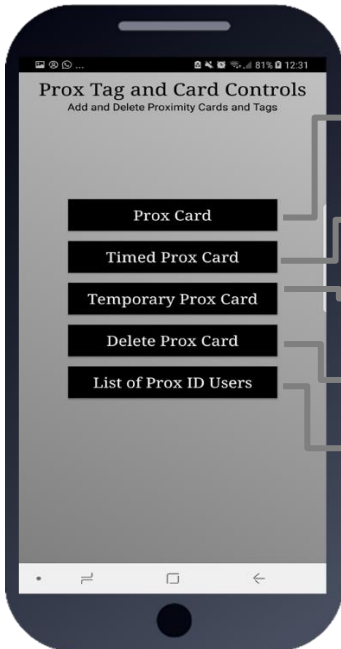

Add up to 200 proximity cards (24/7 access).

Add up to 20 time restricted prox cards (only work pre-set times and days of the week).

Add up to 30 temporary auto-expiring prox cards

Delete Prox cards

Check stored Prox cards (will send SMS reply with list of card serial numbers).

NORM = Normal codes, can be used 24/7.

TEMP = Temporary codes which will auto expire.

PLAN = Time restricted codes

Permanent Cards/tags

Add Prox Tag or Card
Add a Prox Tag or Card to Allow Unlimited Access
Enter the Relay Activation Time in Seconds 1-9999
Add a Name to the Prox ID to Identify the User in the Log. The Name Can be a Maximum of 6 Characters. This is Only Available With the 4G Version of the CellCom Prime

Name

Enter All 10 Digits

New Card ID

Select Relay To Activate

Relay Activation Time
To Use This as a Latching Code Enter "0"

Save

Store a 6 character nickname along with the card ID. This is useful when using the activity log to determine which card was used and at what time. E.G. PaulH, JohnS, AndyH etc. These names will show in the activity log.

Add a new card (enter all 10 digits)

Enter 1 for the main output relay, or 2 for the secondary output (ask your installer if this is being used)

Can be 1 to 9999 seconds (2.7 hours).

For Automatic Gates

Enter 0 for a latching code (hold open).

Enter 1 sec to trigger normally.

Enter 3600 for a 1 hour hold open code.

Note: Latching and hold open only work for selected types of gate installs (ask your installer).

For Strike Locks enter 1 sec, mag locks 7 secs

Time Restricted Prox Cards

Time Restricted Prox ID
Prox Card ID's That Will Only Work During Preset Times
Enter Time in 24hr Format with No Spaces

Enter All 10 Digits

New Card ID

Monday

Tuesday

Wednesday

Thursday

Friday

Saturday

Sunday

Start Time

Finish Time

Save

Up to 20 cards can be added which will only operate during pre-set times and days of the week. This is useful to improve security by restricting access to certain times.

Add a new card (enter 10 digit serial number)

Select the days during which the card should work, and between which times. Note: Enter time in 24 hr military format with no colons. E.g. 9am = 0900. 5pm = 1700.

Press Save to send SMS (iphone users must also confirm from SMS screen).

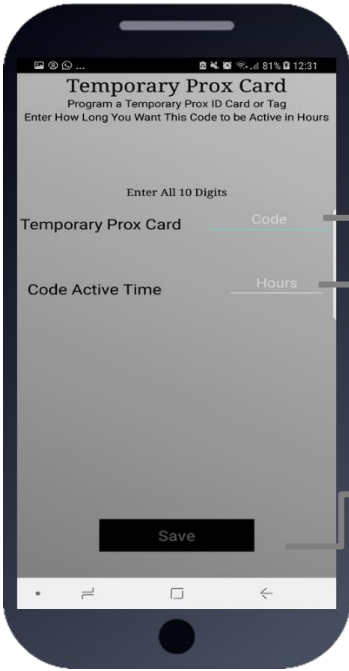

Auto-Expiring Prox Cards

Up to 30 cards can be entered along with an auto expiry time in hours, from 1 hour to 168 hours (1 week). Once the time has expired, the card will automatically be deleted from the memory.

Add a new card

Enter the expiry time in hours (1-168)

Press Save to send SMS (iphone users must also confirm from SMS screen).

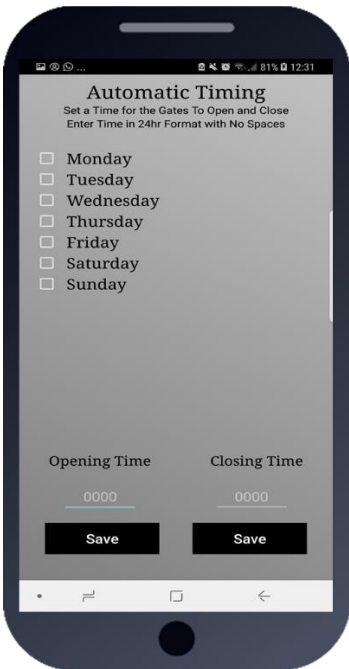

Time Clock opening and closing of gates

Note: There are 2 main ways your installer can set up gate automation. 1: Automatic closing – this is when you typically open your gates via intercom or fob, and they close automatically again after a pre-set time delay. If your gates operate in this way, then you can use this screen to control them to open and close at pre-set times of the day and week.

Step1 – Select the days you wish to open, and type in an opening time in 24hr format, e.g. 830am = 0830. Press SAVE. This will automatically latch on the main relay 1 on the intercom at that time for each day selected.

Step2 – Select the days and times that you may wish for the gates to close automatically again, say for example at night, and enter that time in the CLOSING TIME space and press SAVE.

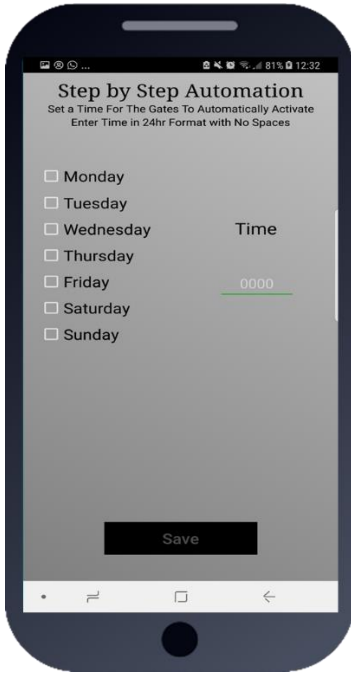

Step-by-Step Gates

[timeclock/automatic/step-by-step](#)

This screen is used for gates where typically if you use the intercom or a fob to trigger your gates to open, they remain open until such times you decide to close them again and press the fob or trigger from intercom again.

You can select days and times to trigger the gates automatically so you don't have to. For example, some home owners keep their gates open all of the time, but would like them to close automatically at night. In this example, select all the days, and enter time. E.g. 11.30pm = 2330. Press SAVE.

This will send a momentary command to the gate each day at the set time and trigger it to open if it is already closed, or close if it is already open.

You may have up to 4 opening or closing events per day.

Status Options (Press Clock button, then Status)

These buttons are useful to manage your intercom, visitors, access, and the current status of the gates for example.

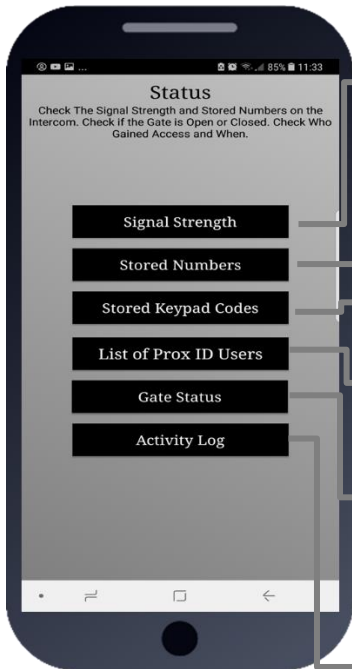

Can be used to check if the intercom reception is ok. You will receive a SMS reply with a signal level on a scale of 1-31

Check stored phone numbers for dial out and CallerID access.

Check stored keypad codes

Check stored proximity card users

Used to check if your gates are open or closed, depending on your configuration. If in doubt, ask your installer how this feature can be used.

Used to check who opened or triggered your gates and when. Get a SMS reply with pin codes, prox cards, and caller ID access used with time and date.

Firmware:Cellcom Prime
V2.0.1
Network mode:4G
Date:22/06/21
Time:12:14
Signal level:18
APN:wap.vodafone.co.uk

*20#

Signal Strength

This button will send the SMS *20# to the intercom. It should reply as shown and will indicate network type and firmware version. Should the signal level read below level 10, look at relocating the antenna, trying a high gain antenna to boost reception or try an alternative network provider.

O11: 9876543210
O12: 9995554321
I1: 9876543210
I2: 9995554321

*21#

Stored Phone Numbers

This button will send an SMS string to the intercom to check the phone numbers which are stored in the unit.

Dial Out

O11 = Button number (1-5), dial out sequence (1-4).

CallerID

I1 = Dial in CallerID numbers programmed.

Stored Keypad Codes

This button will send an SMS string to the intercom to check the keypad codes which are stored in the unit.

Norm: 6897R1, 6548R5
Temp: 6989R2,
Plan: 6985R3

1234#25#

NORM = Normal codes, can be used 24/7.

TEMP = Temporary codes which will auto expire.

PLAN = Time restricted codes.

R = Relay number programmed for.

Stored Prox cards

This button will send an SMS string to the intercom to check the serial numbers of stored cards.

Norm: 6897254836R1,
6548974581R4
Temp: 6989874154R1,
6989977415R1

1234#26#

Gate Status

This button will send an SMS string to the intercom to check the state of both relays and the optional "Status" input (gate can have a limit switch fitted for the status feature).

Relay1 = ON
Relay2 = OFF
Status = Open

*22#

If any relay is ON, it is possible your gates are held OPEN by the intercom. You can press the UNLATCH button on the home screen to send the UNLATCH command and then check again the status of the gate.

0930-05/06/21-code-XX34-R1
1345-05/06/21-CID-543210
2034-04/06/21-user-55987
1632-04/06/21-code-XX89-R2
1244-04/06/21-code-XX98-R2
0840-04/06/21-CID-995555
2109-03/06/21-code-XX34
2101-03/06/21-code-XX89-R2

*23#

Activity Log

This button will ask the intercom to send a series of SMS messages to your phone which will indicate the last 20 events that have occurred on the intercom, starting with the most recent. This can be used to see who gained access and when.

CODE = Keypad PIN code used to gain access (only last 2 digits of code shown).

CID = A known user used called the intercom to gain access with Caller ID.

USER = This person answered their phone to the visitor (Last 6 digits of phone number).

R = Relay Triggered

Note: Please refrain from pressing the LOG button more than once at a time, as doing so can overload the intercom with message requests and it may need powered off and on again to resume normal operation.

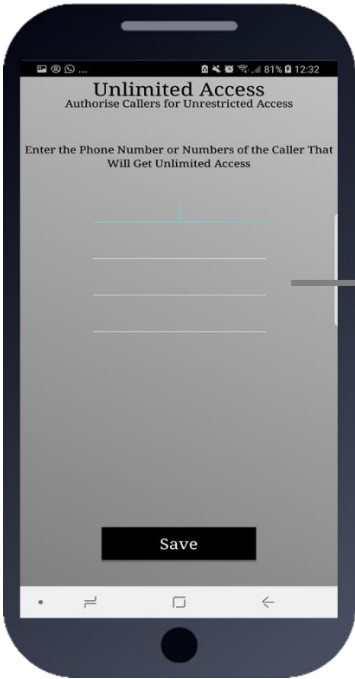

24/7 Caller ID access (Settings button/caller ID)

This intercom can store up to 100 visitor phone numbers which can call the intercom at any time. The intercom will recognise their incoming number, hang up, and grant

Enter up to 4 phone numbers at a time, and press SAVE to send the programming SMS.

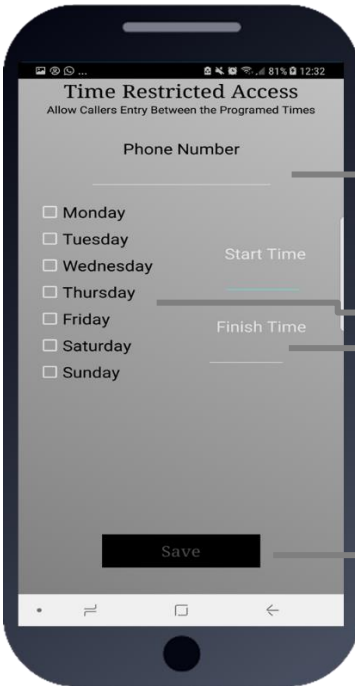

Time Restricted Caller ID Access

This intercom can store up to 20 phone numbers for visitors whom you wish to grant time restricted callerID access, e.g. maintenance person, gardener, etc.

Enter the phone number which is to have time restricted access.

Select the day or days in which they should have access.

Enter the start and finish time for access in 24hr format. E.g. 830am = 0830. 11:20pm = 2320.

Press SAVE to send the SMS string.

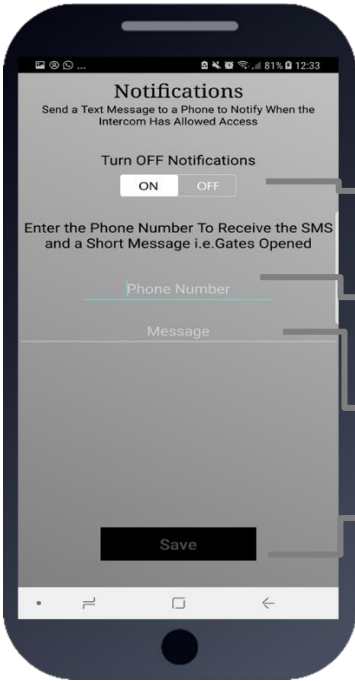

Notifications

ONE PHONE can receive a SMS notification when the intercom triggers the gates.

Turn this feature on and off quickly with this button.

Enter your cell phone number here

Enter a SMS message which will be sent each time the gates are triggered. E.g. "Gates Opened"

Press Save to send SMS (iphone users must also confirm from SMS screen).

Remember only one phone at a time can use this feature.

IMPORTANT: Activating notifications will mute the keypad confirmation tones.

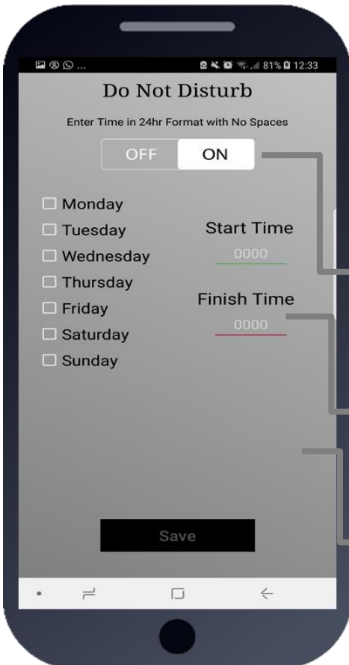

Do Not Disturb

This feature can be used to prevent calls during unsociable hours or at weekends. Simply turn the feature **ON** and then enter **ACTIVE** times which you want the call button to work for. Outside of these times the intercom can still be used for caller ID access or pin codes but the push button will not operate.

Quick turn **ON** or **OFF**. Note: turning **ON** without any times being entered will disable the call button all of the time!

Select the start and finish time for button activity and select the days.

TIP: To have the call button active from 9am to 10pm Monday to Friday, select the 5 days, enter 0900 as a start time, and 2200 as a finish time and press **SAVE**.

After Hours (Out of Hours)

Once the do not disturb is set above, users can program the intercom to call an alternative phone number during do not disturb times rather than call no one. This is used for calling a security guard, site manager, or a different phone outside normal hours.

The screenshot shows a mobile application interface titled "Out Of Hours". At the top, it states "The Intercom Can Call an Alternative Number When the Do Not Disturb Feature is On". Below this, there are two main sections: "Phone Number to Call" and "Button Number". The "Phone Number to Call" section has a text input field with a light blue underline. The "Button Number" section includes instructions: "For Multi-Button Intercoms Enter the Button Number to Call" and "For Single Button Intercom Enter 1". Below these instructions is a text input field containing the number "0". At the bottom of the screen is a black button labeled "Save". Three grey callout boxes with white text and lines pointing to the form elements provide additional instructions: one points to the phone number field, one points to the button number field, and one points to the "Save" button.

Enter the alternative phone number.

Some intercoms have more than one button for multi-family shared gates or doors. Enter the button number here (if in doubt check with your installer before programming this feature).

Press Save to send SMS (iphone users must also confirm from SMS screen).

PHASE 7

Aftercare

Complete list of parameters

For a complete list of programming, SMS parameters check out our downloadable resources on our website.

Troubleshooting

Q. The unit will not power up. No LEDs on.

A. Check power supply voltage at intercom is 23.4v DC or more. Cable length from PSU to intercom should be less than 25 feet and in 14 gauge for longer distances. See guide. Check the fuse.

Q. The unit powers up but is not showing network reception or will not respond to SMS. (No green CPU light).

A. This means the unit is not able to detect the network for some reason.

- Power off the unit, remove the SIM and check it in a mobile phone to verify it can make a call and has calling credit if it is a Pay As You Go SIM.
- Disable any PIN code request if active on the SIM card.
- Check the SIM is a standard voice capable SIM. If you are unsure, contact your SIM card provider to verify.
- Check the reception is medium or good. Poor reception is not sufficient.
- Power off, remove the SIM, use fine sandpaper to lightly sand the SIM pads and try again.
- Check antenna is connected and does not have too many sharp bends on the antenna cable.
- Check the height of the antenna and make sure it is not inside a metal enclosure.
- Check correct power cable size for cable length from PSU. Refer to manual for guidelines

Q. The unit calls the first number, but there is not enough time to answer before it diverts to the next number.

A. Increase the no answer time as per programming instructions.

Q. The unit calls the first number, but voicemail comes on before it can ring the second number.

A. Decrease the no answer time as per programming instructions.

Q. The caller ID function does not work.

A. If your number is private or number withheld, then it will not work.

- Ensure the number is entered as you would normally dial it from another phone.
- For International customers, ensure the numbers have been entered with their international dialling code. If this does not work, try again without.

Q. There is no audio from the gate, but the person at the gate can hear ok.

A. This can be due to low reception or excessively long power cables.

- Check reception level by *20#.
- Change SIM card if necessary, to another network that may have better coverage.
- Purchase a high gain antenna.

This may also be caused by a defective microphone, water on a microphone from a sprinkler for example, or dirt/insects blocking the microphone hole. If reception is optimum and the problem persists, contact your supplier or installer.

Q. The audio quality that can be heard on the remote telephone is poor or humming (buzzing).

A. A small amount of GSM buzz can be considered normal on GSM intercoms, but not so much that causes an inability to hear the person speaking. This is a symptom of poor reception. Try the above steps on checking and improving reception. Consider fitting an external high gain antenna. Move the antenna further away. Remove any short bends in the antenna. Ensure the spare antenna cable is not rolled up inside the call station.

Q. The trigger keys do not work when the intercom calls a phone.

A. Check if you can hear the relay clicking at the gate when the keys are pressed during a call. If it can be heard, then the system is working, check to wire between the relay and the lock or gate panel. If the relays do not make a clicking sound, then check this feature on a different mobile cell phone or landline. If it works on a different phone, check the settings on the phone in question under DTMF tones.

Failure of DTMF tones to operate correctly is also a symptom of low reception or insufficient power cabling. Check the steps above on improving reception or addressing the power problem.

-Also check that the relays are not already latched with the *22# command. If they are latched, they need to be unlatched before the trigger keys will work.

-Sometimes excessively long power cables or thin power cables can cause this problem. Prove it by connecting a temporary extension lead and the power supply directly to the unit.

- Check relay 1 & 2 with multi-meter. If relay 2 works but relay 1 does not, then relay 1 may be defective.

-Check if it works by SMS. Try latching a relay then use the status button to check if the relay is latched. If that works, the problem could be the phone being used, or low signal strength at the intercom.

Q. The system was operating the gates fine, but now it will not trigger the gates.

99% of the time, this is caused by the user accidentally latching the relay. This latches the output relay permanently on. Send the intercom the following SMS *22#. The intercom should reply with a message detailing the relay status. If it has been latched, then the message will state "the relay is ON". In this case, refer to the user guide to read how to unlatch it again.

Q. The unit no longer calls out to phones but I can make a call to it from my phone.

A. Check there is a balance on the SIM card.

A. Switch off the power, remove the SIM, put it into a phone, and check that a call can be made from a phone. This will verify if the SIM is still working and in service.

Q. The Android App shows an error message "Command Failed" when I try to use a function.

A. Go to phone settings/application manager/cellcom prime/permissions, and ensure all permissions are turned ON. Also, ensure the app settings screen has a valid phone number stored.

Q. Homeowner app not working correctly

A. Check the settings on the app that has the intercom SIM number and passcodes entered correctly.

Q. Forgot Engineers code for SMS programming

A. You will need to complete a hard reset by following the steps below.

Note this will erase all data stored on the PCB.

- 1) Power off the unit. (approx 60 secs)
- 2) Link the terminals marked OPEN.
- 3) Switch on the power
- 4) After several seconds the relay will click.
- 5) The unit will then clear memory and be defaulted
- 6) Remove the link and wait around 20 seconds.
- 7) Reboot the unit for good measure

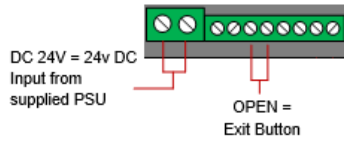

Firmware Updates

Firmware updates will be released to fix any bugs or to add additional features where possible throughout the products lifetime.

The firmware version your system is using can be found by sending the system status message (*20#).



The most recent firmware version will be available via the manufacturer website along with details of any changes made. The updates will need to be loaded on manually using a PC and USB-B cable or a serial connector.

Although most firmware updates are to add or alter features if you find your intercom is on older firmware and are suffering from issues it may be worth following the details below.

****ATTENTION****

PLEASE ENSURE YOU HAVE ALL YOUR DATA BACKED UP IN THE INSTANCE THE DETAILS ARE LOST DURING THIS PROCESS.

This is a precautionary measure as in most cases the data is kept intact after a firmware update.

<p>Upgrade Cable (USB B-type Cable)</p>	<p>Windows Laptop/PC (Windows 10 or later). (USB connection required) (Firmware Burner PC Program, New Firmware File)</p>
	

Step 1: Connect

- (a) Connect USB B-type cable to Windows PC/laptop (Windows 10 or later).
- (b) Connect USB cable to port as shown below. (This can be done while the unit is powered on).

****The intercom will need to be powered on and connected to the cellular network before upgrading can begin****



**** Images are for illustration purposes only. ****

Step 2: Download

- (a) Download the 4G Upgrade Tool from the AES Global website. Found here: <https://www.aesglobalonline.com/gsm-resources>
- (b) Save the zip file to a location of your choice.
- (c) Right click on the zip file and click 'Extract Here'.

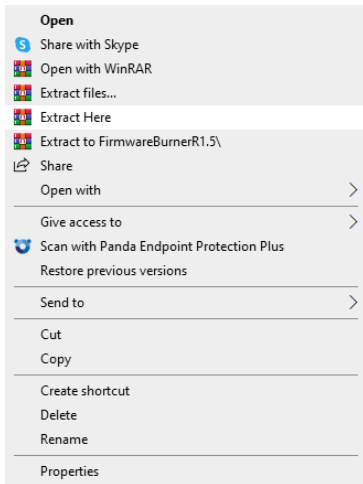

A software to extract the files may be required such as WinZip or 7zip.

- (c) Click on the extracted folder 'FirmwareBurnerR1.5', then the Application file.

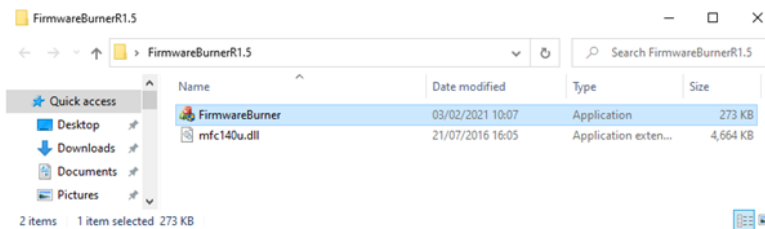

- (d) (Allow the app to 'make changes to your device', when prompted).

Step 3: Upgrade

- (a) 4G Upgrade Tool will load as shown below.
- (b) Enter the 4 digit Programming Passcode (Prime and Snapcom)/ 4 digit Engineers Code (Multicom) and click 'Connect'.
- (c) Check the latest firmware version on the board.
Available to view on most recent firmwares only.
- (d) Click 'Flash', locate the firmware file (bin file format), and wait for the upgrade to complete.
- (e) Close the 4G Upgrade Tool and remove the USB lead from the board.

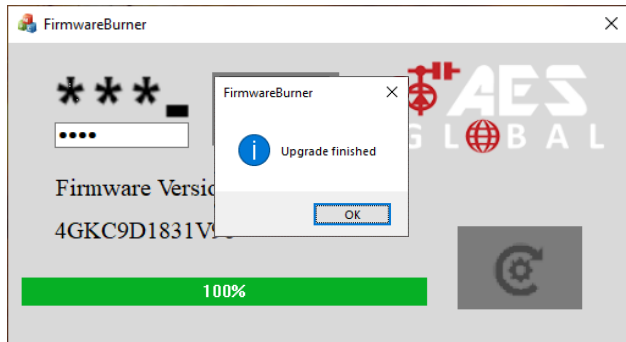
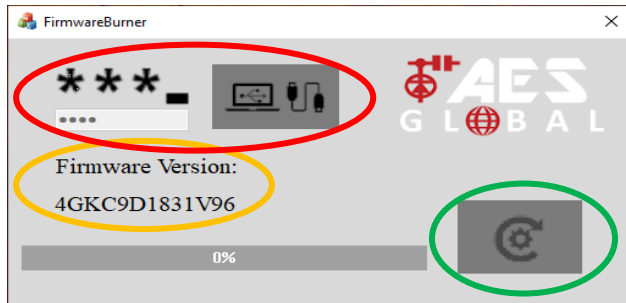

Default Programming Passcode/ Engineers Code is 9999.

Tip: After PCB reconnects to network, reopen Upgrade Tool, Connect and check new firmware version.**

Send the SMS for signal level to the unit to find the firmware version now installed. (*20#)

If you find the data that was previously on the PCB has erased you can recall the data by sending: ***99#**

App Updates

We will continually monitor the app's performance and will release updates to enhance the user's experience and/or fix any issues that arise over time. These updates will be available via the iOS app store or the Android Play store.

Extra Resources

Find all our support resources on our website or scan the QR code below.



EXTRA RESOURCES

www.aesglobalonline.com

Intercom Maintenance

Bug ingress is a common issue in unit failures. Ensure that all components are sealed accordingly and check occasionally. **(Do not open the panel in the rain/snow unless correctly equipped to keep the internals dry. Ensure the unit is securely closed after maintenance)**

If you have an AB, AS, ABK, ASK call point it will have silver edges which are marine grade stainless steel so in normal weather conditions should not rust however it can dull or discolour over time. This can be polished with a suitable stainless-steel cleaner and cloth.

Environmental Information

The equipment that you bought has required the extraction and use of natural resources for its production. It may contain hazardous substances for the environment. To avoid the dissemination of those substances in our environment and to diminish the pressure on natural resources, we encourage you to use the appropriate take-back systems. Those systems will reuse or recycle most of the materials of your end-of-life equipment.

The crossed-bin symbol marked in your device invites you to use those systems.



If you need more information on the collection, reuse and recycling systems, please contact your local or regional waste administration. You can also contact AES Global Ltd for more information on the environmental performances of our products.

Ingress



We recommend sealing all entry holes for prevention of insects that can cause issues with a risk of shorting out components.

To maintain the IP55 rating please follow the sealing instructions included. (also available online)

Documentation Feedback

We are constantly working to produce the highest quality documentation for our products. We welcome your feedback. Send us your comments or suggestions about our online Help, printed, or PDF manuals.

Please include the following information with your feedback:

- Product name and version number
- Type of document: printed manual, PDF, or online Help
- Topic title (for online Help) or page number (for printed or PDF manuals)
- Brief description of content (for example, step-by-step instructions that are inaccurate, information that requires clarification, areas where more detail is needed, and so on)
- Suggestions for how to correct or improve the documentation

We also welcome your suggestions for additional topics you would like to see covered in the documentation.

Send email feedback to: docfeedback@aesglobalonline.com

Please keep in mind that this email address is only for documentation feedback and will not be responded to unless we require more details. If you have a technical question, please contact the technical department.

**LEFT
BLANK**

**LEFT
BLANK**

Warranty

Please note, by installing this product, you are accepting the following warranty terms:

1. The manufacturer's warranty is a "return to base" 2-year warranty from the date of manufacture. This means that any suspected defective components or items are returned to the manufacturer's agent for investigation and diagnosis and returned at the cost of the customer.
2. The warranty does not cover, nor is the manufacturer or agent responsible for any of the following whatsoever: Storm damage, lightning or surge damage, flooding, accidental damage, vandalism or deliberate damage, un-explained corrosion or unusually harsh environments, failure of telephone networks, future un-interoperability between the product and network providers which cause malfunction due to changes implemented by the phone providers after manufacturing of the product, or that which is outside of the control of the manufacturer (e.g. 2G, 3G switch off, removal or inability to obtain VOLTE service), and damage due to not proper installation.
3. The manufacturer in no way accepts liability for any of the following incurred due to a product defect: Cost of attending site, inconveniences, labour rates, time lost, loss to or damage to property, security breaches, late payment clauses or breaches of any contracts between the installer and the client.
4. This is a professional install product only. The product is a component of an overall system. Therefore, it is the responsibility of the installer to certify the safety and compliance of the overall finished system. As soon as this product is fixed to another item, or connected to another third-party device, then the product has been modified, and compliance with local regulations in the country of install is strictly the responsibility of the installer.
5. Re-stocking fees may apply to items returned that are found to be non-defective. Complete units will also attract a re-stocking fee if returned for credit, regardless if a defect is discovered or not. Re-stocking fees may vary depending on the condition of the item being returned, and whether it can be determined as in brand new condition. The warranty terms do not entitle customers to an automatic full refund. For more details on returns procedures and re-stocking fees, contact the agent.
6. Items with physical signs of surge damage are not covered by warranty. Items with visible signs of surge damage will only be covered by warranty if photographic evidence is provided from the site, showing surge protection has been installed.

Full warranty terms and conditions are available upon request to AES Technical Department.

EU-RED Declaration of Conformity

Manufacturer: Advanced Electronic Solutions Global Ltd

Address: Unit 4C, Kilcronagh Business Park, Cookstown, Co Tyrone, BT809HJ, United Kingdom

We/I declare, that the following equipment (Video intercom), part numbers:

WiFi-iBK, WiFi-iB, WiFi-ABK, WiFi-AB, WiFi-BD, WiFi-BEK,

WiFi-BEik, WiFi-Bei, WiFi-BFT-KPAD



Complies with the following essential requirements:

EN 301 489-1 V2.2.0 (2017-03) (Electro-Magnetic compliance)

EN 301-489-17 V3.2.0 (2017-03) (Electro-Magnetic compliance)

EN 62479:2010 (Maximum output power)

EN60950-1:2006+A11:2009+A1:2010+A12:2011+A2:2013 (Electrical Safety)

This product is not complete until fully installed. It is therefore considered a part of an overall system. The installer is responsible to check that the end installation complies with local regulatory requirements. This equipment forms part of a "fixed installation"

NEED MORE ASSISTANCE?

+44 (0)288 639 0693

The manufacturer cannot legally offer technical support to a non-qualified gate or door installers. End users should employ the services of a professional installation company to commission or support this product!

