

# Robot Vacuum Cleaner



# SAFETY WARNING

## PRODUCT SAFETY PRECAUTIONS



Before using this product, please read all the contents of this user manual carefully, install the device accordingly and save this manual for future reference properly. To lower the risk of fire, electric shock or other injuries, please observe the following operation requirements:

- This appliance is not intended for use by people (including children) with reduced physical, sensory or mental capabilities, or lack of experience and knowledge, unless they have been given supervision or instruction concerning use of the appliance by a person responsible for their safety. Children should be supervised to ensure that they do not play with the appliance.
- For European, this appliance can be used by children aged from 8 years and above and people with reduced physical, sensory or mental capabilities or lack of experience and knowledge if they have been given supervision or instruction concerning use of the appliance in a safe way and understand the hazards involved. Cleaning and user maintenance shall not be made by children without supervision. Children should not play with the appliance.
- Please don't suction high-temperature substances (unextinguished cigarette butts, matches, hot ashes and etc.), superfine substances (like lime, cement, sawdust, gesso, ashes and toner), large sharp fragments (not physically definite matters like glass).
- No action needed to shift the product between 50 and 60Hz, product can adapt itself for both 50 and 60Hz.
- If the supply cord is damaged, it must be replaced by the manufacturer, its service agent or similarly qualified persons in order to avoid a hazard.
- When charging, please use the Charging Base CS-RE5-CB offered by EZVIZ.
- **WARNING: To Reduce The Risk Of Electric Shock - Do not use outdoors or on wet surfaces, commercial or industrial environments.**
- **WARNING: To Reduce The Risk Of Electric Shock - Use indoors only.**

- **WARNING:** To Reduce The Risk Of Electric Shock – Unplug Before Servicing.
- The charging base can only charge lithium-ion batteries containing no more than 8 cells with a rated capacity of no more than 2600mAh.
- The charging base can not be charged to non-rechargeable batteries.

## PROPER USE OF THE DEVICE

- The device is only used for cleaning the floor of the home environment, and should not be used in outdoor environment (such as open balconies), non-ground environment (such as stairs), and industrial environment.
- Don't use the device in suspended environment (such as duplexes, open balconies and the top of furniture) without protective facilities.
- Children are not allowed to use the device as a toy. Please keep children and pets away from the device when using it. Don't put accessories such as side brush in the place where children can reach, so as to prevent children from eating by mistake. Don't place children and pets on the device body.
- Don't use the device in an environment with open fire or fragile objects.
- Don't use the device on waterlogged floors or wet ground.
- Don't use the device in an environment higher than 40°C or lower than 0°C.
- Don't use the device to clean any flammable materials (such as gasoline, toner). Don't use the device in the area with flammable materials.
- Don't use the device to clean burning items, such as matches, cigarettes and other items that may cause fire.
- Don't use the product to absorb large stones, waste paper and other items that may block the product. When the suction port is blocked, please clean the product in time and remove the dust, cotton, hair, etc. at the suction port.
- Use only the accessories recommended or sold by the manufacturer. Don't use the batteries or docking station of any third party, and don't use damaged batteries or docking station.
- Dispose of used batteries in accordance with local laws and regulations.

- Don't burn the device under any circumstances, as the battery may cause explosion.
- After the RGB camera is contaminated with dust during use, it is recommended to use the air blower to clean the camera, or use a paper towel and soft dry cloth to wipe and clean, don't use rough or hard materials, so as to avoid scratches on the glass surface of the vision module.
- If the rear surface of the robot is too dusty, it will affect the recharging of the robot. It is recommended to clean it regularly or as needed. It is also recommended to use a paper towel or soft dry cloth to clean it.
- If the surface of the edge sensor on the side of the robot is contaminated with lots of dust, it will affect the posture and mapping positioning effect of the robot when walking along the wall. It is recommended to clean it regularly or as needed. Since the sensor is located inside the body, it is recommended to use the air blowing tool/paper towel/soft dry cloth for cleaning the camera to wipe the sensor. Don't put your fingers into it for cleaning.
- The bottom of the robot is easy to be contaminated with lots of dust, so it is recommended to clean it regularly or as needed.
- Please use the device according to the instructions in the manual. Any loss and injury caused by improper use shall be borne by the user.
- Please don't touch the plug or any electrified part of the product with your wet hands in case of electric shock hazard.
- If you will not use the product for a long time, please turn off the power and unplug the charging plug.

## Regulatory Information



This product and - if applicable - the supplied accessories too are marked with "CE" and comply therefore with the applicable harmonized European standards listed under the EMC Directive 2014/30/EU, the RoHS Directive 2011/65/EU, the ErP Directive 2009/125/EC.



2012/19/EU (WEEE directive): Products marked with this symbol cannot be disposed of as unsorted municipal waste in the European Union. For proper recycling, return this product to your local supplier upon the purchase of equivalent new equipment, or dispose of it at designated collection points. For more information see: [www.recyclethis.info](http://www.recyclethis.info)



2006/66/EC and its amendment 2013/56/EU (battery directive): This product contains a battery that cannot be disposed of as unsorted municipal waste in the European Union. See the product documentation for specific battery information. The battery is marked with this symbol, which may include lettering to indicate cadmium (Cd), lead (Pb), or mercury (Hg). For proper recycling, return the battery to your supplier or to a designated collection point. For more information see: [www.recyclethis.info](http://www.recyclethis.info)

## Technical Parameters

===	Direct current
~	Alternating current
	For indoor use.
	Before charging, read the instructions.

## Robot

<b>Model</b>	CS-RC3-TWT2, CS-RC3-TWT5
<b>Overall Dimension</b>	345×345×78.5 mm
<b>Weight</b>	Approx. 2.83kg
<b>Battery Capacity</b>	2,600 mAh
<b>Battery Rated Voltage</b>	14.4 V
<b>Rated Input</b>	24V === 1A
<b>Rated Power</b>	30W

## Charging Base

<b>Model</b>	CS-RE5-CB
<b>Rated Input Voltage (Power Adapter)</b>	220-240V~, 50/60Hz
<b>Rated Output</b>	24V === 1A

Any and all information, including, among others, wordings, pictures, graphs are the properties of Hangzhou EZVIZ Software Co., Ltd. (hereinafter referred to as “EZVIZ”). This user manual (hereinafter referred to as “the Manual”) cannot be reproduced, changed, translated, or distributed, partially or wholly, by any means, without the prior written permission of EZVIZ. Unless otherwise stipulated, EZVIZ does not make any warranties, guarantees or representations, express or implied, regarding to the Manual.

### **About this Manual**

The Manual includes instructions for using and managing the product. Pictures, charts, images and all other information hereinafter are for description and explanation only. The information contained in the Manual is subject to change, without notice, due to firmware updates or other reasons. Please find the latest version in the EZVIZ™ website (<http://www.ezviz.com>).

### **Revision Record**

New release – January 2023

### **Trademarks Acknowledgement**

EZVIZ™, ™, and other EZVIZ’s trademarks and logos are the properties of EZVIZ in various jurisdictions. Other trademarks and logos mentioned below are the properties of their respective owners.

### **Legal Disclaimer**

TO THE MAXIMUM EXTENT PERMITTED BY APPLICABLE LAW, THE PRODUCT DESCRIBED, WITH ITS HARDWARE, SOFTWARE AND FIRMWARE, IS PROVIDED “AS IS”, WITH ALL FAULTS AND ERRORS, AND EZVIZ MAKES NO WARRANTIES, EXPRESS OR IMPLIED, INCLUDING WITHOUT LIMITATION, MERCHANTABILITY, SATISFACTORY QUALITY, FITNESS FOR A PARTICULAR PURPOSE, AND NON-INFRINGEMENT OF THIRD PARTY. IN NO EVENT WILL EZVIZ, ITS DIRECTORS, OFFICERS, EMPLOYEES, OR AGENTS BE LIABLE TO YOU FOR ANY SPECIAL, CONSEQUENTIAL, INCIDENTAL, OR INDIRECT DAMAGES, INCLUDING, AMONG OTHERS, DAMAGES FOR LOSS OF BUSINESS PROFITS, BUSINESS INTERRUPTION, OR LOSS OF DATA OR DOCUMENTATION, IN CONNECTION WITH THE USE OF THIS PRODUCT, EVEN IF EZVIZ HAS BEEN ADVISED OF THE POSSIBILITY OF SUCH DAMAGES.

TO THE MAXIMUM EXTENT PERMITTED BY APPLICABLE LAW, IN NO EVENT SHALL EZVIZ’S TOTAL LIABILITY FOR ALL DAMAGES EXCEED THE ORIGINAL PURCHASE PRICE OF THE PRODUCT.

EZVIZ DOES NOT UNDERTAKE ANY LIABILITY FOR PERSONAL INJURY OR PROPERTY DAMAGE AS THE RESULT OF PRODUCT INTERRUPTION OR SERVICE TERMINATION CAUSED BY: A) IMPROPER INSTALLATION OR USAGE OTHER THAN AS REQUESTED; B) THE PROTECTION OF NATIONAL OR PUBLIC INTERESTS; C) FORCE MAJEURE; D) YOURSELF OR THE THIRD PARTY, INCLUDING WITHOUT LIMITATION, USING ANY THIRD PARTY’S PRODUCTS, SOFTWARE, APPLICATIONS, AND AMONG OTHERS.

REGARDING TO THE PRODUCT WITH INTERNET ACCESS, THE USE OF PRODUCT SHALL BE WHOLLY AT YOUR OWN RISKS. EZVIZ SHALL NOT TAKE ANY RESPONSIBILITIES FOR ABNORMAL OPERATION, PRIVACY LEAKAGE OR OTHER DAMAGES RESULTING FROM CYBER ATTACK, HACKER ATTACK, VIRUS INSPECTION, OR OTHER INTERNET SECURITY RISKS; HOWEVER, EZVIZ WILL PROVIDE TIMELY TECHNICAL SUPPORT IF REQUIRED. SURVEILLANCE LAWS AND DATA PROTECTION LAWS VARY BY JURISDICTION. PLEASE CHECK ALL RELEVANT LAWS IN YOUR JURISDICTION BEFORE USING THIS PRODUCT IN ORDER TO ENSURE THAT YOUR USE CONFORMS TO THE APPLICABLE LAW. EZVIZ SHALL NOT BE LIABLE IN THE EVENT THAT THIS PRODUCT IS USED WITH ILLEGITIMATE PURPOSES.

IN THE EVENT OF ANY CONFLICTS BETWEEN THE ABOVE AND THE APPLICABLE LAW, THE LATTER PREVAILS.

# Table of Contents

<b>Overview</b> .....	<b>7</b>
Package Contents.....	7
Basis .....	8
<b>Quick Start Guide</b> .....	<b>12</b>
Preparation.....	12
Install the Charging Base.....	12
Connect the Power Supply to the Charging Base .....	13
Place the Robot .....	14
Charging.....	14
Power On/off .....	15
Start Cleaning.....	15
Pause Cleaning.....	16
Sleep .....	16
System Resetting .....	16
<b>Routine Maintenance</b> .....	<b>16</b>
Dump the Dust Box.....	17
Clean the Main Brush.....	18
Clean/Replace the Side Brush.....	19
Clean Universal Wheel .....	20
Clean Sensors .....	20
Clean the Charging Electrode .....	21
<b>Environmental Precautions</b> .....	<b>22</b>
<b>FAQ</b> .....	<b>23</b>
<b>List of Faults</b> .....	<b>25</b>
<b>Appendix</b> .....	<b>26</b>
Rechargeable Lithium ion Battery .....	26
INFORMATION FOR PRIVATE HOUSEHOLDS .....	26

# Overview

## Package Contents



Robot Vacuum Cleaner \*1  
(hereinafter referred as to "Robot")



Charging Base\*1



Side Brush \*2  
(One has pre-installed in the Robot)

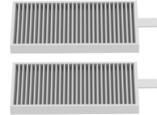

High-performance Filter \*2  
(One has pre-installed in the Robot)



Power Adapter \*1



Cleaning Tool \*1



Remote Control \*1  
(AAA battery \*2 included)



Quick Start Guide \*2







Regulatory Information \*1

- A high-performance filter have been installed in the Robot.
- The device's appearance is subject to the actual one you have bought.

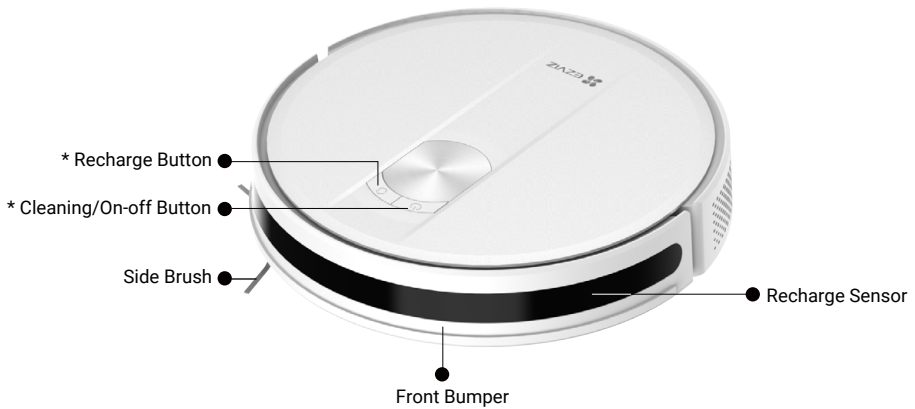

# Basis Robot



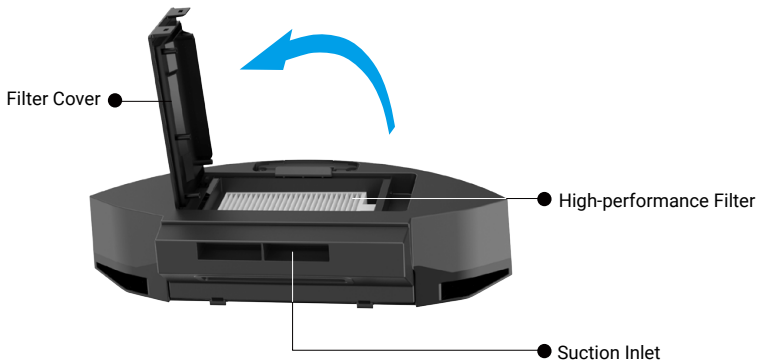
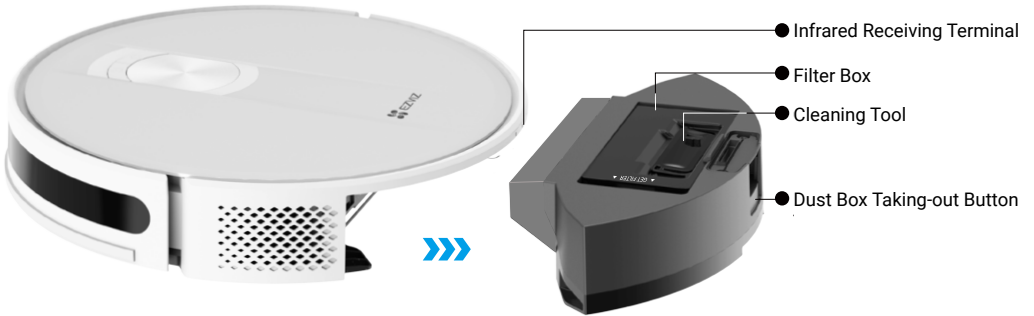
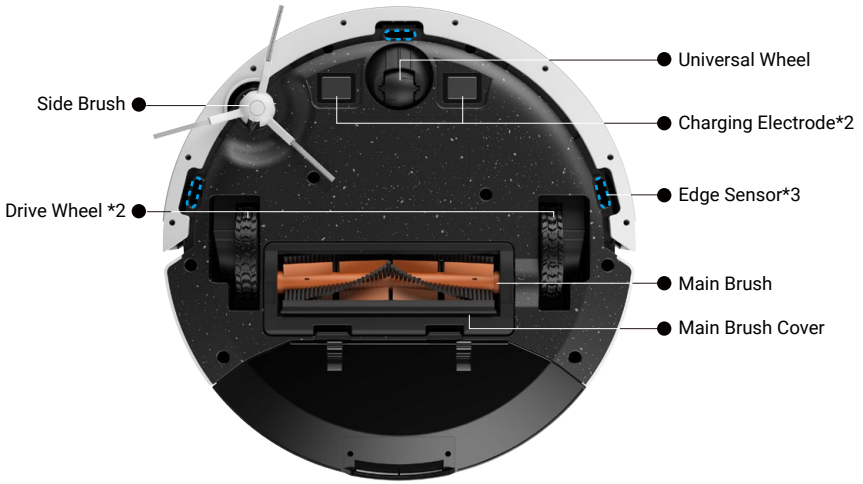

Button		
	Recharge Button	Press once: Back to charge
	Cleaning/On-off Button	<ul style="list-style-type: none"> <li>• Press once: Start cleaning</li> <li>• Press twice: Start fixed-point cleaning</li> <li>• Press and hold for 4s: Turn on/off the Robot</li> </ul>
	Cleaning/On-off Button + Recharge Button	Press and hold for 15s: Restore to factory settings

Power Indicator		
	Power Indicator (on Cleaning/On-off Button & Recharge Button)	<ul style="list-style-type: none"> <li>• White: battery level <math>\geq 20\%</math></li> <li>• Pink: battery level <math>&lt; 20\%</math></li> <li>• Red: fault or exceptions</li> <li>• Slow-flashes white: In charging</li> </ul>

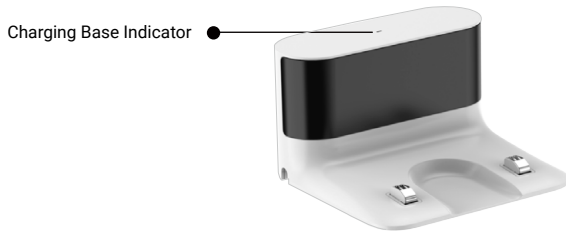

## Charging Base



























Name	Description	
Charging Base Indicator		On: Connected to a power supply
		Off: Powered off/correctly connected with the Charging Base

## Remote Control



Please ensure that the Robot will response with a beep after you operate the remote control.

Name	Description
Power	<p>Press  once when the Robot is standby, it will sleep.</p> <p>* Under the Sleep Mode, the Robot will enter a low energy-consumption state, you can still use the remote control to operate it.</p>
	<p>Press  once when the Robot is operating, it will become standby.</p> <p>* Under the Standby Mode, the Robot will stop the current task.</p>
Sweep At Fixed Points	<p>Press  to enter Fixed-point Cleaning Mode, it will perform vacuum spirally with a 1.5m in diameter around the current Robot location.</p> <p>* Under this mode, the Robot will vacuum with a increasing radius and then a decreasing radius till back to the original starting point.</p>
Recharge	<p>Press  once, enter Recharge Mode.</p>
Start/Pause	<p>Press  once in Standby Mode, enter the Auto-vacuum Mode. (clean in Zigzagging way first and then along the wall)</p>
	<p>Press  once in any clean mode, enter the Standby Mode.</p>
Suction Regulation	<p>Press *  to adjust the suction level.</p> <p>Standard: * Max: </p>
Time Settings	<p>Press  when the Robot is powered on, the time on the display screen will blink, and then you can select the time you want by pressing /.</p>
	<p>Press  or  to switch the time for minute adjustment.</p>
	<p>Press  or  to save your settings.</p>
Sweep Along the Wall	<p>Press  once, enter the Along-wall Clean Mode, the Robot will clean along the wall.</p>
	<p>* After along-wall cleaning is finished, the Robot will enter the Recharge Mode automatically.</p>
Appointment Settings	<p>Press  with the Robot on,  icon and the time on the display screen will blink, and you can press / for hour adjustment.</p>
	<p>Press  or  to switch the time for minute adjustment.</p>
	<p>After settings are completed, press  or  to save it.</p>
	<p>Press and hold  to cancel the appointment settings.</p>

- When controlling the Robot remotely with its Remote Control, stay within the infrared signal range of 7m or the Remote Control may fail.
- When the Recharge Button is pressed, search may fail due to too complicated surrounding obstacles or the exhaustion of the Robot's battery.
- As the infrared ray cannot surpass the wall, please operate the remote control within a visible scope.

# Quick Start Guide

## Preparation

Try to avoid using in the environment with stairs (if must, please set up a guardrail), and try to remove the obstacles on the ground before use.

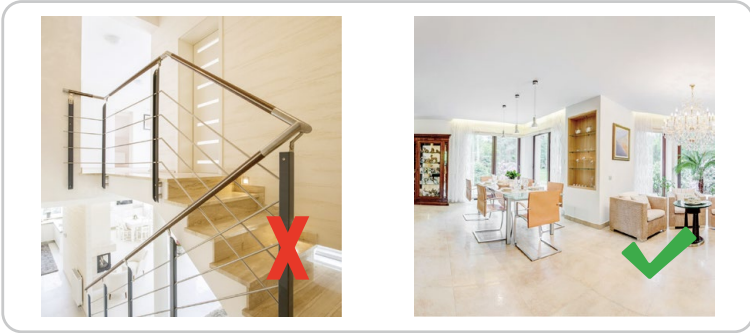

## Install the Charging Base

Connect the supply cord into the power socket on the Charging Base. Please be careful to organize the supply cord.

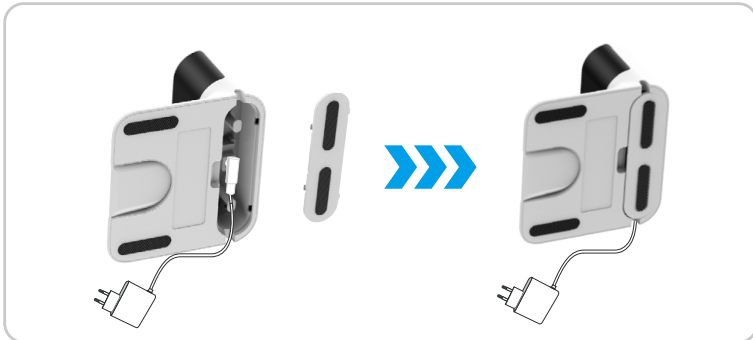

## Connect the Power Supply to the Charging Base

Install the Charging Base in a location that the Robot can easily access. It is recommended to place the Charging Base against a wall, and on a hard-level surface rather than on rugs or carpets.

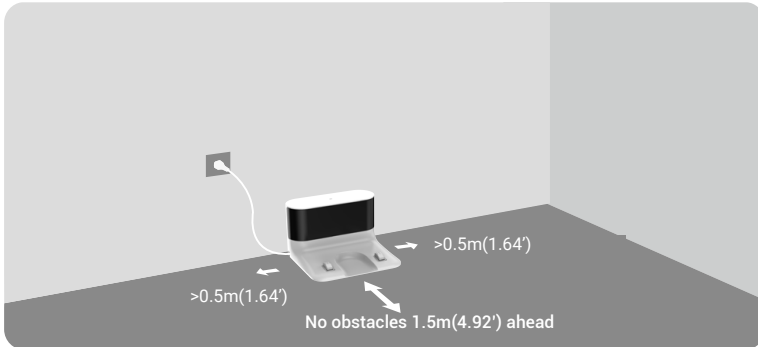

- In order to avoid external heat damage to the Charging Base, please do not place it next to radiators, heaters, fireplaces, etc.
- Keep the Charging Base powered, or the Robot will not automatically returned.
- For a normal charging process, please do not place the Charging Base in environments subjected to direct sunlight, rain, snow or humidity

## Remove Shields

Before use, remove the shields on both sides of the Front Bumper and all protective films on both of the Robot and the Charging Base.



## Place the Robot

Place the Robot on the Charging Base and align it with the Charging Electrodes. When the charging base indicator on the Charging Base goes out and the power indicator slow-flashes, charging will begin.





## Charging

You have two ways to charge the Robot.

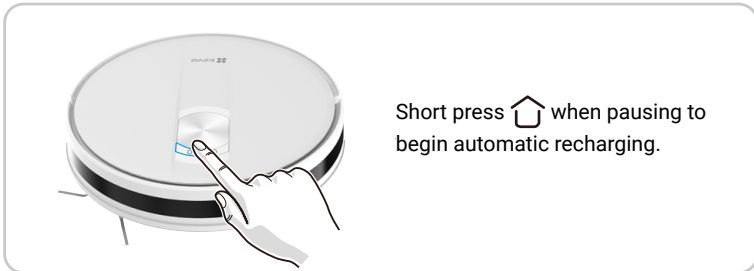

Automatic recharging: the Robot will automatically return for recharging after the cleaning task is completed.

Manual recharging:



-  • The Robot needs to be fully charged (approximately 5 hours) to ensure a normal operation.
- If the Robot is stucked or cannot find the Charging Base, please manually put the Robot back to the the Charging Base.

## Power On/off

- Power on:
- Press and hold the  button for 4s on the operation panel.
  - After the Robot is docking to the Charging Base, it will be powered on automatically.
- Power off:
- When the Robot is not in the Charging Base, press and hold the  button for 4s on the operation panel.
-  After power the Robot off, you cannot use the remote control to operate it.



## Start Cleaning

Short press the  button to start the Full-house Cleaning Mode. Recommended start the Full-house Cleaning Mode when the Robot is on the Charging Base. The Robot will leave the Charging Base and clean in Zigzagging way, and then clean the area along the wall.

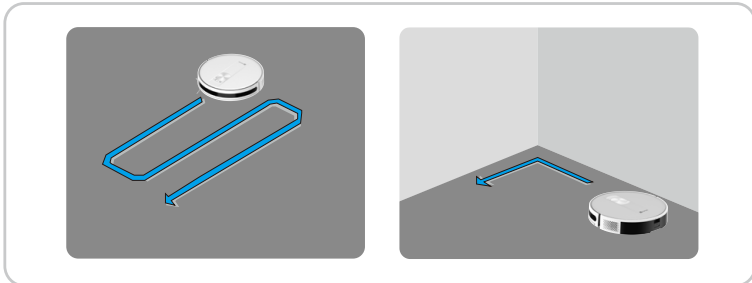

-  • If the battery level is too low to start cleaning, please charge it first.
- Do not move the Charging Base during cleaning, and make sure that the Charging Base is powered on, otherwise the Robot may not be able to return for charging.



## Pause Cleaning

Pressing  will pause the Robot while cleaning.

Pressing  will stop the Robot while cleaning.

## Sleep



Automatically switch to Sleep Mode:

- The Robot is inactive and the Charging Base is not connected for 10 minutes.
- There is no operation within 10 minutes after the Robot is fully charged.

Manually switch to Sleep Mode:

Press the  button on remote control.

## System Resetting

In Standby Mode, press and hold the  +  button for 15s to reset the system.

After resetting the system, the Robot will restore to factory settings.

## Routine Maintenance

To maintain the best condition of the Robot, please maintain the Robot and replace parts with following frequencies:

Robot Part	Maintenance Frequency	Replacement Frequency
Side Brush	Once every 2 weeks	Every 3-6 months
Main Brush	Once per week	Every 6-12 months
High-performance Filter	Once per week	Every 3-6 months
Edge Sensor Recharge Sensor Cliff Sensor Infrared Receiving Terminal Front Bumper Charging Electrode Universal Wheel/Drive Wheel	Once per week	/

- Before performing cleaning and maintenance tasks on the Robot, turn the Robot OFF and unplug the supply cord.
- A multi-function Cleaning Tool is provided for easy maintenance. Handle with care, this Cleaning Tool has sharp edges.
- EZVIZ manufactures various replacement parts and fittings. Please visit [www.ezviz.com](http://www.ezviz.com) for more information on replacement parts.

# Dump the Dust Box

Press the Dust Box Taking-out Button to pull out the Dust Box, and then pour the dirt into dust bin.



Remove the Filter out of the filter box.



Clean the Filter with Cleaning Tool and flush the Filter and Dust Box thoroughly with water as necessary, and then all cleaned elements shall be thoroughly dried.

- 1 Do not clean with hot water or detergent.

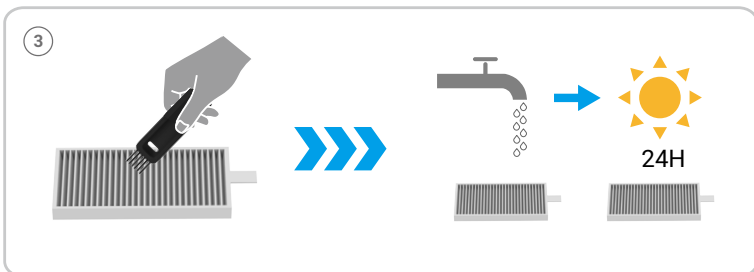

# Clean the Main Brush

Press the buckles to take out the Main Brush cover and the Main Brush.



Use the blade of the Cleaning Tool to cut off the hair entangled on the Main Brush and remove the roller at one end of the Main Brush to clean it, and then re-install the Main Brush into place.

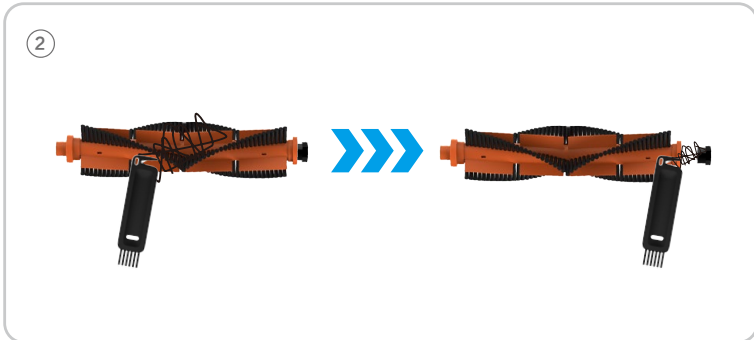

## Clean/Replace the Side Brush

Pull the side brush out and then clean the foreign matters like hairs.

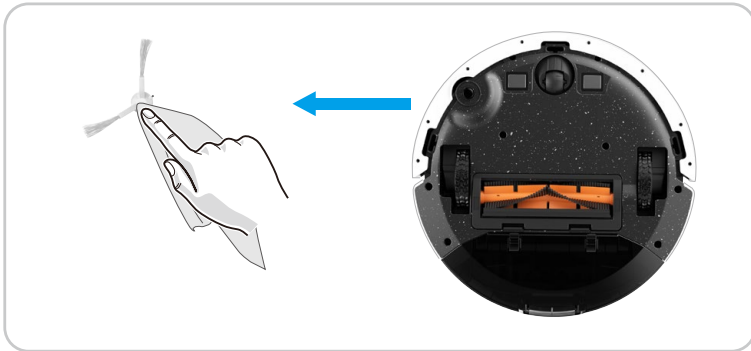

Pull out the old side brush and then press the new one into the position.

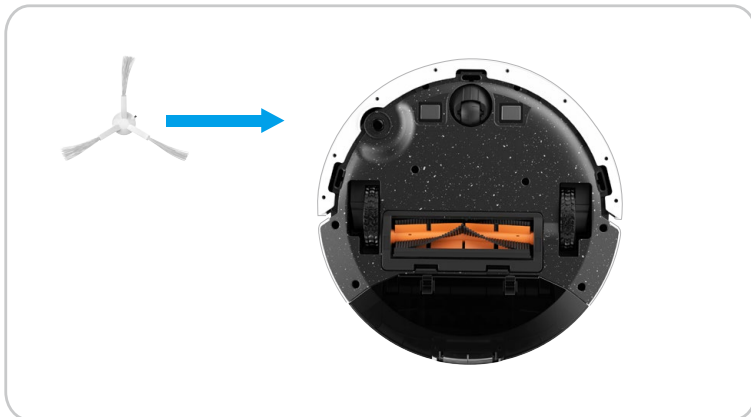

## Clean Universal Wheel

- ① Pull up the Universal Wheel directly by hand then clean it with the hidden Cleaning Tool and then re-install it into place.
- ② Clean the Universal Wheel with the hidden Cleaning Tool.

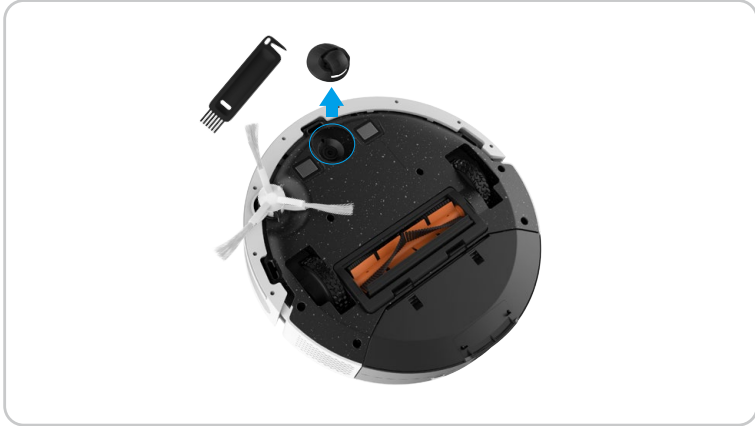

## Clean Sensors

Wipe dust off from the sensors with a soft dry cloth.

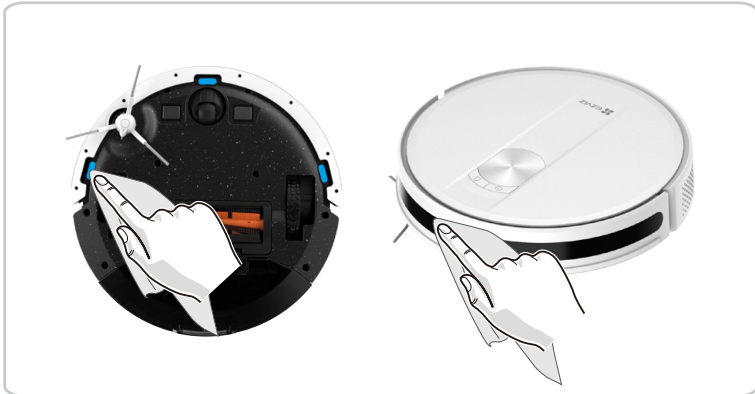

# Clean the Charging Electrode

Wipe off the dust on the Charging Electrodes with a soft dry cloth.

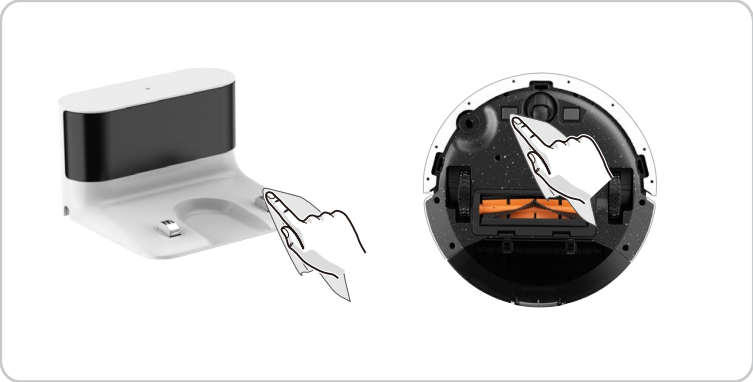

# Environmental Precautions

The chemical substances contained in the built-in lithium-ion battery of this product may cause environmental pollution. Please remove it before scrapping and send it to a professional battery recycling station for centralized disposal.

Steps for removing the battery (the following information is only applicable when discarding the device, not the daily operation instructions):

1. Let the Robot run to a low power state that cannot be cleaned without touching the Charging Base.
2. Turn off the Robot and remove the Side Brush and Dust Box.
3. Turn the Robot over and remove the screws at the bottom.
4. Remove the battery cover.
5. Take out the battery.

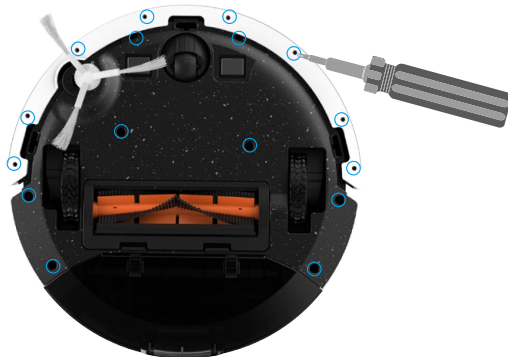

- When disassembling the battery, please ensure that the power is exhausted and operate with the Charging Base disconnected.
- Please disassemble the whole battery pack together and do not damage the battery pack casing to avoid short circuit or leakage of hazardous substances.
- If the battery has exudate and accidentally touches it, please flush it with plenty of water and seek medical attention promptly.
- This product should not be discarded after the expiration date or after the repair cannot work normally, please hand it over to an enterprise qualified to dispose of WEEE, please refer to the national or local regulations on the disposal of WEEE for the correct method.

# FAQ

The power indicator will flash in red and the buzzer will give a beep in case that there is an abnormality in the operation of the Robot. Please check the table below to solve your problems.

Problem	Solution
The Robot cannot start	Make sure the Robot is connected to power supply.
	Make sure the battery is fully charged.
	If the problem persists, please reset the Robot.
The Robot suddenly stops working.	Check whether the Robot is stuck or blocked by obstacles.
	Check whether the battery is too low.
	If the problem persists, please shut it down, wait for 3 seconds, and then restart it.
Cannot make a sweep schedule	Make sure the Robot has been powered on.
	Make sure the schedule time has been set correctly.
	Check whether the Robot power is too low to start sweep.
	Set the remote control time and scheduled time failed. Please try to adjust the time of the Robot and scheduled time and make sure the settings are effective.
	The Robot will not start any scheduled cleaning when the task is being performed.
Suction too weak	Check the suction inlet for any obstruction.
	Empty the Dust Box.
	Clean Filters with water.
	Check whether Filters are wet due to water or other liquids on the floor. Let Filters dry naturally thoroughly before use.
Cannot charge the Robot	Please check whether the Charging Base is correctly connected to the power supply, and the charging base indicator light illuminates when the power is on.
	When the Robot is normally connected to the Charging Base, the charging base indicator light extinguishes.
	If the Robot is connected to the Charging Base, but the charging base indicator light does not extinguish and the Robot does not respond, please use a dry cloth to wipe the Charging Electrodes at the bottom of the Robot and the Charging Electrodes of the Charging Base, and then try again.
	If the Robot still can not be charged after performing the above operations, please contact the after-sales department or your dealer.





Problem	Solution
The Robot cannot return to the Charging Base.	Clear the Charging Base of objects within 0.5m on the left and right sides and within 1.5m ahead.
	Make sure that the Robot starts sweep from the Charging Base without abnormal movement.
	When the Robot is near the Charging Base, it can return faster. But if the Charging Base is located far away, the Robot will need more time to return.
	Please wait during its return.
	Clean Charging Electrodes.
The Main Brush does not rotate	Clean the Main Brush.
	Check whether the Main Brush and the Main Brush cover are installed correctly.
Abnormal action or sweep route of the Robot	Carefully clean the Sensor with a dry cloth.
	Restart the Robot.
The Robot cannot be controlled accurately by your Remote Control	Check whether the Remote Control has enough power. If the screen can not light up, please replace two new AAA batteries.
	Check whether the Robot has enough power. If the Robot can not be powered on after press and hold the (⏻) Button for 4s, please put the Robot back to Charging Base manually and try again after the Robot is fully charged.
	The Remote Control works with infrared rays and the infrared receiving terminal of the Robot is located on the front of it. Please aimed at the front of the Robot for remote control operations.

 For additional information about the Robot, please refer to [www.ezviz.com/eu](http://www.ezviz.com/eu).

# List of Faults

The power indicator will flash in red and the buzzer will give a beep in case that there is an abnormality in the operation of the Robot. Please check the table below to solve your problems.

Voice Prompts	Solutions
"Beeb" "Beeb" "Beeb" (Beeb 3 times continuously, interval 2s, repeat 10 times)	Side Brush module abnormal • Please check whether any foreign matter is stuck in a Side Brush and try to restart the Robot. • If the error persists, please contact our Service Department.
"Beeb" (Interval 2s, repeat 10 times)	Rolling Brush abnormal • Please remove and clean it, its connections, its Cover and the Suction Inlet. • Please try to restart the Robot after cleaning. • If the error persists, please contact our Service Department.
"Beeb" "Beeb" "Beeb" "Beeb" (Beeb 4 times continuously, interval 2s, repeat 10 times)	Abnormal charging Please check the charging area for contamination and try to clean the Charging Electrodes.  Wheel module abnormal • Please check whether any foreign matter is stuck in a wheel and try to restart the Robot. • If the error persists, please contact our Service Department.
"Beeb" "Beeb" "Beeb"—"Beeb" "Beeb" (Beeb 3 times first and then beeb twice continuously, interval 2s, repeat 10 times)	Fan abnormal • Please check whether any foreign matter is stuck in the fan and try to restart the Robot. • Please clean the Dust Box and filters and try to restart the Robot. • If the error persists, please contact our Service Department.
"Beeb" "Beeb" "Beeb" "Beeb" — "Beeb" "Beeb" "Beeb" (Beeb 4 times first and then beeb 3 times continuously, interval 2s, repeat 10 times)	Battery abnormal • The battery temperature is too high or too low. Please wait for the battery temperature to be normal (0°C~40°C/32°F~104°F) before use. • If the error persists, please contact our Service Department.

If the corresponding faults cannot be eliminated by referring to the above methods, please press and hold  and  for 15s, and the Robot will restore to factory settings automatically. If still not eliminated, please refer to [www.ezviz.com/eu](http://www.ezviz.com/eu).

## Rechargeable Lithium ion Battery

1. The battery type of the Robot: Portable battery.
2. The battery of this Robot is non-removable, which is risky to remove.

Chemical Composition	Chemical Formula	CAS No.	Weight (%)
Lithium transition metal oxide <sup>(2)</sup>	Li <sub>x</sub> MO <sub>2</sub>	182442-95-1	37.3%
Carbon(graphite)	C	7782-42-5	21.0%
Aluminum	Al	7429-90-5	3.27%
Copper	Cu	7440-50-8	7.69%
Steel can	Fe	7439-89-6	13.53%
Electrolyte	C <sub>3</sub> H <sub>4</sub> O <sub>3</sub>	96-49-1	10.67%
	C <sub>4</sub> H <sub>6</sub> O <sub>3</sub>	623-53-0	
	C <sub>3</sub> H <sub>6</sub> O <sub>3</sub>	616-38-6	
	F <sub>6</sub> LiP	21324-40-3	
Others		proprietary	6.54%

## INFORMATION FOR PRIVATE HOUSEHOLDS

1. Separate collection of waste equipment: Electrical and electronic equipment that has become waste is referred to as waste equipment. Owners of waste equipment must dispose of it separately from unsorted municipal waste. In particular, waste equipment does not belong in household waste, but in special collection and return systems.

2. Batteries and rechargeable batteries as well as lamps: Owners of waste equipment shall, as a rule, separate waste batteries and rechargeable batteries that are not enclosed in the waste equipment, which can be removed from the waste equipment without being destroyed, from the waste equipment before handing them in at a collection point. This does not apply if waste equipment is prepared for reuse with the participation of a public waste management authority.

3. Options for returning waste equipment: Owners of waste equipment from private households can return it free of charge to the collection points of the public waste management authorities or to the take-back points set up by manufacturers or distributors within the meaning of the Electrical and Electronics Equipment Law. Stores with a sales area of at least 400 m<sup>2</sup> for electrical and electronic equipment and those grocery stores with a total sales area of at least 800 m<sup>2</sup> that offer electrical and electronic equipment several times a year or on a permanent basis and make it available in the market are required to take it back. This also applies in the case of distribution using means of distance communication, if the storage and shipping areas for electrical and electronic equipment are at least 400 m<sup>2</sup> or the total storage and shipping areas are at least 800 m<sup>2</sup>. Distributors shall, in principle, ensure take-back by providing suitable return facilities at a reasonable distance from the respective end user. The possibility of returning waste equipment free of charge exists for distributors who are obliged to take it back, among other things, if a new similar device that essentially fulfills the same functions is delivered to an end user.

4. Privacy Notice: Waste equipment often contains sensitive personal data. This applies in particular to devices of information and telecommunications technology such as computers and smartphones. In your own interest, please note that each end user is responsible for deleting the data on the waste equipment to be disposed of.

5. Meaning of the symbol "crossed-out wheelee bin": The symbol of a crossed-out wheelee bin regularly depicted on electrical and electronic equipment indicates that the respective device is to be collected separately from unsorted municipal waste at the end of its service life.