

# Robot Vacuum Cleaner



# SAFETY WARNING

## PRODUCT SAFETY PRECAUTIONS



Before using this product, please read all the contents of this user manual carefully, install the device accordingly and save this manual for future reference properly. To lower the risk of fire, electric shock or other injuries, please observe the following operation requirements:

- This appliance is not intended for use by people (including children) with reduced physical, sensory or mental capabilities, or lack of experience and knowledge, unless they have been given supervision or instruction concerning use of the appliance by a person responsible for their safety. Children should be supervised to ensure that they do not play with the appliance.
- For European, this appliance can be used by children aged from 8 years and above and people with reduced physical, sensory or mental capabilities or lack of experience and knowledge if they have been given supervision or instruction concerning use of the appliance in a safe way and understand the hazards involved. Cleaning and user maintenance shall not be made by children without supervision. Children should not play with the appliance.
- Please don't suction high-temperature substances (unextinguished cigarette butts, matches, hot ashes and etc.), superfine substances (like lime, cement, sawdust, gesso, ashes and toner), large sharp fragments (not physically definite matters like glass).
- No action needed to shift the product between 50 and 60Hz, product can adapt itself for both 50 and 60Hz.
- If the supply cord is damaged, it must be replaced by the manufacturer, its service agent or similarly qualified persons in order to avoid a hazard.
- When charging, please use the Auto-empty Base ZD21 offered by EZVIZ.
- **WARNING: To Reduce The Risk Of Electric Shock - Do not use outdoors or on wet surfaces, commercial or industrial environments.**
- **WARNING: To Reduce The Risk Of Electric Shock - Use indoors only.**
- **WARNING: To Reduce The Risk Of Electric Shock – Unplug**

Before Servicing.

- The auto-empty base can only charge lithium-ion batteries containing no more than 8 cells with a rated capacity of no more than 2600mAh.
- The auto-empty base can not be charged to non-rechargeable batteries.

## PROPER USE OF THE DEVICE

- The device is only used for cleaning the floor of the home environment, and should not be used in outdoor environment (such as open balconies), non-ground environment (such as stairs), and industrial environment.
- Don't use the device in suspended environment (such as duplexes, open balconies and the top of furniture) without protective facilities.
- Children are not allowed to use the device as a toy. Please keep children and pets away from the device when using it. Don't put accessories such as side brush in the place where children can reach, so as to prevent children from eating by mistake. Don't place children and pets on the device body.
- Don't use the device in an environment with open fire or fragile objects.
- Don't use the device on waterlogged floors or wet ground.
- Don't use the device in an environment higher than 40°C or lower than 0°C.
- Don't use the device to clean any flammable materials (such as gasoline, toner). Don't use the device in the area with flammable materials.
- Don't use the device to clean burning items, such as matches, cigarettes and other items that may cause fire.
- Don't use the product to absorb large stones, waste paper and other items that may block the product. When the suction port is blocked, please clean the product in time and remove the dust, cotton, hair, etc. at the suction port.
- Use only the accessories recommended or sold by the manufacturer. Don't use the batteries or docking station of any third party, and don't use damaged batteries or docking station.
- Dispose of used batteries in accordance with local laws and regulations.
- Don't burn the device under any circumstances, as the battery may

cause explosion.

- After the RGB camera is contaminated with dust during use, it is recommended to use the air blower to clean the camera, or use a paper towel and soft dry cloth to wipe and clean, don't use rough or hard materials, so as to avoid scratches on the glass surface of the vision module.
- If the rear surface of the robot is too dusty, it will affect the recharging of the robot. It is recommended to clean it regularly or as needed. It is also recommended to use a paper towel or soft dry cloth to clean it.
- If the surface of the edge sensor on the side of the robot is contaminated with lots of dust, it will affect the posture and mapping positioning effect of the robot when walking along the wall. It is recommended to clean it regularly or as needed. Since the sensor is located inside the body, it is recommended to use the air blowing tool/paper towel/soft dry cloth for cleaning the camera to wipe the sensor. Don't put your fingers into it for cleaning.
- The bottom of the robot is easy to be contaminated with lots of dust, so it is recommended to clean it regularly or as needed.
- Please use the device according to the instructions in the manual. Any loss and injury caused by improper use shall be borne by the user.
- Please don't touch the plug or any electrified part of the product with your wet hands in case of electric shock hazard.
- If you will not use the product for a long time, please turn off the power and unplug the charging plug.

## Regulatory Information



This product and - if applicable - the supplied accessories too are marked with "CE" and comply therefore with the applicable harmonized European standards listed under the EMC Directive 2014/30/EU, the RoHS Directive 2011/65/EU, the ErP Directive 2009/125/EC, the LVD Directive 2014/35/EU.



2012/19/EU (WEEE directive): Products marked with this symbol cannot be disposed of as unsorted municipal waste in the European Union. For proper recycling, return this product to your local supplier upon the purchase of equivalent new equipment, or dispose of it at designated collection points. For more information see: [www.recyclethis.info](http://www.recyclethis.info)



2006/66/EC and its amendment 2013/56/EU (battery directive): This product contains a battery that cannot be disposed of as unsorted municipal waste in the European Union. See the product documentation for specific battery information. The battery is marked with this symbol, which may include lettering to indicate cadmium (Cd), lead (Pb), or mercury (Hg). For proper recycling, return the battery to your supplier or to a designated collection point. For more information see: [www.recyclethis.info](http://www.recyclethis.info)

## Technical Parameters

	Class II
	Direct current
	Alternating current
	For indoor use.
	Before charging, read the instructions.

## Robot

<b>Model</b>	CS-RC3P-TWT2, CS-RC3P-TWT5
<b>Overall Dimension</b>	345×345×78.5 mm
<b>Weight</b>	Approx. 2.83kg
<b>Battery Capacity</b>	2,600 mAh
<b>Battery Rated Voltage</b>	14.4 V
<b>Rated Input</b>	24V  1.5A
<b>Rated Power</b>	30W

## Auto-empty Base

<b>Model</b>	ZD21
<b>Dimensions</b>	220×180×380 mm
<b>Rated Power</b>	950W
<b>Rated Output</b>	24V  1.5A MAX
<b>Rated Voltage</b>	220-240V~, 50/60Hz

Any and all information, including, among others, wordings, pictures, graphs are the properties of Hangzhou EZVIZ Software Co., Ltd. (hereinafter referred to as “EZVIZ”). This user manual (hereinafter referred to as “the Manual”) cannot be reproduced, changed, translated, or distributed, partially or wholly, by any means, without the prior written permission of EZVIZ. Unless otherwise stipulated, EZVIZ does not make any warranties, guarantees or representations, express or implied, regarding to the Manual.

### **About this Manual**

The Manual includes instructions for using and managing the product. Pictures, charts, images and all other information hereinafter are for description and explanation only. The information contained in the Manual is subject to change, without notice, due to firmware updates or other reasons. Please find the latest version in the EZVIZ™ website (<http://www.ezviz.com>).

### **Revision Record**

New release – January 2023

### **Trademarks Acknowledgement**

EZVIZ™, ™, and other EZVIZ’s trademarks and logos are the properties of EZVIZ in various jurisdictions. Other trademarks and logos mentioned below are the properties of their respective owners.

### **Legal Disclaimer**

TO THE MAXIMUM EXTENT PERMITTED BY APPLICABLE LAW, THE PRODUCT DESCRIBED, WITH ITS HARDWARE, SOFTWARE AND FIRMWARE, IS PROVIDED “AS IS”, WITH ALL FAULTS AND ERRORS, AND EZVIZ MAKES NO WARRANTIES, EXPRESS OR IMPLIED, INCLUDING WITHOUT LIMITATION, MERCHANTABILITY, SATISFACTORY QUALITY, FITNESS FOR A PARTICULAR PURPOSE, AND NON-INFRINGEMENT OF THIRD PARTY. IN NO EVENT WILL EZVIZ, ITS DIRECTORS, OFFICERS, EMPLOYEES, OR AGENTS BE LIABLE TO YOU FOR ANY SPECIAL, CONSEQUENTIAL, INCIDENTAL, OR INDIRECT DAMAGES, INCLUDING, AMONG OTHERS, DAMAGES FOR LOSS OF BUSINESS PROFITS, BUSINESS INTERRUPTION, OR LOSS OF DATA OR DOCUMENTATION, IN CONNECTION WITH THE USE OF THIS PRODUCT, EVEN IF EZVIZ HAS BEEN ADVISED OF THE POSSIBILITY OF SUCH DAMAGES.

TO THE MAXIMUM EXTENT PERMITTED BY APPLICABLE LAW, IN NO EVENT SHALL EZVIZ’S TOTAL LIABILITY FOR ALL DAMAGES EXCEED THE ORIGINAL PURCHASE PRICE OF THE PRODUCT.

EZVIZ DOES NOT UNDERTAKE ANY LIABILITY FOR PERSONAL INJURY OR PROPERTY DAMAGE AS THE RESULT OF PRODUCT INTERRUPTION OR SERVICE TERMINATION CAUSED BY: A) IMPROPER INSTALLATION OR USAGE OTHER THAN AS REQUESTED; B) THE PROTECTION OF NATIONAL OR PUBLIC INTERESTS; C) FORCE MAJEURE; D) YOURSELF OR THE THIRD PARTY, INCLUDING WITHOUT LIMITATION, USING ANY THIRD PARTY’S PRODUCTS, SOFTWARE, APPLICATIONS, AND AMONG OTHERS.

REGARDING TO THE PRODUCT WITH INTERNET ACCESS, THE USE OF PRODUCT SHALL BE WHOLLY AT YOUR OWN RISKS. EZVIZ SHALL NOT TAKE ANY RESPONSIBILITIES FOR ABNORMAL OPERATION, PRIVACY LEAKAGE OR OTHER DAMAGES RESULTING FROM CYBER ATTACK, HACKER ATTACK, VIRUS INSPECTION, OR OTHER INTERNET SECURITY RISKS; HOWEVER, EZVIZ WILL PROVIDE TIMELY TECHNICAL SUPPORT IF REQUIRED. SURVEILLANCE LAWS AND DATA PROTECTION LAWS VARY BY JURISDICTION. PLEASE CHECK ALL RELEVANT LAWS IN YOUR JURISDICTION BEFORE USING THIS PRODUCT IN ORDER TO ENSURE THAT YOUR USE CONFORMS TO THE APPLICABLE LAW. EZVIZ SHALL NOT BE LIABLE IN THE EVENT THAT THIS PRODUCT IS USED WITH ILLEGITIMATE PURPOSES.

IN THE EVENT OF ANY CONFLICTS BETWEEN THE ABOVE AND THE APPLICABLE LAW, THE LATTER PREVAILS.

# Table of Contents

<b>Overview</b> .....	<b>7</b>
Package Contents.....	7
Basis .....	8
Robot .....	8
Auto-empty Base.....	9
<b>Quick Start Guide</b> .....	<b>12</b>
Preparation.....	12
Connect the Power Supply to the Auto-empty Base.....	12
Remove Shields.....	13
Place the Robot .....	13
Charging.....	14
Power On/off .....	14
Start Cleaning.....	15
Pause Cleaning.....	15
Sleep .....	15
System Resetting .....	15
<b>Routine Maintenance</b> .....	<b>16</b>
Dump the Dust Box.....	17
Clean the Main Brush.....	18
Clean/Replace the Side Brush.....	19
Clean Universal Wheel .....	20
Clean Sensor .....	20
Clean the Charging Electrode .....	21
Replace the Dust Bag.....	21
Clean the Dust Channel.....	22
<b>Environmental Precautions</b> .....	<b>23</b>
<b>FAQ</b> .....	<b>24</b>
<b>List of Faults</b> .....	<b>27</b>
<b>Appendix</b> .....	<b>28</b>
Rechargeable Lithium ion Battery .....	28
INFORMATION FOR PRIVATE HOUSEHOLDS .....	28

# Overview

## Package Contents



Robot Vacuum Cleaner \*1  
(hereinafter referred to as "Robot")



Auto-empty Base \*1



Side Brush \*2  
(One has pre-installed in the Robot)

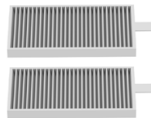

High-performance Filter \*2  
(One has pre-installed in the Robot)

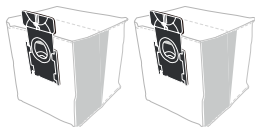

Disposable Dust Bag \*2  
(One has pre-installed)



Cleaning Tool \*1



Remote Control \*1  
(AAA battery \*2 included)



Quick Start Guide \*2



Regulatory Information \*1

- 1 • A high-performance filter have been installed in the robot.
- The device's appearance is subject to the actual one you have bought.



# Basis

## Robot

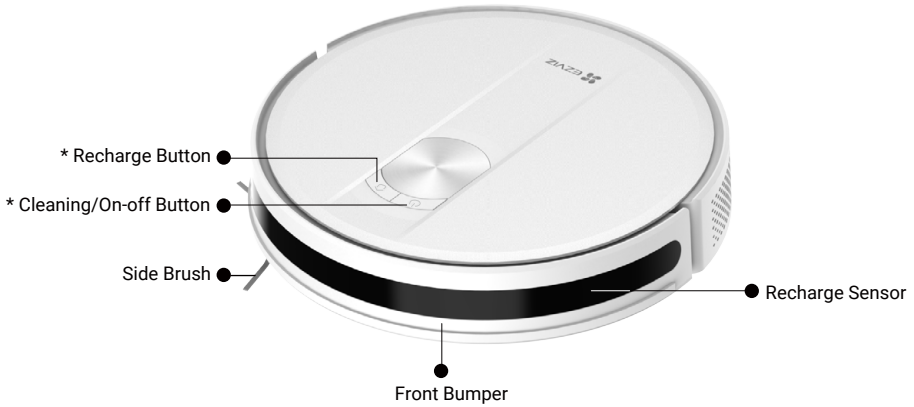

Button		
	Recharge Button	Press once: back to charging
	Cleaning/On-off Button	<ul style="list-style-type: none"> <li>Press once: start cleaning</li> <li>Press twice: start fixed-point cleaning</li> <li>Press and hold for 4 seconds: turn on/off the Robot</li> </ul>
	Cleaning/On-off Button + Recharge Button	Press and hold for 15s: restore to factory settings



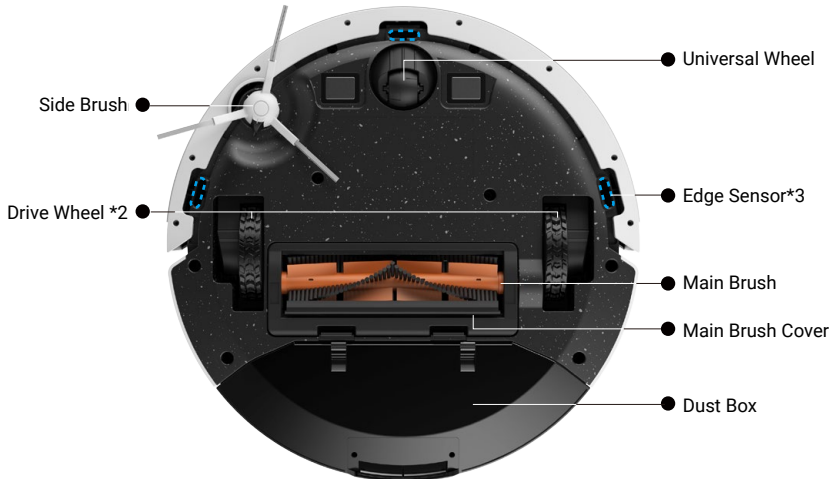

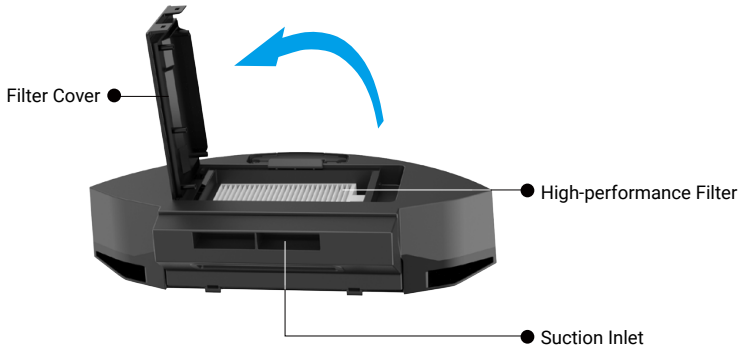
Power Indicator			
	<table border="0"> <tr> <td>Power Indicator (on Cleaning/On-off Button &amp; Recharge Button)</td> <td> <ul style="list-style-type: none"> <li>White: battery level <math>\geq 20\%</math></li> <li>Pink: battery level <math>&lt; 20\%</math></li> <li>Red: fault or exceptions</li> <li>Slow-flashes white: In charging</li> </ul> </td> </tr> </table>	Power Indicator (on Cleaning/On-off Button & Recharge Button)	<ul style="list-style-type: none"> <li>White: battery level <math>\geq 20\%</math></li> <li>Pink: battery level <math>&lt; 20\%</math></li> <li>Red: fault or exceptions</li> <li>Slow-flashes white: In charging</li> </ul>
Power Indicator (on Cleaning/On-off Button & Recharge Button)	<ul style="list-style-type: none"> <li>White: battery level <math>\geq 20\%</math></li> <li>Pink: battery level <math>&lt; 20\%</math></li> <li>Red: fault or exceptions</li> <li>Slow-flashes white: In charging</li> </ul>		





### Auto-empty Base





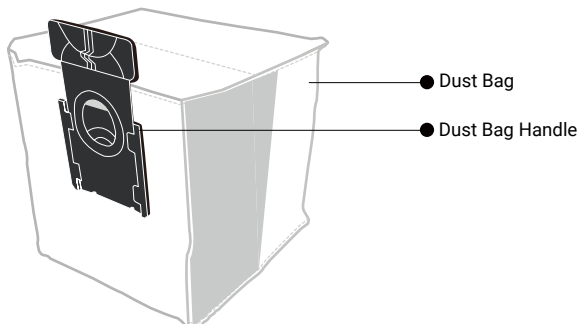





















Name	Description
Auto-empty Base LED Indicator	 Solid White: Robot does not connect to the Auto-empty Base
	 Off: both of Robot and Auto-empty Base are correctly connected/the Auto-empty Base is sleeping
	 Solid Red: the Dust Bag is not in place
	 Fast-flashing Red: abnormal state



## Remote Control



Please ensure that the Robot will response with a beep after you operate the remote control.

Name	Description
Power	Press  once when the Robot is standby, it will sleep. * Under the Sleep Mode, the Robot will enter a low energy-consumption state, you can still use the remote control to operate it.
	Press  once when the Robot is operating, it will become standby. * Under the Standby Mode, the Robot will stop the current task.
Sweep At Fixed Points	Press  to enter Fixed-point Cleaning Mode, it will perform vacuum spirally with a 1.5m in diameter around the current Robot location. * Under this mode, the Robot will vacuum with a increasing radius and then a decreasing radius till back to the original starting point.
Recharge	Press  once, enter Recharge Mode.
Start/Pause	Press  once in Standby Mode, enter the Auto-vacuum Mode. (clean in Zigzagging way first and then along the wall)
	Press  once in any clean mode, enter the Standby Mode.
Suction Regulation	Press *  to adjust the suction regulation. Standard: * Max: 
Time Settings	Press  when the Robot is powered on, the time on the display screen will blink, and then you can select the time you want by pressing  /  .
	Press  or  to switch the time for minute adjustment.
	Press  or  to save your settings.
Sweep Along the Wall	Press  once, enter the Along-wall Clean Mode, the Robot will clean along the wall. * After along-wall cleaning is finished, the Robot will enter the Recharge Mode automatically.
	Press  with the Robot on,  icon and the time on the display screen will blink, and you can press  /  for hour adjustment.
Appointment Settings	Press  or  to switch the time for minute adjustment.
	After settings are completed, press  or  to save it.
	Press and hold  to cancel the appointment settings.

- When controlling the Robot remotely with its Remote Control, stay within the infrared signal range of 7m or the remote control may fail.
- When the Recharge button is pressed, search may fail due to too complicated surrounding obstacles or the exhaustion of the Robot's battery.
- As the infrared ray cannot surpass the wall, please operate the remote control within a visible scope.

# Quick Start Guide

## Preparation

Try to avoid using in the environment with stairs (if must, please set up a guardrail), and try to remove the obstacles on the ground before use.

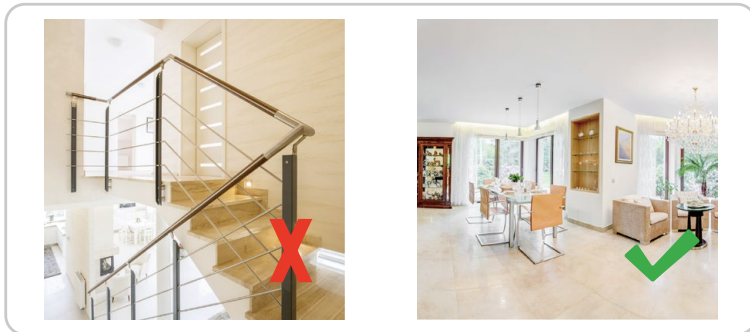

## Connect the Power Supply to the Auto-empty Base

Install the Auto-empty Base in a location that the Robot can easily access. It is recommended to place the Auto-empty Base against a wall, and on a hard-level surface rather than on rugs or carpets.



- In order to avoid external heat damage to the Auto-empty Base, please do not place it next to radiators, heaters, fireplaces, etc.
- For a normal charging process, please do not place the Charging Base in environments subjected to direct sunlight, rain, snow or humidity.

## Remove Shields

Before use, remove the shields on both sides of the Front Bumper and all protective films on both of the Robot and the Auto-empty Base.



## Place the Robot

Place the Robot on the Auto-empty Base and align it with the Charging Electrodes. When the Auto-empty Base Indicator light goes out and the power indicator slow-flashes white, charging will begin.



## Charging

You have two ways to charge the Robot.

Automatic recharging: the Robot will automatically return for recharging after the cleaning task is completed.

Manual recharging:

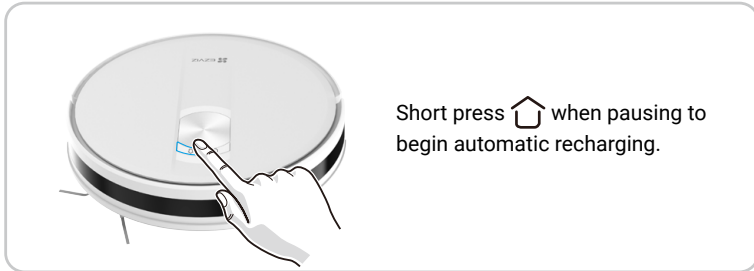

- The Robot needs to be fully charged (approximately 5 hours) to ensure a normal operation.
- After the Robot is docked with the Auto-empty Base, the Auto-empty Base will start to collect dust.
- If the Robot is stucked or cannot find the Auto-empty Base, please manually put the Robot back to the the Auto-empty Base.

## Power On/off

- Power on:
- Press and hold the  button for 4s on the operation panel.
  - After the Robot is docking to the Auto-empty Base, it will be powered on automatically.

Power off: When the Robot is not in the Auto-empty Base, press and hold the  button for 4s on the operation panel.

- After power the Robot off, you cannot use the remote control to operate it.



## Start Cleaning

Short press the  button to start the Full-house Cleaning Mode.

Recommended start the Full-house Cleaning Mode when the Robot is on the Auto-empty Base. The Robot will leave the Auto-empty Base and clean in Zigzagging way, and then clean the area along the wall.

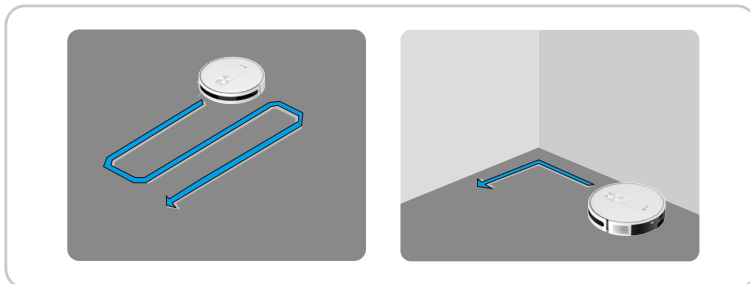

- If the battery level is too low to start cleaning, please charge it first.
- Before cleaning, all wires on the ground should be well organized for fear of power interruption or damage to articles caused by pulling the power cord during cleaning.
- Do not move the Auto-empty Base during cleaning, and make sure that the Auto-empty Base is powered on, otherwise the Robot may not be able to return for charging.

## Pause Cleaning

Pressing  will pause the Robot while cleaning.

Pressing  will stop the Robot while cleaning.

## Sleep



Automatically switch to Sleep Mode:

- The Robot is inactive and the Auto-empty Base is not connected for 10 minutes.
- There is no operation within 10 minutes after the Robot is fully charged.

Manually switch to Sleep Mode:

Press the  button on remote control.

## System Resetting

In Standby Mode, press and hold the  and  button for 15s to reset the system.

After resetting the system, the Robot will lose the original settings and restore to factory settings.



# Routine Maintenance

To maintain the best condition of the device, please maintain the device and replace parts with following frequencies:

Robot Part	Maintenance Frequency	Replacement Frequency
Side Brush	Once every 2 weeks	Every 3-6 months
Main Brush	Once per week	Every 6-12 months
High-performance Filter	Once per week	Every 3-6 months
Edge Sensor Obstacle Sensor Cliff Sensor Infrared Receiving Terminal Bumper Charging Electrode Universal Wheel/Drive Wheel	Once per week	/
Dust Bag	About 90 days	About 90 days

- Before performing cleaning and maintenance tasks on the Robot, turn the Robot OFF and unplug the Auto-empty Base.
- A multi-function Cleaning Tool is provided for easy maintenance. Handle with care, this Cleaning Tool has sharp edges.
- EZVIZ manufactures various replacement parts and fittings. Please visit [www.ezviz.com](http://www.ezviz.com) for more information on replacement parts.

# Dump the Dust Box

Press the Dust Box Taking-out Button to pull out the Dust Box, and then pour the dirt into dust bin.



Remove the Filter out of the Filter Box.



Clean the Filter with Cleaning Tool and flush the Filter and Dust Box thoroughly with water as necessary, and then all cleaned elements shall be thoroughly dried.

- ⓘ Do not clean with hot water or detergent,

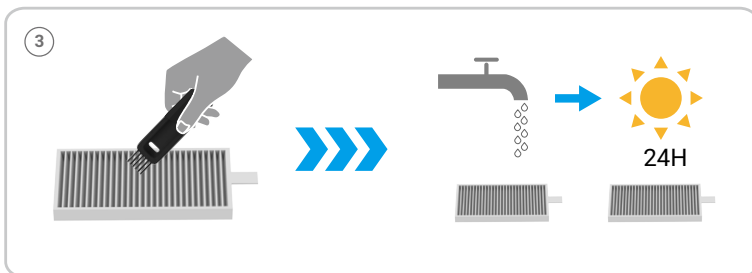

# Clean the Main Brush

Press the buckles to take out the Main Brush Cover and the Main Brush.



Use the blade of the Cleaning Tool to cut off the hair entangled on the Main Brush and remove the roller at one end of the Main Brush to clean it, and then re-install the Main Brush into place.

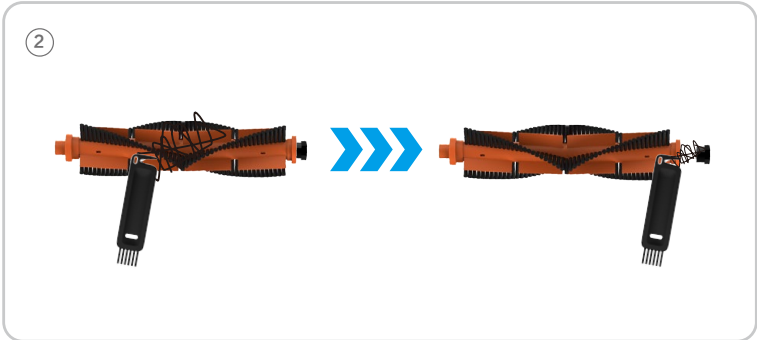

# Clean/Replace the Side Brush

Pull the side brush out and then clean the foreign matters like hairs.

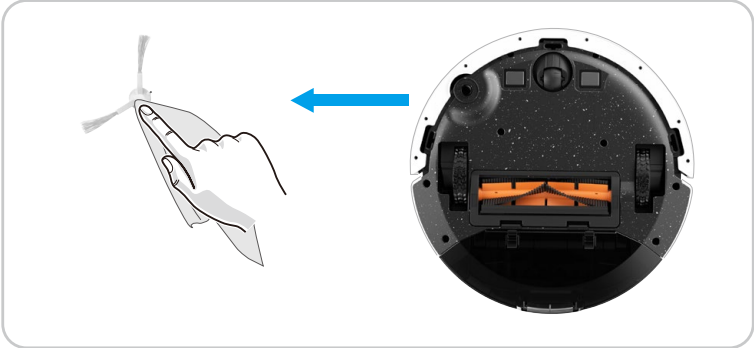

Pull out the old side brush and then press the new one into the position.

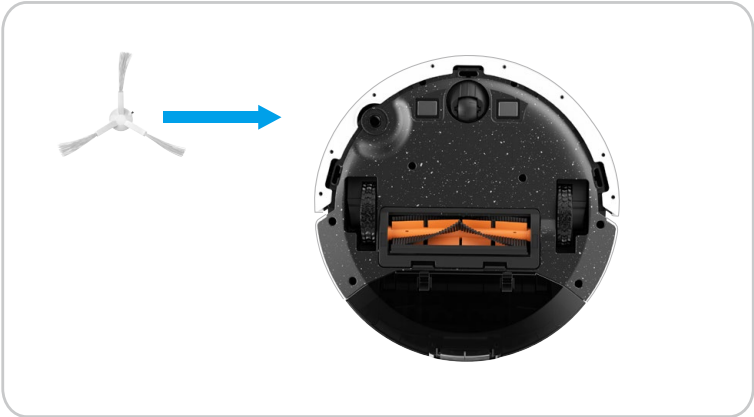

## Clean Universal Wheel

- ① Pull up the Universal Wheel directly by hand then clean it with the hidden Cleaning Tool and then re-install it into place.
- ② Clean the Driven Wheels with the hidden Cleaning Tool.

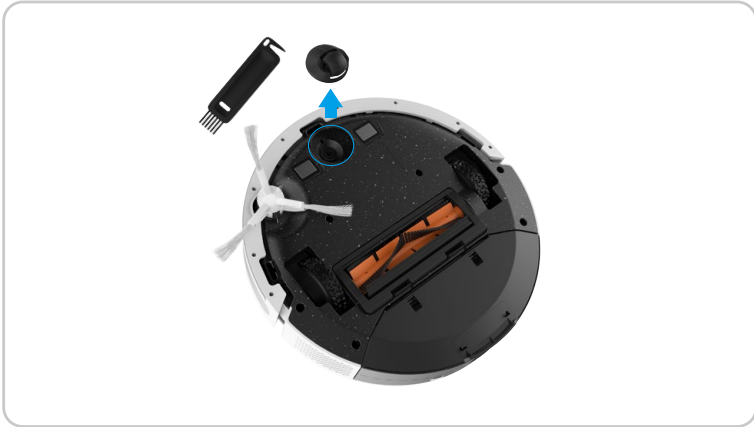

## Clean Sensor

Wipe dust off with a soft dry cloth or cleaning brush.

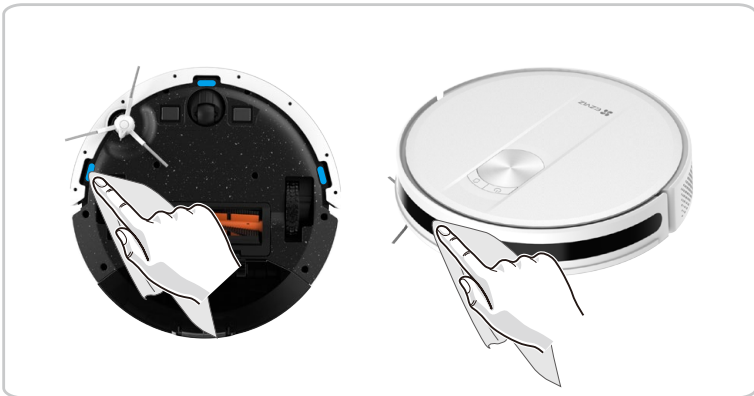

## Clean the Charging Electrode

Wipe off the dust on the Charging Electrodes with a soft dry cloth or cleaning brush.



## Replace the Dust Bag

When the Dust Bag is full, the Auto-empty Base LED Indicator flashes in red.

- ① Open the top cover and pull up the handle of the Dust Bag to take it out;
- ② Discard the old Dust Bag;
- ③ Install a new one and close the top cover.

**i** Violent disassembly is prohibited.

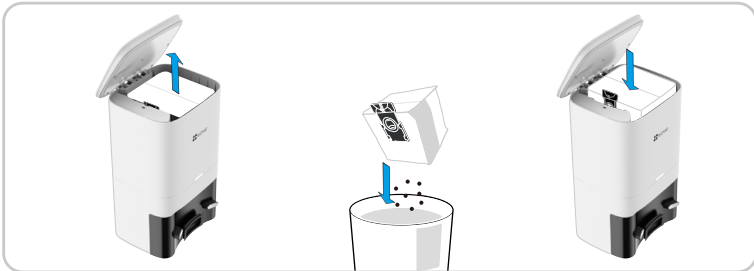

## Clean the Dust Channel

If the Auto-empty Base LED Indicator flashes in red after replacing the Dust Bag, it is recommended to unplug the power plug, reverse the Auto-empty Base to check whether the Dust Channel is blocked by foreign objects.

Use a screwdriver to remove the transparent cover of the Dust Channel, and clean out foreign objects.

- ⓘ Violent disassembly is prohibited.



# Environmental Precautions

The chemical substances contained in the built-in lithium-ion battery of this product may cause environmental pollution. Please remove it before scrapping and send it to a professional battery recycling station for centralized disposal.

Steps for removing the battery (the following information is only applicable when discarding the device, not the daily operation instructions):

1. Let the robot run to a low power state that cannot be cleaned without touching the auto-empty base.
2. Turn off the robot and remove the side brush and dust box.
3. Turn the robot over and remove the screws at the bottom.
4. Remove the battery cover.
5. Take out the battery.

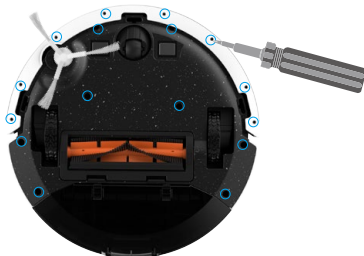

- When disassembling the battery, please ensure that the power is exhausted and operate with the auto-empty base disconnected.
- Please disassemble the whole battery pack together and do not damage the battery pack casing to avoid short circuit or leakage of hazardous substances.
- If the battery has exudate and accidentally touches it, please flush it with plenty of water and seek medical attention promptly.
- This product should not be discarded after the expiration date or after the repair cannot work normally, please hand it over to an enterprise qualified to dispose of WEEE, please refer to the national or local regulations on the disposal of WEEE for the correct method.



Problem	Solution
Startup failure	The battery level is low. Please place the Robot on the Auto-empty Base and align with the Charging Electrodes (When it is completely out of power, it needs to be charged for a while before automatic startup).
	The ambient temperature is too low (below 0°C) or higher than (above 50°C). Please use it within the environmental temperature range of 0-40°C.
Charging failure	Please remove the Robot and check whether the indicator light of the Auto-empty Base is on, and make sure that both ends of the power adapter of the Auto-empty Base are plugged in.
	Poor contact. Please clean up the spring contacts on the Auto-empty Base and the Charging Electrodes on the Robot.
Recharge failure	There are lots of obstacles near the Auto-empty Base. Please place or the Auto-empty Base in an open area.
	The Robot is far from the Auto-empty Base. Please place the Robot near the Auto-empty Base and try again.
Abnormal operation	Shut down and restart.
Abnormal noise during cleaning	There may be foreign matter entangled in the Main Brush, Side Brush or Wheels. Please clean up after shutdown.
Decreased cleaning ability or dirt leakage	The Dust Box is full. Please clean the Dust Box.
	The Filter is clogged. Please clean or replace the Filter.
	The Main Brush is entangled by foreign matter. So please clean the Main Brush.
	The suction port is stucked by foreign matters. Please take out the dust box and clean it.
Scheduled cleaning doesn't work	The battery level is low. Scheduled cleaning will be started when the remaining battery level is $\geq 20\%$ .
	Set the remote control time and scheduled time failed. Please try to adjust the time of the Robot and scheduled time and make sure the settings are effective.
whether the Robot consumes power when it is placed on the auto-empty base all the time	The power consumption is very low when the Robot is placed on the Auto-empty Base all the time, which helps to keep the battery in the best status of performance.

Problem	Solution
Whether the Robot needs to be charged for 16 hours for the first three times	No lithium battery has no memory effect when in use, and there is no need to wait when it is fully charged.
After the Robot returns to the Auto-empty Base, automatic dust collection does not start	<p>Please check whether the Auto-empty Base is normally powered on. When the Robot automatically returns for recharging after more than 5 minutes of cleaning, automatic dust collection will be started.</p> <p>When the Auto-empty Base LED Indicator is flashing red, Please check:</p> <ul style="list-style-type: none"> <li>• whether the top cover of the Auto-empty Base is not closed or improperly closed;</li> <li>• whether a Dust Bag is installed in the Auto-empty Base.</li> </ul> <p>To ensure a smooth dust collection, recommended let the Robot recharge automatically after cleaning (manually moving the Robot back to the Auto-empty Base will cause unstable connection, thus affecting dust collection).</p> <p>Please check the Dust Bag regularly to see if it is full, because overloaded Dust Bag may break, block the dust collection pipe and cause damage to the Auto-empty Base.</p> <p>If the problem persists after the above possible causes have been considered, the components may be abnormal. Please contact the customer service department.</p>
Automatic dust collection is interrupted after startup or garbage collection is not thorough	<p>Check whether the Dust Bag is full. If the Dust Bag is full, replace it.</p> <p>The dust collection outlet of the Dust Box of the Robot is jammed by foreign objects, causing the Dust Box baffle to fail to open.</p> <p>Check whether the air duct of the Auto-empty Base is blocked.</p> <p>During dust collection, the Robot is moved (Please do not move the Robot during dust collection for fear of damage).</p> <p>There may be water in the Dust Box of the Robot, so that dust can not be extracted easily. Please try to prevent the Robot extracting excessive water, which will affect the dust collection performance.</p>
The inner chamber for the Dust Bag of the dust collecting dock is dirty	<p>Fine particles will pass through the Dust Bag and be adsorbed on the inner wall of the dust barrel. Please check and clean up them regularly;</p> <p>The Dust Bag may be damaged. Please check and replace if necessary</p> <p>Severe dirt accumulation in the inner chamber has a certain impact on the fan and air pressure sensor. Recommended to clean up the garbage in the inner chamber regularly.</p>



Problem	Solution
<p>The Robot cannot be controlled accurately by your Remote Control</p>	<p>Check whether the Remote Control has enough power. If the screen can not light up, please replace two new AAA batteries.</p>
	<p>Check whether the Robot has enough power. If the Robot can not be powered on after press and hold the (⏻) Button for 4s, please put the Robot back to Auto-empty Base manually and try again after the Robot is fully charged.</p>
	<p>The Remote Control works with infrared rays and the infrared receiving terminal of the Robot is located on the front of it. Please aimed at the front of the Robot for remote control operations.</p>

 For additional information about the device, please refer to [www.eviz.com/eu](http://www.eviz.com/eu).

# List of Faults

The power indicator will flash in red and the buzzer will give a beep in case that there is an abnormality in the operation of the Robot. Please check the table below to solve your problems.

Voice Prompts	Solutions
“Beeb” “Beeb” “Beeb” (Beeb 3 times continuously, interval 2s, repeat 10 times)	Side Brush module abnormal <ul style="list-style-type: none"> <li>•Please check whether any foreign matter is stuck in a Side Brush and try to restart the Robot.</li> <li>•If the error persists, please contact our Service Department.</li> </ul>
“Beeb” (Interval 2s, repeat 10 times)	Rolling Brush abnormal <ul style="list-style-type: none"> <li>•Please remove and clean it, its connections, its cover and the suction inlet.</li> <li>•Please try to restart the Robot after cleaning.</li> <li>•If the error persists, please contact our Service Department.</li> </ul>
“Beeb” “Beeb” “Beeb” “Beeb” (Beeb 4 times continuously, interval 2s, repeat 10 times)	Abnormal charging Please check the charging area for contamination and try to clean the Charging Electrodes.
	Wheel module abnormal <ul style="list-style-type: none"> <li>•Please check whether any foreign matter is stuck in a wheel and try to restart the Robot.</li> <li>•If the error persists, please contact our Service Department.</li> </ul>
“Beeb” “Beeb” “Beeb” – “Beeb” “Beeb” (Beeb 3 times first and then beeb twice continuously, interval 2s, repeat 10 times):	Fan abnormal <ul style="list-style-type: none"> <li>•Please check whether any foreign matter is stuck in the Fan and try to restart the Robot.</li> <li>•Please clean the Dust Box and filters and try to restart the Robot.</li> <li>•If the error persists, please contact our Service Department.</li> </ul>
“Beeb” “Beeb” “Beeb” “Beeb” – “Beeb” “Beeb” “Beeb” (Beeb 4 times first and then beeb 3 times continuously, interval 2s, repeat 10 times):	Battery abnormal <ul style="list-style-type: none"> <li>•The battery temperature is too high or too low. Please wait for the battery temperature to be normal (0°C~40°C/32°F~104°F) before use.</li> <li>•If the error persists, please contact our Service Department.</li> </ul>

If the corresponding faults cannot be eliminated by referring to the above methods, please press and hold  and  for 15s, and the Robot will restore to factory settings automatically. If still not eliminated, please refer to [www.ezviz.com/eu](http://www.ezviz.com/eu).

## Rechargeable Lithium ion Battery

1. The battery type of the device: Portable battery.
2. The battery of this device is non-removable, which is risky to remove.

Chemical Composition	Chemical Formula	CAS No.	Weight (%)
Lithium transition metal oxide <sup>(2)</sup>	$\text{Li}_x\text{MO}_2$	182442-95-1	37.3%
Carbon(graphite)	C	7782-42-5	21.0%
Aluminum	Al	7429-90-5	3.27%
Copper	Cu	7440-50-8	7.69%
Steel can	Fe	7439-89-6	13.53%
Electrolyte	$\text{C}_3\text{H}_4\text{O}_3$	96-49-1	10.67%
	$\text{C}_4\text{H}_8\text{O}_3$	623-53-0	
	$\text{C}_3\text{H}_6\text{O}_3$	616-38-6	
	$\text{F}_6\text{LiP}$	21324-40-3	
Others		proprietary	6.54%

## INFORMATION FOR PRIVATE HOUSEHOLDS

1. Separate collection of waste equipment: Electrical and electronic equipment that has become waste is referred to as waste equipment. Owners of waste equipment must dispose of it separately from unsorted municipal waste. In particular, waste equipment does not belong in household waste, but in special collection and return systems.

2. Batteries and rechargeable batteries as well as lamps: Owners of waste equipment shall, as a rule, separate waste batteries and rechargeable batteries that are not enclosed in the waste equipment, which can be removed from the waste equipment without being destroyed, from the waste equipment before handing them in at a collection point. This does not apply if waste equipment is prepared for reuse with the participation of a public waste management authority.

3. Options for returning waste equipment: Owners of waste equipment from private households can return it free of charge to the collection points of the public waste management authorities or to the take-back points set up by manufacturers or distributors within the meaning of the Electrical and Electronics Equipment Law. Stores with a sales area of at least 400 m<sup>2</sup> for electrical and electronic equipment and those grocery stores with a total sales area of at least 800 m<sup>2</sup> that offer electrical and electronic equipment several times a year or on a permanent basis and make it available in the market are required to take it back. This also applies in the case of distribution using means of distance communication, if the storage and shipping areas for electrical and electronic equipment are at least 400 m<sup>2</sup> or the total storage and shipping areas are at least 800 m<sup>2</sup>. Distributors shall, in principle, ensure take-back by providing suitable return facilities at a reasonable distance from the respective end user. The possibility of returning waste equipment free of charge exists for distributors who are obliged to take it back, among other things, if a new similar device that essentially fulfills the same functions is delivered to an end user.

4. Privacy Notice: Waste equipment often contains sensitive personal data. This applies in particular to devices of information and telecommunications technology such as computers and smartphones. In your own interest, please note that each end user is responsible for deleting the data on the waste equipment to be disposed of.

5. Meaning of the symbol "crossed-out wheelee bin": The symbol of a crossed-out wheelee bin regularly depicted on electrical and electronic equipment indicates that the respective device is to be collected separately from unsorted municipal waste at the end of its service life.