

Novoferm UK

Price List and Technical Guide

2015



Secured by Design



Official Police Security Initiative

novoferm[®]

a member of the Sanwa Shutter family

www.novoferm.co.uk

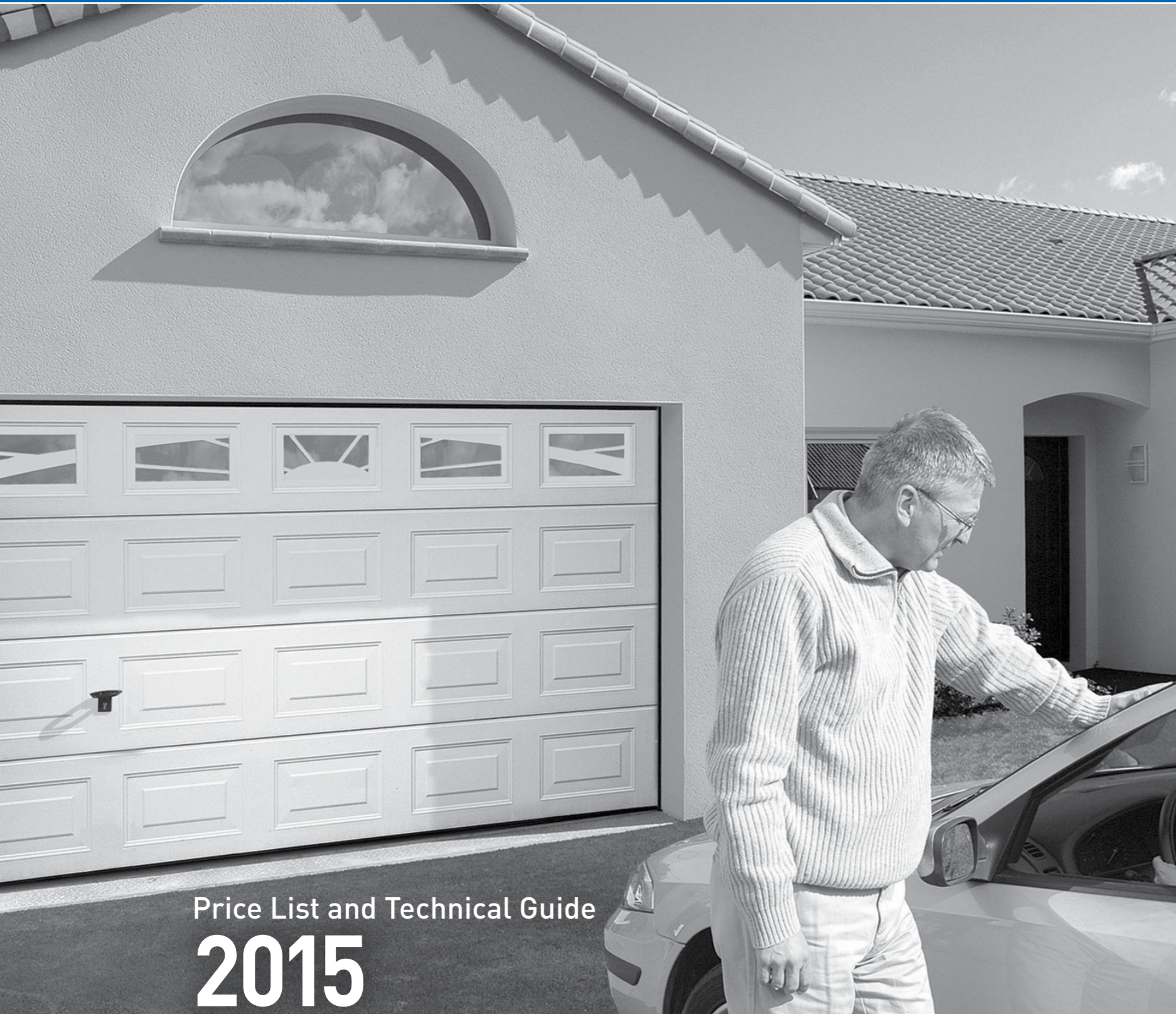

Price List and Technical Guide
2015

The Novoferm product portfolio is available via a national network of Garage Door Specialist Distributors & Installers all of whom are committed to providing you the homeowner with competent advice, service and excellent value.

All Novoferm Garage Doors and Remote Control Systems are manufactured according to the strict Quality Management System ISO 9001 and are independently certified by recognised institutes to the high safety requirements set out by the European Garage Door product standard EN13241-1.



Sectional Garage Doors

steel doors iso20	p4
steel doors iso45	p5
timber doors	p6
matching side doors	p7
specifications & optional extras	p8
side sectional doors NEW prices	p9



Up & Over Garage Doors

steel doors	p10-13
specifications & optional extras	p13
novoguard secured by design doors	p14
steel doors	p16-23
GRP doors	p24-27



Insulated Roller Garage Doors

novoroll insulated roller doors	p28/29
specifications & optional extras	p28/29



Door automation

operators	p30
accessories	p31-33

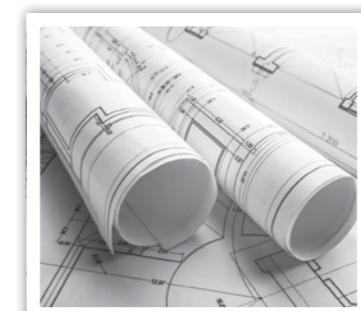

Technical

door technical information	p34/44
tems and conditions	p45
product warranties	p46/47

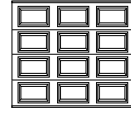

Georgian Panelled

NEW LOWER PRICES

iso20 panelled

standard widths

Intermediate height or width combination Next size +£125

standard heights	Number of windows	2075 6'10"	2134 7'0"	2226 7'4"	2286 7'6"	2438 8'0"	2591 8'6"	2743 9'0"	3000 9'9"
1925 6'4" 2075 6'10"	White Woodgrain	777	777	777	777	805	805	935	980
	Super Colour	1040	1043	1048	1051	1068	1317	1364	1413
2000 6'6" 2125 7'0"	RAL Painted Woodgrain	1155	1161	1171	1177	1203	1460	1515	1582
	White Woodgrain	1350	1350	1372	1372	1405	1497	1687	1876
2250 7'4" 2500 8'2"	Super Colour	1475	1478	1506	1509	1551	1581	1772	1970
2375 7'9"	RAL Painted Woodgrain	1611	1611	1651	1658	1710	1750	1950	2165
	White Woodgrain	1653	1653	1619	1619	1664	-	-	2041
2625 8'9"	Super Colour	1718	1722	1773	1777	1833	1930	2015	2252
	RAL Painted Woodgrain	1874	1881	1941	1948	2015	2124	2220	2480

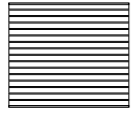

NEW LOWER PRICES

Horizontal Rib

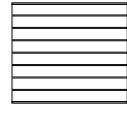

Large Rib

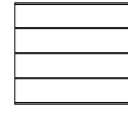

Flush

iso20 ribbed

standard widths

Intermediate height or width combination Next size +£125

standard heights	White Woodgrain	2084 6'10"	2134 7'0"	2235 7'4"	2286 7'6"	2438 8'0"	2591 8'6"	2743 9'0"	3000 9'9"
1925 6'4" 2075 6'10"	Super Colour Woodgrain	905	908	913	916	980	1000	1060	1135
	White Smooth	956	958	964	966	1035	1056	1119	1199
	Super Colour Smooth	1016	1021	1032	1037	1110	1138	1206	1297
2000 6'6" 2125 7'0"	RAL Painted Woodgrain	1020	1026	1036	1042	1115	1143	1211	1304
	RAL Painted Smooth	1131	1139	1155	1163	1245	1281	1357	1466
	White Woodgrain	1153	1153	1173	950	980	1280	1268	1452
2175 7'2" 2375 7'9"	Super Colour Woodgrain	1278	1281	1307	1310	1347	1374	1539	1711
	White Smooth	1393	1393	1426	1098	1148	1577	1680	1859
2200 7'3" 2500 8'2"	Super Colour Smooth	1518	1521	1560	1603	1646	1732	1845	2042
	RAL Painted Woodgrain	1414	1420	1452	1459	1506	1543	1717	1909
2250 7'4"	RAL Painted Smooth	16 54	1660	1705	1752	1805	1901	2023	2240
2625 8'9"	White Woodgrain	1296	1296	1296	1323	1353	1536	1536	1739
	Super Colour Woodgrain	1771	1806	1860	1864	1923	2025	2113	2362
2750 9'0"	White Smooth	1765	1800	1853	1857	1916	2017	2106	2354
	Super Colour Smooth	1915	1953	2014	2022	2091	2204	2303	2573
	RAL Painted Woodgrain	1934	1972	2034	2042	2113	2227	2327	2600
	RAL Painted Smooth	2078	2120	2189	2200	2281	2406	2517	2811

Iso20 Flush only available in smooth finish.

iso 20 sectional doors up to 2125mm 4 panels high, up to 2500mm 5 panels high, up to 3000mm 6 panels high
iso 20 sectional doors have an insulation value of k=1.0 W/mK

Sectional frame heads are colour matched to the door as standard.

Frame leg cover profiles 2.5 m length

White	85mm x 20mm (per pair) 55mm x 20mm (per pair)	Add £42 Add £42
Super Colour	85mm x 20mm (per pair) 55mm x 20mm (per pair)	Add £63 Add £63
RAL colour	85mm x 20mm (per pair) 55mm x 20mm (per pair)	Add £95 Add £95
Golden Oak & Rosewood	85mm x 20mm (per pair) 55mm x 20mm (per pair)	Add £95 Add £95

Super Colour Options

Steel Blue (RAL 5011), Moss Green (RAL 6005)
Fir Green (RAL 6009), Anthracite Grey (RAL 7016)
Ochre Brown (RAL 8001), Nut Brown (RAL 8011)
Sepia Brown (RAL 8014), Light Grey (RAL 7035)
Window Grey (RAL 7040), Black (RAL 9005)

Low Headroom Kit ISO 45mm £105

Glazing Options (for styles see page 8)

Window option clear/crystal, V1, V2, V3 (per window)	White frame add £83 RAL frame add £93
Window option clear/crystal, V4d, V4s (per window)	White frame add £88 RAL frame add £99
Window option V7 aluminium light strip	POA
Window option clear/crystal V8 Portholes - Large rib and flush doors only. (per window)	Each Add £305
NEW Window option R7 Aluminium finish Square (per window)	Add £212
Manual locking with Black D Handle	Add £47
NEW Ventilation grill to suit iso45 (see page 8 for image)	Add £22
Automated Options	
NovoPort (Electric Operator)	Add £399
Additional Micro two channel remote control handsets	Add £60
Additional Mini two channel remote control handsets	Add £60
Additional Mini four channel remote control handsets	Add £63

Sectional doors are bespoke and made to order.

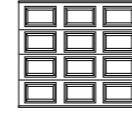

Georgian Panelled

NEW LOWER PRICES

iso45 panelled

standard widths

Intermediate height or width combination Next size +£125

standard heights	Number of windows	2084 6'10"	2134 7'0"	2235 7'4"	2286 7'6"	2388 7'10"	2438 8'0"	2591 8'6"	2743 9'0"	3048 10'0"	3353 11'0"	3658 12'0"	3962 13'0"	4216 13'10"	4267 14'0"	4420 14'6"	4572 15'0"	4877 16'0"	5182 17'0"	5500 18'0"
1875 6'2" 2075 6'10"	White Woodgrain	1049	1087	1086	1086	1145	1145	1149	1248	1264	1670	1751	1872	1680	1680	1838	1890	1950	2587	2824
	Super Colour	1176	1214	1260	1263	1301	1303	1393	1524	1720	1893	1938	2074	1815	1818	1975	2033	2199	2738	3105
1925 6'4" 2125 7'0"	Golden Oak/Rosewood	1235	1275	1323	1326	1366	1436	1393	1524	1651	1893	2035	2178	1906	1909	2074	2135	2386	2522	2763
	RAL Painted Woodgrain	1291	1332	1383	1389	1433	1438	1536	1675	1889	2078	2140	2293	2048	2053	2220	2286	2468	2838	3408
2050 6'9"	White Woodgrain	1502	1502	1609	1155	1609	1215	1767	1770	2108	2280	2450	2512	2574	2636	2697	2767	2855	2882	3026
	Super Colour	1574	1578	1686	1690	1697	1701	1862	2036	2219	2403	2586	2666	2742	2805	2875	2951	3056	3240	3568
2375 7'9"	Golden Oak/Rosewood	1653	1657	1770	1775	1782	1786	1955	2138	2418	2688	2715	2799	2879	2945	3019	3099	3209	3402	3746
	RAL Painted Woodgrain	1730	1737	1854	1861	1876	1883	2056	2241	2447	2654	2860	2963	3058	3124	3205	3293	3421	3628	3980
2500 8'2"	White Woodgrain	2001	2001	2143	2143	2205	2205	2352	2457	2672	2889	3007	3142	3240	3315	3315	3372	-	-	-
	Super Colour	2056	2060	2202	2206	2272	2276	2427	2654	2891	3130	3270	3427	3544	3622	3633	3701	-	-	-
2625 8'9"	Golden Oak/Rosewood	2159	2163	2312	2316	2386	2390	2548	2787	3036	3287	3434	3598	3721	3803	3815	3886	-	-	-
	RAL Painted Woodgrain	2219	2226	2376	2384	2458	2466	2629	2868	3129	3392	3556	3736	3872	3955	3978	4058	-	-	-
2750 9'0"	White Woodgrain	2001	2001	2143	2143	2205	2205	2352	2457	2672	2889	3007	3142	3240	3315	3315	3372	-	-	-
	Super Colour	2056	2060	2202	2206	2272	2276	2427	2654	2891	3130	3270	3427	3544	3622	3633	3701	-	-	-
2875 9'5"	Golden Oak/Rosewood	2159	2163	2312	2316	2386	2390	2548	2787	3036	3287	3434	3598	3721	3803	3815	3886	-	-	-
	RAL Painted Woodgrain	2219	2226	2376	2384	2458	2466	2629	2868	3129	3392	3556	3736	3872	3955	3978	4058	-	-	-
3000 9'9"	White Woodgrain	2001	2001	2143	2143	2205	2205	2352	2457	2672	2889	3007	3142	3240	3315	3315	3372	-	-	-
	Super Colour	2056	2060	2202	2206	2272	2276	2427	2654	2891	3130	3270	3427	3544	3622	3633	3701	-	-	-
2750 9'0"	Golden Oak/Rosewood	2159	2163	2312	2316	2386	2390	2548	2787	3036	3287	3434	3598	3721	3803	3815	3886	-	-	-
	RAL Painted Woodgrain	2219	2226	2376	2384	2458	2466	2629	2868	3129	3392	3556	3736	3872	3955	3978	4058	-	-	-

iso 45 sectional doors up to 2125mm 4 panels high, up to 2500mm 5 panels high, up to 3000mm 6 panels high.

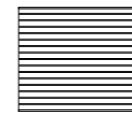

Horizontal Rib



Large Rib



Flush

NEW LOWER PRICES

iso45 ribbed

standard widths

Intermediate height or width combination Next size +£125

standard heights	White-Woodgrain/Smooth	2084 6'10"	2134 7'0"	2235 7'4"	2286 7'6"	2388 7'10"	2438 8'0"	2591 8'6"	2743 9'0"	3048 10'0"	3353 11'0"	3658 12'0"	3962 13'0"	4216 13'10"	4267 14'0"	4420 14'6"	4572 15'0"	4877 16'0"	5182 17'0"	5500 18'0"
1875 6'2" 2075 6'10"	White-Woodgrain/Smooth	850	882	894	894	894	937	929	1013	1051	1197	1402	1453	1509	1515	1515	1587	1655	2229	2434
	Super Colour-Woodgrain/Smooth	1080	1080	1095	1095	1165	1176	1200	1243	1315	1661	1730	1790	1773	1773	1920	2010	2090	2506	2729
2000 6'6" 2125 7'0"	RAL-Woodgrain/Smooth/Satin Grey	1273	1279	1289	1295	1374	1379	1455	1471	1568	1846	2035	2152	1963	1968	1985	2263	2328	2674	2902
	Golden Oak/Rosewood*/Dark Oak*	1158	1161	1166	1169	1242	1244	1225	1320	1399	1661	1833	1933	1817	1817	1827	2010	2059	2506	2729
2050 6'9"	White-Woodgrain/Smooth	1449	1449	1481	1481	1523	1523	1728	1728	2039	2039	2258	2258	2436	2436	2436	2615	2817*	2969*	3206*
	Super Colour-Woodgrain/Smooth	1600	1604	1642	1646	1696	1700	1916	1928	2261	2283	2523	2545	2742	2746	2757	2946	3171*	3345*	3510*
2375 7'9"	RAL-Woodgrain/Smooth/Satin Grey	1680	1687	1732	1739	1794	1801	2019	2041	2381	2425	2677	2721	2927	2934	2956	3148	3385*	3574*	3845*
	Golden Oak/Rosewood*/Dark Oak*	1600	1604																	

Timber Sectional Overhead Garage Doors

Solid wood manufactured from Nordic Pine as standard (or African okoume POA).

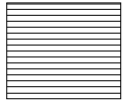
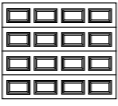
		London (Nordic Pine)				Madrid (Nordic Pine)								
														
Door order heights		No. of windows per panel												
		N/A	N/A	N/A	N/A	N/A	N/A	N/A	N/A	N/A	N/A	N/A	N/A	N/A
Special heights in 25mm increments	3000	5308	5346	5387	5681	5808	6913	6990	-	-	-	-	-	-
	2875	5288	5324	5363	5605	5780	6885	6963	-	-	-	-	-	-
	2750	5262	5298	5340	5630	5746	6847	6922	-	-	-	-	-	-
	2625	4638	4671	4710	4965	5068	6004	6070	6453	-	-	-	-	-
	2500	4614	4586	4683	4933	5041	5969	6036	6432	7219	7303	-	-	-
	2375	4590	4623	4659	4909	4998	5926	5992	6515	7188	7269	7403	-	-
	2250	7636	4513	4551	4794	4896	5829	5888	6274	7057	6084	7243	8063	-
	2125	3868	3899	3929	4137	4232	4990	5041	5367	6003	6072	6169	6836	6896
	2000	3840	3869	3903	4107	4201	4949	5007	5322	5952	6023	6119	6786	6846
	1875	3785	3824	3857	4058	4157	4909	4957	5265	5896	5968	6056	6721	6776
Door widths (intermediate widths available from 2000mm)		2250	2375	2500	2750	3000	3250	3500	3750	4000	4250	4500	4750	5000

For automation of Sectional doors see p30 for prices.

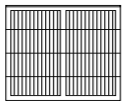
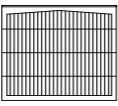





		Thame (Nordic Pine)				Henley (Nordic Pine)								
														
Door order heights		No. of windows per panel												
		N/A	N/A	N/A	N/A	N/A	N/A	N/A	N/A	N/A	N/A	N/A	N/A	N/A
Special heights in 25mm increments	3000	5536	5776	6010	6554	7026	7493	8036	-	-	-	-	-	-
	2875	5397	5627	5857	6385	6847	7300	7826	-	-	-	-	-	-
	2750	5196	5413	5634	6136	6582	7015	7520	-	-	-	-	-	-
	2625	4956	5167	5373	5847	6267	6678	7156	7704	-	-	-	-	-
	2500	4761	4960	5163	5618	6088	6400	6864	7385	7784	8188	-	-	-
	2375	4622	4815	5006	5443	5831	6206	6650	7181	7543	7931	8319	-	-
	2250	4374	4556	4758	5142	5502	5857	6271	6735	7095	7463	7823	8229	-
	2125	4163	4327	4493	4876	5214	5548	5935	6379	6711	7057	7398	7777	8114
	2000	3973	4130	4289	4652	4970	5278	5650	6071	6392	6714	7036	7398	7718
1875	3831	3984	4137	4486	4790	5081	5437	5844	6150	6552	6768	7111	7421	
Door widths (intermediate widths available from 2000mm)		2250	2375	2500	2750	3000	3250	3500	3750	4000	4250	4500	4750	5000

For automation of Sectional doors see p30 for prices.



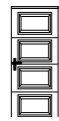

Timber sectional doors are bespoke and made to order.

Sectional iso20/45 Garage Doors - Matching Side Doors



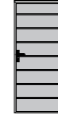

Matching side doors are supplied as standard with matching colour tubular aluminium block frames.

Matching Side Doors - Door order reference (w x h) - to match iso20 and iso45 insulated sectional garage doors								
Imperial	Metric	Overall frame size	Horizontal Rib / Large Rib (woodgrain, white)	Flush (woodgrain, white)	Large Rib (smooth, white)	Flush (smooth, white)	Panelled (woodgrain, white)	Panelled Glazed (woodgrain, white)
			 					
2'10" x 6'6"	875 x 2000	955 x 2040	950	1082	1019	1160	1124	1206
2'10" x 7'0"	875 x 2125	955 x 2165	950	1082	1019	1160	1124	1206
3'3" x 6'6"	1000 x 2000	1080 x 2040	998	1121	1077	1213	1171	1254
3'3" x 7'0"	1000 x 2125	1080 x 2165	998	1121	1077	1213	1171	1254
Special sizes	730 to 1350 x 1815 to 2500	810 to 1430 x 1855 to 2540	1586	1638	1670	1717	1675	1758

Special sizes available on request.

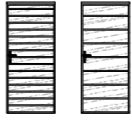
Matching Side Doors - Door order reference (w x h) - to match iso 45 insulated sectional garage doors							
Imperial	Metric	Overall frame size	Large Rib- Satin Grey	Flush - Satin Grey	Horizontal Rib	Large Rib	Flush
							
2'10" x 6'6"	875 x 2000	955 x 2040	1237	1237	1318	1318	1447
2'10" x 7'0"	875 x 2125	955 x 2165	1237	1237	1318	1318	1447
3'3" x 6'6"	1000 x 2000	1080 x 2040	1300	1300	1389	1389	1510
3'3" x 7'0"	1000 x 2125	1080 x 2165	1300	1300	1389	1389	1510
Special sizes	730 to 1350 x 1815 to 2500	810 to 1430 x 1855 to 2540	1775	1827	1811	1843	2000

Special sizes available on request.

Matching Side Doors - Door order reference (w x h) - to match iso 45 insulated sectional garage doors								
Imperial	Metric	Overall frame size	Horizontal Rib / Large Rib Golden Oak Smoothfoil	Flush Golden Oak Smoothfoil	Flush Glazed Golden Oak Smoothfoil	Panelled Golden Oak Smoothfoil	Panelled Glazed Golden Oak Smoothfoil	
								
2'10" x 6'6"	875 x 2000	955 x 2040	1135	1264	1358	1306	1400	
2'10" x 7'0"	875 x 2125	955 x 2165	1135	1264	1358	1306	1400	
3'3" x 6'6"	1000 x 2000	1080 x 2040	1213	1330	1424	1428	1521	
3'3" x 7'0"	1000 x 2125	1080 x 2165	1213	1330	1424	1428	1521	
Special sizes	730 to 1350 x 1815 to 2500	810 to 1430 x 1855 to 2540	1811	1859	1952	1895	1990	

Special sizes available on request.

Matching side doors are bespoke and made to order.

Deluxe, double skin, insulated steel sectional doors - automated or manual operation.

Specification - Sectional iso20/45 Overhead Garage Doors

- All Novoferm iso 20 steel overhead sectional garage doors are supplied 20mm thick double skinned steel sections made of hot galvanised thin sheet, with CFC free PUR rigid foam (insulation value k=1.0 W/m K) giving good heat and sound insulation, anti pinch profile.
- All Novoferm iso 45 steel overhead sectional garage doors are supplied 45mm thick double skinned steel sections made of hot galvanised thin sheet, with CFC free PUR rigid foam (insulation value k=0.5 W/m K) giving excellent heat and sound insulation, anti pinch profile.
- All Novoferm iso 45 timber overhead sectional garage doors are supplied solid wood 20mm thick multi-layered face boards waterproofed glued to a pine sub section overall section thickness 45mm. Doors styles router cut into face boards.
- All Novoferm overhead sectional garage doors are supplied **without locking as standard**.
- All Novoferm iso overhead sectional doors can be supplied with locking if required as an extra, this will be drilled on the right hand side viewed from outside as standard unless otherwise requested.
- Novoferm iso 20 and iso 45 steel overhead sectional door panels are supplied in woodgrain and smooth surface pattern, a pre-finished polyester exterior coating (RAL 9016 as standard).
- All sections are prepared for mounting hardware, floor profile, floor seal and locking (if required).
- All Novoferm timber overhead sectional door panels are supplied in either untreated Nordic pine (softwood) or African Okohume. These doors are supplied untreated and require **immediate** finishing unless fully finished option is specified. See page 46 for more details.
- All Novoferm iso 20 steel overhead sectional garage doors are supplied with triple safety extension spring assemblies.
- All Novoferm iso 45 overhead sectional garage doors are supplied with triple safety extension spring assembly positioned to the rear of the vertical frame legs for doors under 3 metres wide.
- All Novoferm iso 45 overhead sectional doors over 3 metres wide are supplied with front mounted torsion spring shafts and galvanised torsion springs as standard, spring break safety feature tested in accordance with DIN EN 12604 and steel lifting cables. (Optional low head rear mount kit may be added if required).
- All Novoferm iso overhead sectional garage doors are supplied with angle frames and fascia panel made of hot galvanised thin sheet steel with a smooth surface pre-finished polyester coating (white RAL 9016 as standard), frame and fascia seals are black EPDM rubber, **colour matched leg profile covers are available as an optional extra**.

Optional Extras - Sectional iso20/45 Overhead Garage Doors

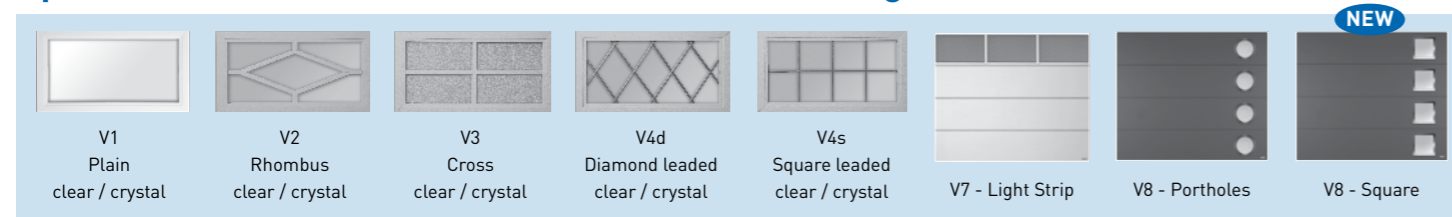

African Okoume option for timber overhead sectional doors. Per m² **Add £84**
 Wicket Doors - iso 45 for horizontal rib, large rib and flush (woodgrain white and smooth finish) size exceptions occur, check when ordering. **Add £1003**

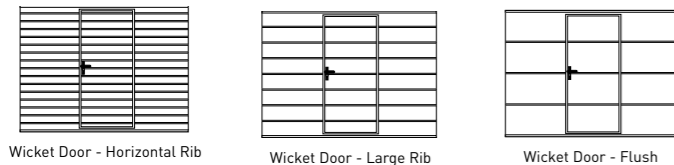

- Manual Locking with Black 'D' handle **Add £45**
- Metallic 'D' handles (White, Brass, Silver and Antique Bronze effect) **Add £99**
- Metallic lever door handles (White, Brass, Silver and Antique bronze effect) **Add £152**
- Low head rear mount kit for iso 45 doors where required. **Add £105**

NEW Aluminium Renovation Profile
 For all types of Novoferm sectional overhead doors. Allows the door to be fitted at the front of the opening and overlapping onto outer brickwork structure (conceals poor brickwork). **Add £402**

NEW Between fix frame brackets (rear mount doors only) Use when fitting between aperture or limited sideroom. Bridges bricks or insulation cavity. **Pack of ten Add £58**

NEW Ventilation grill to suit iso45 **Add £32**

Sunrise Pattern Glazing - iso45 panelled doors, standard sizes Available in white RAL9016 or brown RAL8014

- Co-ord. width 2,000 - 2,600 mm **Add £310**
- Co-ord. width 2,601 - 3,500 mm **Add £412**
- Co-ord. width 3,501 - 4,000 mm* **Add £515**
- Co-ord. width 4,001 - 4,500 mm **Add £617**
- Co-ord. width 4,501 - 5,500 mm* **Add £668**

Delivery for Sunrise glazing 2-3 weeks (items marked * delivery 6 weeks).

3 dimensional fitting brackets
 Perfect fixing brackets for door frames in case of slanted side walls, often used for pre-fabricated concrete garages. Fixing bracket adjustable from 70 - 110°. **NEW Pack of ten Add £58**

		Narrow Rib, Flush & Panelled (woodgrain)			Panelled (golden oak smoothfoil)					
		NEW LOWER PRICES								
Door order heights	No. of windows per panel									
	4	5	6	6	7	7	8	8	8	
Special heights in 25mm increments	3000	3390	3990	4450	4900	5460	5800	6489	6890	7100
	2875	3175	3878	4290	4856	5260	5737	6402	6803	6850
	2750	3001	3768	4168	4736	5196	5645	6390	6615	6780
	2625	2930	3549	4083	4689	5009	5598	5998	6457	6690
	2500	2879	3470	3956	4603	4968	5501	5777	6390	6576
	2375	2718	3404	3890	4528	4906	5478	5789	6170	6378
	2250	2650	3960	3784	4468	4858	5402	5678	6005	6199
	2125	2598	3867	3702	4399	4809	5356	5498	5902	6023
	2000	2509	3801	3658	4367	4768	5269	5456	5789	5878
1875	2480	3768	3604	4288	4666	5207	5314	5505	5999	
Door widths (intermediate widths available from 1600mm)		2500	3000	3500	4000	4250	4500	5000	5500	6000

Above includes: L Rib w/grain- L Rib smooth- Flush smooth-Panelled (All white). Side sectional automation £925.

Side sectional doors are bespoke and made to order.

Optional Extras for Side Sectional Doors

Fully finished colour option, to any RAL colour (excluding metallic or pearlescent finishes), price includes exterior face of door and frame to colour specified. Per m² **Add £53**

- V1 clear/crystal, white. **Add £83 each**
 or choice of RAL colour. **Add £93 each**
 For side curve rebate 150 ← 340 double curve required (must be added for Novoport automation) **Add £263**
 Frame coated in garage door colour **Add £207**
- V2 clear/crystal, white. **Add £83 each**
 or choice of RAL colour. **Add £93 each**
 Header panels iso panel in flush white woodgrain similar to RAL 9016 from 50 to 430mm height. **Add £158 per metre**
 iso panel smoothfoil from 50 to 430mm height. **Add £194 per metre**
- V3 clear/crystal, white. **Add £83 each**
 or choice of RAL colour. **Add £93 each**
 Side panels on the curve side (description as for header panel) side reveal 50 to 430mm width, iso panel, flush white woodgrain **Add £158 per metre**
 side reveal 50 to 430mm width, iso panel, smoothfoil **Add £194 per metre**
- Three point locking for manual doors. **Add £446**

Please Note: Each door is custom designed, number of window panels available on request.

Canopy or Retractable, unframed, with steel infill (white RAL 9016) - manual operation.

G = Available as Glazed door

Single Doors up to 7'3''w x 6'4''h Door Order Ref. (W x H)		Regency ^G		Georgian ^G		Guiltsborough		Minster		Victor		Horsham	
Imperial	Metric	C	R	C	R	C	R	C	R	C	R	C	R
6'6'' x 6'0''	1981 x 1830			736	771					700	735	664	699
6'6'' x 6'2''	1981 x 1880	736	771	736	771			736	771	700	735	664	699
6'6'' x 6'3''	1981 x 1905	736	771	736	771	745	780	736	771	700	735	664	699
6'6'' x 6'4''	1981 x 1930	730	758	730	758	745	780	730	758	700	735	664	699
6'6'' x 6'5''	1981 x 1956	736	771	736	771	745	780	736	771	700	735	664	699
6'6'' x 6'6''	1981 x 1981	685	730	685	730	745	780	685	730	629	664	600	635
6'6'' x 6'9''	1981 x 2056	698	733	698	733	745	780	698	733	629	664	600	635
6'6'' x 6'10''	1981 x 2083	698	733	698	733	745	780	698	733	629	664	600	635
6'6'' x 6'11''	1981 x 2108	698	733	698	733	745	780	698	733	629	664	600	635
6'6'' x 7'0''	1981 x 2134	698	733	698	733	745	780	698	733	629	664	600	635
6'10'' x 6'0''	2083 x 1830	698	733	698	733	745	780	698	733	629	664	600	635
6'10'' x 6'2''	2083 x 1880	698	733	698	733	745	780	698	733	629	664	600	635
6'10'' x 6'3''	2083 x 1905	706	741	706	741	745	780	706	741	645	680	630	665
6'10'' x 6'4''	2083 x 1930	690	739	690	739	745	780	690	739	645	680	630	665
6'10'' x 6'5''	2083 x 1956	707	742	707	742	745	780	707	742	654	689	638	673
6'10'' x 6'6''	2083 x 1981	690	739	690	739	745	780	690	739	654	689	638	673
6'10'' x 6'9''	2083 x 2056	758	793	758	793	745	780	758	793	707	742	690	725
6'10'' x 6'10''	2083 x 2083	758	793	758	793	745	780	758	793	707	742	690	725
6'10'' x 6'11''	2083 x 2108	758	793	758	793	745	780	758	793	707	742	690	725
6'10'' x 7'0''	2083 x 2134	744	779	744	779	745	780	744	779	707	742	690	725
6'11'' x 6'6''	2108 x 1981	758	793	758	793	745	780	758	793	707	742	690	725
6'11'' x 7'0''	2108 x 2134	745	780	745	780	745	780	745	780	707	742	690	725
7'0'' x 6'2''	2134 x 1880	758	793	758	793	745	780	758	793	707	742	690	725
7'0'' x 6'3''	2134 x 1905	758	793	758	793	745	780	758	793	707	742	690	725
7'0'' x 6'4''	2134 x 1930	694	739	694	739	745	780	694	739	641	676	575	610
7'0'' x 6'5''	2134 x 1956	701	736	701	735	745	780	701	735	661	696	575	610
* 7'0'' x 6'6''	2134 x 1981	694	735	694	735	701	736	694	735	575	610	570	605
7'0'' x 6'9''	2134 x 2056	701	736	701	736	701	736	701	736	679	714	615	650
7'0'' x 6'10''	2134 x 2083	701	736	701	736	701	736	701	736	679	714	615	650
7'0'' x 6'11''	2134 x 2108	743	778	743	778	701	736	743	778	679	714	615	650
* 7'0'' x 7'0''	2134 x 2134	735	770	735	770	743	778	735	770	643	628	624	659
7'1'' x 6'4''	2160 x 1930	695	739	695	739	780	815	695	739	679	714	631	666
7'1'' x 6'5''	2160 x 1956	751	786	751	786	780	815	751	786	679	714	631	666
7'1'' x 6'6''	2160 x 1981	695	739	695	739	780	815	695	739	679	714	631	666
7'1'' x 7'0''	2160 x 2134	794	839	794	839	825	860	794	839	643	678	575	610
7'3'' x 6'4''	2210 x 1930	772	807	772	807	825	860	772	807	676	711	631	666

Unframed. Doors and frames come as standard white RAL (9016). C = Canopy Gear, R = Retractable Gear ^G = Available as Glazed door

Rosewood & Golden Oak Laminate

Berwick (Black Glazed)		Berkeley Thornby		Thornby		Naseby		Open for Infil		Thornby Wicket Door	Regency Rosewood & Golden Oak		Single Doors up to 7'3''w x 6'4''h
C	R	C	R	C	R	C	R	C	R	R	C	R	Imperial
		700	735	605	640	531	566	454	489		832	870	6'6'' x 6'0''
		700	735	605	640	531	566	454	489		832	870	6'6'' x 6'2''
		700	735	605	640	531	566	454	489		832	870	6'6'' x 6'3''
		700	735	605	640	531	566	454	489		832	870	6'6'' x 6'4''
		700	735	605	640	531	566	454	489		789	824	6'6'' x 6'5''
		663	698	574	609	502	537	454	489		789	824	6'6'' x 6'6''
		663	698	574	609	534	569	454	489		789	824	6'6'' x 6'9''
		663	698	574	609	534	569	454	489		789	824	6'6'' x 6'10''
		663	698	574	609	534	569	454	489		789	824	6'6'' x 6'11''
		663	698	574	609	534	569	454	489		789	824	6'6'' x 7'0''
927	962	663	698	574	609	534	569	454	489		789	824	6'10'' x 6'0''
927	962	663	698	574	609	534	569	454	489		805	840	6'10'' x 6'2''
961	996	710	745	574	609	534	569	454	489		805	840	6'10'' x 6'3''
961	996	710	745	573	608	504	539	454	489		806	841	6'10'' x 6'4''
961	996	738	773	573	608	524	559	454	489		806	841	6'10'' x 6'5''
1005	1140	738	773	573	608	524	559	454	489		864	899	6'10'' x 6'6''
1043	1078	799	834	585	620	543	578	454	489		864	899	6'10'' x 6'9''
1043	1078	799	834	585	620	543	578	454	489		864	899	6'10'' x 6'10''
1043	1078	799	834	585	620	543	578	454	489		864	899	6'10'' x 6'11''
1043	1078	799	834	585	620	543	578	454	489		864	899	6'10'' x 7'0''
1043	1078	799	834	585	620	543	578	454	489		864	899	6'11'' x 6'6''
1043	1078	799	834	618	653	544	579	454	489		864	899	6'11'' x 7'0''
1043	1078	799	834	618	653	544	579	454	489		864	899	7'0'' x 6'2''
1043	1078	799	834	618	653	544	579	454	489		864	899	7'0'' x 6'3''
923	958	799	645	618	653	512	547	454	489		864	899	7'0'' x 6'4''
952	987	799	645	570	605	512	547	459	489		832	867	7'0'' x 6'5''
923	958	583	618	546	581	473	508	462	497	1953	832	867	7'0'' x 6'6''
961	996	630	665	575	610	520	555	466	501		832	867	7'0'' x 6'9''
961	996	630	665	575	610	520	555	471	506		799	834	7'0'' x 6'10''
961	996	630	665	575	610	520	555	478	513		847	882	7'0'' x 6'11''
961	996	630	665	569	604	520	555	484	519	1953	847	882	7'0'' x 7'0''
974	1009	638	673	565	600	509	544	501	536		850	885	7'1'' x 6'4''
974	1009	638	673	617	652	570	605	517	552		856	891	7'1'' x 6'5''
974	1009	638	673	555	590	509	544	535	570		856	891	7'1'' x 6'6''
974	1009	638	673	630	665	582	617	556	591		921	956	7'1'' x 7'0''
974	1009	638	673	590	625	558	593	563	598		832	867	7'3'' x 6'4''

Unframed. Doors and frames come as standard white RAL (9016). C = Canopy Gear, R = Retractable Gear

* Steel door prices highlighted in bold are standard stock doors on a standard lead time available in white only. All other sizes and prices are non stock doors made to specific requirements.

Steel Up & Over Garage Doors (continued)

Steel Up & Over Garage Doors (continued)

Canopy or Retractable, unframed, with steel infill (white RAL 9016) - manual operation.

G = Available as Glazed door

Single Doors 7'3" w x 6'6" h up to 8'0" w x 7'0" h Door Order Ref. (W x H)		Regency G		Georgian G		Guilborough		Minster		Victor		Horsham	
Imperial	Metric	C	R	C	R	C	R	C	R	C	R	C	R
7'3" x 6'6"	2210 x 1981	736	811	736	811	825	860	736	811	683	718	683	718
7'3" x 7'0"	2210 x 2134	781	816	781	816	825	860	781	816	683	718	683	718
7'5" x 6'4"	2261 x 1930	785	820	785	820	825	860	785	820	683	718	683	718
7'5" x 6'6"	2261 x 1981	730	805	730	805	825	860	730	805	683	718	650	685
7'5" x 7'0"	2261 x 2134	890	925	890	925	825	860	890	925	766	801	730	755
7'6" x 6'4"	2286 x 1930	770	805	770	805	825	860	770	805	700	735	631	666
7'6" x 6'6"	2286 x 1981	770	805	770	805	825	860	770	805	700	735	659	694
7'6" x 7'0"	2286 x 2134	838	865	838	865	951	986	838	865	770	805	730	765
8'0" x 6'2"	2438 x 1880	925	960	925	960	951	986	925	960	828	863	751	786
8'0" x 6'3"	2438 x 1905	925	960	925	960	951	986	925	960	828	863	751	786
8'0" x 6'4"	2438 x 1930	915	940	915	940	951	986	915	940	828	863	728	763
8'0" x 6'5"	2438 x 1956	925	960	925	960	951	986	925	960	865	900	759	794
8'0" x 6'6"	2438 x 1981	915	940	915	940	925	960	915	940	820	855	730	755
8'0" x 6'9"	2438 x 2056	962	997	962	997	962	997	962	997	894	929	775	810
8'0" x 6'10"	2438 x 2083	962	997	962	997	962	997	962	997	894	929	775	810
8'0" x 6'11"	2438 x 2108	962	997	962	997	962	997	962	997	894	929	775	810
8'0" x 7'0"	2438 x 2134	940	975	940	975	962	997	940	975	850	895	750	780

Unframed. Doors and frames come as standard white RAL (9016). C = Canopy Gear, R = Retractable Gear **G** = Available as Glazed door

Rosewood & Golden Oak Laminate

Berwick (Black Glazed)		Berkeley Thornby		Thornby		Naseby		Open for Infill		Thornby Wicket Door	Regency Rosewood & Golden Oak		Single Doors from 7'3" w x 6'6" h
C	R	C	R	C	R	C	R	C	R	R	C	R	Imperial
974	1009	670	705	607	642	566	601	563	598		832	867	7'3" x 6'6"
992	1027	670	705	613	648	574	609	563	598		832	867	7'3" x 7'0"
960	995	670	705	623	658	592	627	565	600		895	930	7'5" x 6'4"
960	995	665	700	595	630	558	593	565	600		889	924	7'5" x 6'6"
975	1010	732	767	679	714	635	670	565	600		889	924	7'5" x 7'0"
975	1010	672	707	613	648	558	593	554	589		889	924	7'6" x 6'4"
975	1010	638	673	613	648	558	593	554	589	1953	889	924	7'6" x 6'6"
975	1010	703	738	672	707	636	671	554	589	1953	1025	1060	7'6" x 7'0"
1047	1082	741	776	734	769	645	680	554	589		1055	1090	8'0" x 6'2"
1047	1082	741	776	734	769	645	680	554	589		1055	1090	8'0" x 6'3"
1027	1062	741	776	737	762	645	680	554	589		1055	1090	8'0" x 6'4"
1047	1082	741	776	734	769	645	680	554	589		1055	1090	8'0" x 6'5"
1027	1062	741	776	737	762	644	679	530	565	1953	1055	1090	8'0" x 6'6"
1059	1094	753	788	759	794	657	692	556	591		1097	1132	8'0" x 6'9"
1059	1094	753	788	759	794	657	692	556	591		1097	1132	8'0" x 6'10"
1059	1094	753	788	759	794	657	692	556	591		1097	1132	8'0" x 6'11"
1027	1062	753	788	750	785	657	692	530	563	1953	1097	1132	8'0" x 7'0"

Unframed. Doors and frames come as standard white RAL (9016). C = Canopy Gear, R = Retractable Gear

Matching Side Doors Door Order Ref. (W x H)		Regency	Georgian	Victor	Horsham
Imperial	Metric				
2'10" x 6'2"	875 x 1875	764	764	647	647
2'10" x 6'6"	875 x 2000	764	764	657	657
2'10" x 7'0"	875 x 2125	771	771	666	666
3'3" x 6'6"	1000 x 2000	785	785	681	681
3'3" x 7'0"	1000 x 2125	791	791	578	578

Matching side doors are supplied as standard with colour matching, tubular steel block.

Matching Side Doors Door Order Ref. (W x H)		Berkeley Thornby	Thornby	Naseby	Open for infill	Regency Rosewood & Golden Oak
Imperial	Metric					
2'10" x 6'2"	875 x 1875	572	545	545	545	914
2'10" x 6'6"	875 x 2000	580	552	552	552	914
2'10" x 7'0"	875 x 2125	587	559	559	559	921
3'3" x 6'6"	1000 x 2000	601	572	572	572	935
3'3" x 7'0"	1000 x 2125	607	578	578	578	941

Matching side doors are supplied as standard with colour matching, tubular steel block.

Specification

- Novoferm Up and Over garage doors are spring assisted canopy or retractable action for smooth running. The door slides up and over into the garage, providing safe and very reliable operation.
- Factory fitted canopy frames are 54mm wide as standard. Retractable frames are 70mm.
- Novoferm Up & Over garage doors can be supplied in a pre-hung factory finished steel fixing frame, which makes installation simple and eliminates the need for a timber frame.
- Frames are supplied as standard in white, colour matched frames are also available (please see the Optional Extras section).
- All Up & Over garage doors are supplied with our black "D" handle (see page 22 in the Novoferm brochure).
- Open for Infill have a maximum infill weight of 7kg/m²
- Berwick is supplied with black windows as standard. Translucent are also available as an option.
- Regency Golden Oak chassis frame is supplied in RAL8011. Rosewood in RAL8015.
- Steel doors including windows. The standard colour window frame for white coloured doors is white. For non-white coloured doors and for Rosewood and Golden Oak laminated doors the window frame colour will be Black. Colour matched window frames are available but must be specified at time of order.

Optional Extras

Super colours are available for all Steel Up & Over garage doors
 Door panel Add £98
 Matching steel frame Add £28
Colours available:
 RAL7016 Anthracite Grey, Special Metallic Grey, RAL6005 Balmoral Green, RAL5013 Oxford Blue, RAL5001 Midnight Blue, RAL3003 Monarch Red, RAL3004 Burgundy, RAL8017 Conker Brown, RAL9001 Cream, RAL9005 Ebony Black, Cherry
New Colour Range:
 RAL7004 Signal Grey, RAL7035 Light Grey, RAL7038 Ageta Grey, RAL9007 Aluminium Grey, BS4800-14C35 Chartwell Green, BS4800-12B17 Willow Green, BS381-420 Dark Camouflage Desert Sand, BS381-389 Camouflage Beige, RAL5024 Pastel Blue, RAL3020 Traffic Red, RAL8001 Ochre Brown, RAL8002 Signal Brown, RAL1015 Light Ivory

Factory fitted steel fixing frames
 Standard frame width 70mm. A 54mm wide frame is also available. Please specify at time of order. Add £105
Coloured window frames to match door colour:
 Regency and Georgian (per window) Add £28
 Berwick (per door) Add £115
Glazing options are available as follows:
 Regency, Georgian, in Plain, Stippled, Transparent, Diamond Lattice, Queen Anne Lattice or Square Lattice Add £268
 Berwick has the option of translucent windows (please specify at time of order)

Retractable, pre-framed, with steel infill (white RAL 9016) - manual operation.

Novoguard Secured by Design Single Doors Door Order Ref. (W x H)		Naseby	Thornby
Imperial	Metric	R	R
6'6" x 6'0"	1984 x 1830	924	975
6'6" x 6'3"	1984 x 1905	924	975
6'6" x 6'4"	1984 x 1930	924	975
6'6" x 6'6"	1981 x 1981	897	946
6'10" x 6'4"	2085 x 1930	907	946
6'10" x 6'6"	2085 x 1981	920	946
6'10" x 7'0"	2085 x 2134	938	957
7'0" x 6'0"	2134 x 1830	939	989
7'0" x 6'3"	2134 x 1905	939	989
7'0" x 6'4"	2134 x 1930	912	948
7'0" x 6'6"	2134 x 1981	854	920
7'0" x 7'0"	2134 x 2134	921	944
7'3" x 6'4"	2225 x 1930	958	974
7'3" x 6'6"	2225 x 1981	961	974
7'3" x 7'0"	2225 x 2134	969	974
7'5" x 6'4"	2260 x 1930	987	1006
7'5" x 6'6"	2260 x 1981	958	981
7'5" x 7'0"	2260 x 2134	1017	1037
7'6" x 6'4"	2285 x 1930	957	995
7'6" x 6'6"	2285 x 1981	957	995
7'6" x 7'0"	2285 x 2134	1036	1053
8'0" x 6'4"	2438 x 1930	1111	1107
8'0" x 6'6"	2438 x 1981	1189	1107
8'0" x 7'0"	2438 x 2134	1217	1107

Specification

- NovoGuard garage doors are spring assisted retractable action for smooth running. The door slides up and over into the garage, providing safe and very reliable operation.
- Factory fitted steel frames as standard 70mm wide.
- Novoguard Up & Over garage doors can only be supplied in a pre-hung factory finished steel fixing frame, which makes installation simple and eliminates the need for a timber frame which can warp or rot over time. These frames are supplied as standard in white, however colour matched frames are also available (please see the Optional Extras section).
- All Up & Over garage doors are supplied with our black "D" handle (see page 22 in the Novoferm brochure).
- Novoguard doors are bespoke and made to order.

Secured by Design



Official Police Security Initiative

Novoguard Thornby and Naseby Secured by Design doors are certificated to CS 5051 STS202 which is approved by ACPO Association Of Chief Police Officers

Optional Extras

Super colours are available for all Steel Up & Over garage doors as follows:

Door panel

Add £98

Matching steel frame

Add £28

Colours available:

RAL7016 Anthracite Grey, Special Metallic Grey, RAL6005 Balmoral Green, RAL5013 Oxford Blue, RAL5001 Midnight Blue, RAL3003 Monarch Red, RAL3004 Burgundy, RAL8017 Conker Brown, RAL9001 Cream, RAL9005 Ebony Black, Cherry

New Colour Range:

RAL7004 Signal Grey, RAL7035 Light Grey, RAL7038 Ageta Grey, RAL9007 Aluminium Grey, BS4800-14C35 Chartwell Green, BS4800-12B17 Willow Green, BS381-420 Dark Camouflage Desert Sand, BS381-389 Camouflage Beige, RAL5024 Pastel Blue, RAL3020 Traffic Red, RAL8001 Ochre Brown, RAL8002 Signal Brown, RAL1015 Light Ivory

Reverse of door showing strengthening ribs, 3 point locking and heavy duty springs

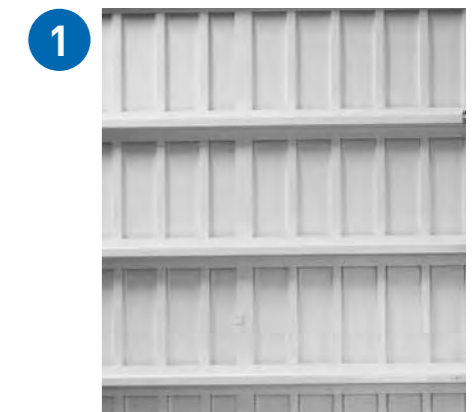

To meet the exacting standards we have increased the number of door braces at the rear of the door

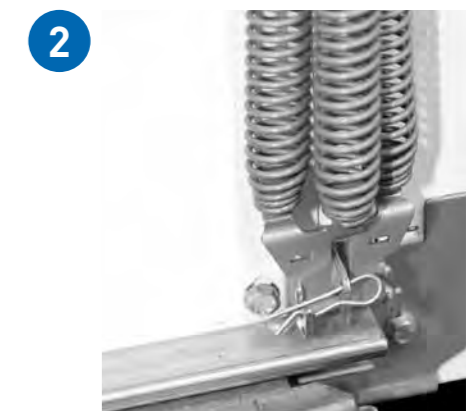

Multi springing ensures smooth operation of the reinforced door



3-point solid bar locking fully supported across the width of the door



The reinforced locking barrel includes a key for locking and unlocking from the inside of your garage. The door is fully operational from both inside and outside of your garage

Timber Up & Over Garage Doors (Futura range)

Canopy or Retractable, unframed, with timber infill (Brown RAL8014 chassis) - manual operation.

G = Available as Glazed door

Single Doors up to 7'3" w x 6'4" h Door Order Ref. (W x H)		Caithness		Cleveland		Dorset ^G		Gatley ^G		Henley		Hertford	
Imperial	Metric	C	R	C	R	C	R	C	R	C	R	C	R
6'6" x 6'0"	1981 x 1830	1513	1548	1596	1631	1649	1684	1745	1780	1537	1572	1834	1869
6'6" x 6'2"	1981 x 1880	1513	1548	1596	1631	1649	1684	1745	1780	1537	1572	1834	1869
6'6" x 6'3"	1981 x 1905	1513	1548	1596	1631	1649	1684	1745	1780	1537	1572	1834	1869
6'6" x 6'4"	1981 x 1930	1513	1548	1596	1631	1649	1684	1745	1780	1537	1572	1834	1869
6'6" x 6'5"	1981 x 1956	1513	1548	1596	1631	1649	1684	1745	1780	1537	1572	1834	1869
6'6" x 6'6"	1981 x 1981	1513	1548	1596	1631	1649	1684	1745	1780	1537	1572	1834	1869
6'6" x 6'9"	1981 x 2056	1513	1548	1596	1631	1649	1684	1745	1780	1537	1572	1834	1869
6'6" x 6'10"	1981 x 2083	1513	1548	1596	1631	1649	1684	1745	1780	1537	1572	1834	1869
6'6" x 6'11"	1981 x 2108	1513	1548	1596	1631	1649	1684	1745	1780	1537	1572	1834	1869
6'6" x 7'0"	1981 x 2134	1513	1548	1596	1631	1649	1684	1745	1780	1537	1572	1834	1869
6'10" x 6'0"	2083 x 1830	1547	1582	1617	1652	1683	1718	1760	1795	1586	1621	1849	1884
6'10" x 6'2"	2083 x 1880	1547	1582	1617	1652	1683	1718	1760	1795	1586	1621	1849	1884
6'10" x 6'3"	2083 x 1905	1547	1582	1617	1652	1683	1718	1760	1795	1586	1621	1849	1884
6'10" x 6'4"	2083 x 1930	1547	1582	1617	1652	1683	1718	1760	1795	1586	1621	1849	1884
6'10" x 6'5"	2083 x 1956	1547	1582	1617	1652	1683	1718	1760	1795	1586	1621	1849	1884
6'10" x 6'6"	2083 x 1981	1547	1582	1617	1652	1683	1718	1760	1795	1586	1621	1849	1884
6'10" x 6'9"	2083 x 2056	1547	1582	1617	1652	1683	1718	1760	1795	1586	1621	1849	1884
6'10" x 6'10"	2083 x 2083	1547	1582	1617	1652	1683	1718	1760	1795	1586	1621	1849	1884
6'10" x 6'11"	2083 x 2108	1547	1582	1617	1652	1683	1718	1760	1795	1586	1621	1849	1884
6'10" x 7'0"	2083 x 2134	1547	1582	1617	1652	1683	1718	1760	1795	1586	1621	1849	1884
6'11" x 6'6"	2108 x 1981	1588	1623	1649	1684	1699	1734	1792	1827	1605	1640	1849	1884
6'11" x 7'0"	2108 x 2134	1588	1623	1649	1684	1699	1734	1792	1827	1605	1640	1849	1884
7'0" x 6'2"	2134 x 1880	1588	1623	1649	1684	1699	1734	1792	1827	1605	1640	1849	1884
7'0" x 6'3"	2134 x 1905	1588	1623	1649	1684	1699	1734	1792	1827	1605	1640	1849	1884
7'0" x 6'4"	2134 x 1930	1467	1502	1561	1596	1605	1640	1709	1744	1605	1640	1849	1884
7'0" x 6'5"	2134 x 1956	1467	1502	1561	1596	1605	1640	1709	1744	1605	1640	1849	1884
7'0" x 6'6"	2134 x 1981	1441	1476	1520	1555	1541	1576	1659	1694	1410	1445	1747	1782
7'0" x 6'9"	2134 x 2056	1441	1476	1520	1555	1567	1602	1659	1694	1463	1498	1760	1795
7'0" x 6'10"	2134 x 2083	1441	1476	1520	1555	1567	1602	1659	1694	1463	1498	1760	1795
7'0" x 6'11"	2134 x 2108	1441	1476	1520	1555	1567	1602	1659	1694	1463	1498	1760	1795
7'0" x 7'0"	2134 x 2134	1444	1479	1579	1614	1549	1584	1687	1722	1417	1452	1827	1862
7'1" x 6'4"	2160 x 1930	1459	1494	1570	1605	1594	1629	1720	1755	1497	1532	1839	1874
7'1" x 6'5"	2160 x 1956	1459	1494	1570	1605	1594	1629	1720	1755	1497	1532	1839	1874
7'1" x 6'6"	2160 x 1981	1459	1494	1570	1605	1594	1629	1720	1755	1497	1532	1839	1874
7'1" x 7'0"	2160 x 2134	1459	1494	1570	1605	1594	1629	1720	1755	1497	1532	1839	1874
7'3" x 6'4"	2210 x 1930	1459	1494	1570	1605	1594	1629	1720	1755	1497	1532	1839	1874

Unframed. C = Canopy Gear, R = Retractable Gear ^G = Available as Glazed door

Timber Up & Over Garage Doors (Futura range)

G = Available as Glazed door

Single Doors up to 7'3" w x 6'4" h Door Order Ref. (W x H)		Horizontal		Kimberley ^G		Madeley		Thame		Vertical	
Imperial	Metric	C	R	C	R	C	R	C	R	C	R
6'6" x 6'0"	1981 x 1830	1376	1411	1882	1917	1834	1869	1569	1604	1299	1334
6'6" x 6'2"	1981 x 1880	1376	1411	1882	1917	1834	1869	1569	1604	1299	1334
6'6" x 6'3"	1981 x 1905	1376	1411	1882	1917	1834	1869	1569	1604	1299	1334
6'6" x 6'4"	1981 x 1930	1376	1411	1882	1917	1834	1869	1569	1604	1299	1334
6'6" x 6'5"	1981 x 1956	1376	1411	1882	1917	1834	1869	1569	1604	1299	1334
6'6" x 6'6"	1981 x 1981	1376	1411	1882	1917	1834	1869	1569	1604	1299	1334
6'6" x 6'9"	1981 x 2056	1376	1411	1882	1917	1834	1869	1569	1604	1299	1334
6'6" x 6'10"	1981 x 2083	1376	1411	1882	1917	1834	1869	1569	1604	1299	1334
6'6" x 6'11"	1981 x 2108	1376	1411	1882	1917	1834	1869	1569	1604	1299	1334
6'6" x 7'0"	1981 x 2134	1376	1411	1882	1917	1834	1869	1569	1604	1299	1334
6'10" x 6'0"	2083 x 1830	1397	1432	1917	1952	1849	1884	1617	1652	1313	1348
6'10" x 6'2"	2083 x 1880	1397	1432	1917	1952	1849	1884	1617	1652	1313	1348
6'10" x 6'3"	2083 x 1905	1397	1432	1917	1952	1849	1884	1617	1652	1313	1348
6'10" x 6'4"	2083 x 1930	1397	1432	1917	1952	1849	1884	1617	1652	1313	1348
6'10" x 6'5"	2083 x 1956	1397	1432	1917	1952	1849	1884	1617	1652	1313	1348
6'10" x 6'6"	2083 x 1981	1397	1432	1917	1952	1849	1884	1617	1652	1313	1348
6'10" x 6'9"	2083 x 2056	1397	1432	1917	1952	1849	1884	1617	1652	1313	1348
6'10" x 6'10"	2083 x 2083	1397	1432	1917	1952	1849	1884	1617	1652	1313	1348
6'10" x 6'11"	2083 x 2108	1397	1432	1917	1952	1849	1884	1617	1652	1313	1348
6'10" x 7'0"	2083 x 2134	1397	1432	1917	1952	1849	1884	1617	1652	1313	1348
6'11" x 6'6"	2108 x 1981	1397	1432	1917	1952	1849	1884	1666	1701	1313	1348
6'11" x 7'0"	2108 x 2134	1397	1432	1917	1952	1849	1884	1666	1701	1313	1348
7'0" x 6'2"	2134 x 1880	1386	1421	1943	1978	1849	1884	1666	1701	1348	1383
7'0" x 6'3"	2134 x 1905	1386	1421	1943	1978	1849	1884	1666	1701	1348	1383
7'0" x 6'4"	2134 x 1930	1386	1421	1943	1978	1849	1884	1507	1542	1348	1383
7'0" x 6'5"	2134 x 1956	1386	1421	1943	1978	1849	1884	1507	1542	1348	1383
7'0" x 6'6"	2134 x 1981	1310	1345	1797	1832	1747	1782	1475	1510	1248	1283
7'0" x 6'9"	2134 x 2056	1365	1400	1827	1862	1760	1795	1475	1510	1303	1338
7'0" x 6'10"	2134 x 2083	1365	1400	1827	1862	1760	1795	1475	1510	1303	1338
7'0" x 6'11"	2134 x 2108	1365	1400	1827	1862	1760	1795	1475	1510	1303	1338
7'0" x 7'0"	2134 x 2134	1310	1345	1825	1875	1827	1862	1483	1518	1258	1293
7'1" x 6'4"	2160 x 1930	1359	1394	1841	1876	1839	1874	1541	1576	1314	1349
7'1" x 6'5"	2160 x 1956	1359	1394	1841	1876	1839	1874	1541	1576	1314	1349
7'1" x 6'6"	2160 x 1981	1359	1394	1841	1876	1839	1874	1541	1576	1314	1349
7'1" x 7'0"	2160 x 2134	1359	1394	1841	1876	1839	1874	1541	1576	1314	1349
7'3" x 6'4"	2210 x 1930	1359	1394	1841	1876	1839	1874	1541	1576	1314	1349

Unframed. C = Canopy Gear, R = Retractable Gear ^G = Available as Glazed door

Timber Up & Over Garage Doors (Futura range continued)

Timber Up & Over Garage Doors (Futura range continued)

Canopy or Retractable, unframed, with timber infill (Brown RAL8014 chassis) - manual operation.

G = Available as Glazed door

Single Doors 7'3" w x 6'6" h up to 8'0" w x 7'0" h Door Order Ref. (W x H)		Caithness		Cleveland		Dorset G		Gatley G		Henley		Hertford	
Imperial	Metric	C	R	C	R	C	R	C	R	C	R	C	R
7'3" x 6'6"	2210 x 1981	1459	1494	1570	1605	1594	1629	1720	1755	1497	1532	1839	1874
7'3" x 7'0"	2210 x 2134	1459	1494	1570	1605	1594	1629	1720	1755	1497	1532	1839	1874
7'5" x 6'4"	2261 x 1930	1459	1494	1570	1605	1594	1629	1782	1882	1497	1532	1839	1874
7'5" x 6'6"	2261 x 1981	1459	1494	1570	1605	1594	1629	1782	1882	1497	1532	1839	1874
7'5" x 7'0"	2261 x 2134	1459	1494	1570	1605	1594	1629	1782	1882	1497	1532	1839	1874
7'6" x 6'4"	2286 x 1930	1459	1494	1570	1605	1594	1629	1764	1799	1497	1532	1839	1874
7'6" x 6'6"	2286 x 1981	1478	1513	1599	1646	1586	1671	1764	1799	1520	1555	1957	2007
7'6" x 7'0"	2286 x 2134	1509	1544	1667	1717	1632	1667	1777	1812	1563	1548	1957	1992
8'0" x 6'2"	2438 x 1880	1583	1618	1717	1752	1691	1726	1798	1833	1563	1548	1957	1992
8'0" x 6'3"	2438 x 1905	1583	1618	1717	1752	1691	1726	1798	1833	1563	1548	1957	1992
8'0" x 6'4"	2438 x 1930	1583	1618	1717	1752	1691	1726	1798	1833	1563	1548	1957	1992
8'0" x 6'5"	2438 x 1956	1583	1618	1717	1752	1691	1726	1798	1833	1563	1548	1957	1992
8'0" x 6'6"	2438 x 1981	1519	1554	1789	1839	1671	1706	1808	1843	1585	1635	2031	2081
8'0" x 6'9"	2438 x 2056	1597	1632	1833	1868	1717	1752	1848	1883	1615	1650	2031	2066
8'0" x 6'10"	2438 x 2083	1597	1632	1833	1868	1717	1752	1848	1883	1615	1650	2031	2066
8'0" x 6'11"	2438 x 2108	1597	1632	1833	1868	1717	1752	1848	1883	1615	1650	2031	2066
8'0" x 7'0"	2438 x 2134	1553	1588	1846	1881	1698	1733	1808	1843	1588	1638	2085	2135

Unframed. C = Canopy Gear, R = Retractable Gear G = Available as Glazed door

Matching Side Doors Door Order Ref. (W x H)		Caithness	Dorset	Gatley	Henley	Hertford
Imperial	Metric					
2'10" x 6'2"	875 x 1875	1054	1106 G	1106 G	1054	1054
2'10" x 6'6"	875 x 2000	1061	1109	1109	1061	1061
2'10" x 7'0"	875 x 2125	1064	1117	1117	1064	1064
3'3" x 6'6"	1000 x 2000	1075	1128	1128	1075	1075
3'3" x 7'0"	1000 x 2125	1084	1134	1134	1084	1084

Matching side doors are supplied as standard with brown RAL 8014, tubular steel block frames. G = Available as Glazed door

Specification

- Novoferm Up and Over garage doors are spring assisted canopy or retractable action for smooth running. The door slides up and over into the garage, providing safe and very reliable operation.
- Novoferm Up & Over garage doors can be supplied in a pre-hung factory finished steel frame, which makes installation simple and eliminates the need for a timber frame.
- Timber doors are supplied with a basecoat stain as standard. They must be finished **immediately** after installation.
- Frames are supplied as standard in brown.
- Novoferm Timber garage doors are supplied as standard with brown coloured chassis surrounding the timber panel.
- Timber doors are supplied with a door handle. If you prefer a door without a handle, you must specify when you order.
- Timber doors are bespoke and made to order.
- Please see page 46 for more details.

G = Available as Glazed door

Single Doors 7'3" w x 6'6" h up to 8'0" w x 7'0" h Door Order Ref. (W x H)		Horizontal		Kimberley G		Madeley		Thame		Vertical	
Imperial	Metric	C	R	C	R	C	R	C	R	C	R
7'3" x 6'6"	2210 x 1981	1359	1394	1841	1876	1839	1874	1541	1576	1314	1349
7'3" x 7'0"	2210 x 2134	1359	1394	1841	1876	1839	1874	1541	1576	1314	1349
7'5" x 6'4"	2261 x 1930	1359	1394	1841	1876	1839	1874	1564	1599	1314	1349
7'5" x 6'6"	2261 x 1981	1359	1394	1841	1876	1839	1874	1564	1599	1314	1349
7'5" x 7'0"	2261 x 2134	1359	1394	1841	1876	1839	1874	1564	1599	1314	1349
7'6" x 6'4"	2286 x 1930	1359	1394	1841	1876	1839	1874	1580	1615	1314	1349
7'6" x 6'6"	2286 x 1981	1351	1401	1841	1876	1957	2007	1520	1555	1340	1390
7'6" x 7'0"	2286 x 2134	1351	1386	1902	1937	1957	1992	1532	1567	1340	1375
8'0" x 6'2"	2438 x 1880	1351	1386	1902	1937	1957	1992	1597	1630	1340	1375
8'0" x 6'3"	2438 x 1905	1351	1386	1902	1937	1957	1992	1597	1630	1340	1375
8'0" x 6'4"	2438 x 1930	1351	1386	1902	1937	1957	1992	1597	1630	1340	1375
8'0" x 6'5"	2438 x 1956	1351	1386	1902	1937	1957	1992	1597	1630	1340	1375
8'0" x 6'6"	2438 x 1981	1441	1491	1910	1945	2031	2081	1585	1620	1430	1480
8'0" x 6'9"	2438 x 2056	1441	1476	1910	1945	2031	2066	1604	1639	1430	1475
8'0" x 6'10"	2438 x 2083	1441	1476	1910	1945	2031	2066	1604	1639	1430	1475
8'0" x 6'11"	2438 x 2108	1441	1476	1910	1945	2031	2066	1604	1639	1430	1475
8'0" x 7'0"	2438 x 2134	1469	1519	1946	1996	2085	2135	1588	1673	1458	1508

Unframed. C = Canopy Gear, R = Retractable Gear G = Available as Glazed door

Matching Side Doors Door Order Ref. (W x H)		Horizontal	Madeley	Thame	Vertical
Imperial	Metric				
2'10" x 6'2"	875 x 1875	920	1054	1054	920
2'10" x 6'6"	875 x 2000	929	1061	1061	929
2'10" x 7'0"	875 x 2125	941	1064	1064	941
3'3" x 6'6"	1000 x 2000	969	1075	1075	969
3'3" x 7'0"	1000 x 2125	951	1084	1084	951

Matching side doors are supplied as standard with brown RAL 8014, tubular steel block frames.

Optional Extras

Novoferm Timber doors are available in the following fully finished colours:
Light Oak, Mahogany, Walnut, Burnt Oak, Ebony, Rosewood **Add £136**

Factory fitted steel fixing frames
Standard frame width 70mm. A 54mm wide frame is also available. **Please specify at time of ordering.** **Add £105**

Timber Up & Over Garage Doors (Heritage range)

Timber Up & Over Garage Doors (Heritage range)

Canopy or Retractable, unframed, with timber infill (Brown RAL8014 chassis) - manual operation.

G = Available as Glazed door

Single Doors up to 7'3"w x 6'4"h Door Order Ref. (W x H)		Tudor		Ambleside ^G		Bedale		Chatham		Dursley ^G		Edgware	
Imperial	Metric	C	R	C	R	C	R	C	R	C	R	C	R
6'6" x 6'0"	1981 x 1830	1331	1366	1337	1372	1337	1372	1337	1372	1441	1476	1672	1707
6'6" x 6'2"	1981 x 1880	1331	1366	1337	1372	1337	1372	1337	1372	1441	1476	1672	1707
6'6" x 6'3"	1981 x 1905	1331	1366	1337	1372	1337	1372	1337	1372	1441	1476	1672	1707
6'6" x 6'4"	1981 x 1930	1331	1366	1337	1372	1337	1372	1337	1372	1441	1476	1672	1707
6'6" x 6'5"	1981 x 1956	1331	1366	1337	1372	1337	1372	1337	1372	1441	1476	1672	1707
6'6" x 6'6"	1981 x 1981	1331	1366	1337	1372	1337	1372	1337	1372	1441	1476	1672	1707
6'6" x 6'9"	1981 x 2056	1331	1366	1337	1372	1337	1372	1337	1372	1441	1476	1672	1707
6'6" x 6'10"	1981 x 2083	1331	1366	1337	1372	1337	1372	1337	1372	1441	1476	1672	1707
6'6" x 6'11"	1981 x 2108	1331	1366	1337	1372	1337	1372	1337	1372	1441	1476	1672	1707
6'6" x 7'0"	1981 x 2134	1331	1366	1337	1372	1337	1372	1337	1372	1441	1476	1672	1707
6'10" x 6'0"	2083 x 1830	1376	1411	1379	1414	1379	1414	1365	1390	1474	1509	1748	1783
6'10" x 6'2"	2083 x 1880	1376	1411	1379	1414	1379	1414	1365	1390	1474	1509	1748	1783
6'10" x 6'3"	2083 x 1905	1376	1411	1379	1414	1379	1414	1365	1390	1474	1509	1748	1783
6'10" x 6'4"	2083 x 1930	1376	1411	1379	1414	1379	1414	1365	1390	1474	1509	1748	1783
6'10" x 6'5"	2083 x 1956	1376	1411	1379	1414	1379	1414	1365	1390	1474	1509	1748	1783
6'10" x 6'6"	2083 x 1981	1376	1411	1379	1414	1379	1414	1365	1390	1474	1509	1748	1783
6'10" x 6'9"	2083 x 2056	1376	1411	1379	1414	1379	1414	1365	1390	1474	1509	1748	1783
6'10" x 6'10"	2083 x 2083	1376	1411	1379	1414	1379	1414	1365	1390	1474	1509	1748	1783
6'10" x 6'11"	2083 x 2108	1376	1411	1379	1414	1379	1414	1365	1390	1474	1509	1748	1783
6'10" x 7'0"	2083 x 2134	1376	1411	1379	1414	1379	1414	1365	1390	1474	1509	1748	1783
6'11" x 6'6"	2108 x 1981	1376	1411	1379	1414	1379	1414	1365	1390	1474	1509	1748	1783
6'11" x 7'0"	2108 x 2134	1376	1411	1379	1414	1379	1414	1365	1390	1474	1509	1748	1783
7'0" x 6'2"	2134 x 1880	1410	1445	1416	1451	1403	1438	1401	1436	1503	1538	1777	1812
7'0" x 6'3"	2134 x 1905	1410	1445	1416	1451	1403	1438	1401	1436	1503	1538	1777	1812
7'0" x 6'4"	2134 x 1930	1410	1445	1416	1451	1403	1438	1401	1436	1503	1538	1777	1812
7'0" x 6'5"	2134 x 1956	1410	1445	1416	1451	1403	1438	1401	1436	1503	1538	1777	1812
7'0" x 6'6"	2134 x 1981	1268	1318	1273	1308	1273	1308	1273	1308	1356	1391	1583	1618
7'0" x 6'9"	2134 x 2056	1415	1450	1273	1308	1273	1308	1273	1308	1356	1391	1614	1649
7'0" x 6'10"	2134 x 2083	1415	1450	1273	1308	1273	1308	1273	1308	1356	1391	1614	1649
7'0" x 6'11"	2134 x 2108	1415	1450	1273	1308	1273	1308	1273	1308	1356	1391	1614	1649
7'0" x 7'0"	2134 x 2134	1300	1335	1306	1341	1306	1341	1306	1341	1378	1413	1632	1667
7'1" x 6'4"	2160 x 1930	1300	1335	1353	1388	1397	1432	1365	1400	1401	1436	1709	1744
7'1" x 6'5"	2160 x 1956	1300	1335	1353	1388	1397	1432	1365	1400	1401	1436	1709	1744
7'1" x 6'6"	2160 x 1981	1300	1335	1353	1388	1397	1432	1365	1400	1401	1436	1709	1744
7'1" x 7'0"	2160 x 2134	1300	1335	1353	1388	1397	1432	1365	1400	1401	1436	1709	1744
7'3" x 6'4"	2210 x 1930	1300	1335	1353	1388	1397	1432	1365	1400	1401	1436	1809	1844

Unframed. C = Canopy Gear, R = Retractable Gear

G = Available as Glazed door

G = Available as Glazed door

Single Doors up to 7'3"w x 6'4"h		Huntingdon ^G		Somerset ^G		Somerset ^G		Suffolk		Stirling ^G		Alford ^G		Windsor	
Imperial	Metric	C	R	C	R	C	R	C	R	C	R	C	R	C	R
6'6" x 6'0"	1667	1702	1441	1476	1488	1523	1120	1155	1441	1476	1431	1466	1331	1366	
6'6" x 6'2"	1667	1702	1441	1476	1488	1523	1120	1155	1441	1476	1431	1466	1331	1366	
6'6" x 6'3"	1667	1702	1441	1476	1488	1523	1120	1155	1441	1476	1431	1466	1331	1366	
6'6" x 6'4"	1667	1702	1441	1476	1488	1523	1120	1155	1441	1476	1431	1466	1331	1366	
6'6" x 6'5"	1667	1702	1441	1476	1488	1523	1120	1155	1441	1476	1431	1466	1331	1366	
6'6" x 6'6"	1667	1702	1441	1476	1488	1523	1120	1155	1441	1476	1431	1466	1331	1366	
6'6" x 6'9"	1667	1702	1441	1476	1488	1523	1120	1155	1441	1476	1431	1466	1331	1366	
6'6" x 6'10"	1667	1702	1441	1476	1488	1523	1120	1155	1441	1476	1431	1466	1331	1366	
6'6" x 6'11"	1667	1702	1441	1476	1488	1523	1120	1155	1441	1476	1431	1466	1331	1366	
6'6" x 7'0"	1667	1702	1441	1476	1488	1523	1120	1155	1441	1476	1431	1466	1331	1366	
6'10" x 6'0"	1709	1744	1474	1509	1542	1577	1135	1170	1474	1509	1462	1497	1376	1411	
6'10" x 6'2"	1709	1744	1474	1509	1542	1577	1135	1170	1474	1509	1462	1497	1376	1411	
6'10" x 6'3"	1709	1744	1474	1509	1542	1577	1135	1170	1474	1509	1462	1497	1376	1411	
6'10" x 6'4"	1709	1744	1474	1509	1542	1577	1135	1170	1474	1509	1462	1497	1376	1411	
6'10" x 6'5"	1709	1744	1474	1509	1542	1577	1135	1170	1474	1509	1462	1497	1376	1411	
6'10" x 6'6"	1709	1744	1474	1509	1542	1577	1135	1170	1474	1509	1462	1497	1376	1411	
6'10" x 6'9"	1709	1744	1474	1509	1542	1577	1135	1170	1474	1509	1462	1497	1376	1411	
6'10" x 6'10"	1709	1744	1474	1509	1542	1577	1135	1170	1474	1509	1462	1497	1376	1411	
6'10" x 6'11"	1709	1744	1474	1509	1542	1577	1135	1170	1474	1509	1462	1497	1376	1411	
6'10" x 7'0"	1709	1744	1474	1509	1542	1577	1135	1170	1474	1509	1462	1497	1376	1411	
6'11" x 6'6"	1709	1744	1474	1509	1542	1577	1135	1170	1474	1509	1462	1497	1376	1411	
6'11" x 7'0"	1709	1744	1474	1509	1542	1577	1135	1170	1474	1509	1462	1497	1376	1411	
7'0" x 6'2"	1768	1803	1503	1538	1619	1654	1147	1182	1503	1538	1489	1524	1410	1445	
7'0" x 6'3"	1768	1803	1503	1538	1619	1654	1147	1182	1503	1538	1489	1524	1410	1445	
7'0" x 6'4"	1768	1803	1503	1538	1619	1654	1147	1182	1503	1538	1489	1524	1410	1445	
7'0" x 6'5"	1768	1803	1503	1538	1619	1654	1147	1182	1503	1538	1489	1524	1410	1445	
7'0" x 6'6"	1583	1618	1356	1391	1391	1426	1067	1102	1356	1391	1356	1391	1268	1318	
7'0" x 6'9"	1649	1684	1356	1391	1499	1534	1067	1102	1356	1391	1356	1391	1415	1450	
7'0" x 6'10"	1649	1684	1356	1391	1499	1534	1067	1102	1356	1391	1356	1391	1415	1450	
7'0" x 6'11"	1649	1684	1356	1391	1499	1534	1067	1102	1356	1391	1356	1391	1415	1450	
7'0" x 7'0"	1632	1667	1378	1413	1416	1451	1067	1102	1378	1413	1378	1413	1300	1335	
7'1" x 6'4"	1632	1667	1401	1436	1518	1553	1067	1102	1401	1436	1405	1440	1300	1335	
7'1" x 6'5"	1632	1667	1401	1436	1518	1553	1067	1102	1401	1436	1405	1440	1300	1335	
7'1" x 6'6"	1632	1667	1401	1436	1518	1553	1067	1102	1401	1436	1405	1440	1300	1335	
7'1" x 7'0"	1632	1667	1401	1436	1518	1553	1067	1102	1401	1436	1405	1440	1300	1335	
7'3" x 6'4"	1632	1667	1401	1436	1518	1553	1067	1102	1401	1436	1405	1440	1300	1335	

Unframed. C = Canopy Gear, R = Retractable Gear

G = Available as Glazed door

Timber Up & Over Garage Doors (Heritage range continued)

Canopy or Retractable, unframed, with timber infill (Brown RAL8014 chassis) - manual operation.

G = Available as Glazed door

Single Doors 7'3" w x 6'6" h up to 8'0" w x 7'0" h Door Order Ref. (W x H)		Tudor		Ambleside ^G		Bedale		Chatham		Dursley ^G		Edgware	
Imperial	Metric	C	R	C	R	C	R	C	R	C	R	C	R
7'3" x 6'6"	2210 x 1981	1300	1335	1353	1388	1397	1432	1365	1400	1401	1436	1809	1844
7'3" x 7'0"	2210 x 2134	1300	1335	1353	1388	1397	1432	1365	1400	1401	1436	1809	1844
7'5" x 6'4"	2261 x 1930	1300	1335	1353	1388	1397	1432	1365	1400	1401	1436	1809	1844
7'5" x 6'6"	2261 x 1981	1300	1335	1353	1388	1397	1432	1365	1400	1401	1436	1809	1844
7'5" x 7'0"	2261 x 2134	1300	1335	1353	1388	1397	1432	1365	1400	1401	1436	1809	1844
7'6" x 6'4"	2286 x 1930	1300	1335	1353	1388	1397	1432	1365	1400	1401	1436	1809	1844
7'6" x 6'6"	2286 x 1981	1338	1373	1308	1343	1308	1343	1308	1343	1429	1464	1868	1903
7'6" x 7'0"	2286 x 2134	1357	1392	1336	1371	1336	1371	1336	1371	1458	1493	1867	1992
8'0" x 6'2"	2438 x 1880	1357	1392	1353	1388	1375	1410	1351	1386	1474	1509	1946	1981
8'0" x 6'3"	2438 x 1905	1357	1392	1353	1388	1375	1410	1351	1386	1474	1509	1946	1981
8'0" x 6'4"	2438 x 1930	1357	1392	1353	1388	1375	1410	1351	1386	1474	1509	1946	1981
8'0" x 6'5"	2438 x 1956	1357	1392	1353	1388	1375	1410	1351	1386	1474	1509	1946	1981
8'0" x 6'6"	2438 x 1981	1372	1407	1399	1434	1399	1434	1399	1434	1565	1600	2011	2046
8'0" x 6'9"	2438 x 2056	1372	1407	1399	1434	1399	1434	1399	1434	1565	1600	2011	2046
8'0" x 6'10"	2438 x 2083	1372	1407	1399	1434	1399	1434	1399	1434	1565	1600	2011	2046
8'0" x 6'11"	2438 x 2108	1372	1407	1399	1434	1399	1434	1399	1434	1565	1600	2011	2046
8'0" x 7'0"	2438 x 2134	1420	1455	1435	1470	1435	1470	1435	1470	1589	1624	2045	2080

Unframed. C = Canopy Gear, R = Retractable Gear

Specification

- Novoferm Up and Over garage doors are spring assisted canopy or retractable action for smooth running. The door slides up and over into the garage, providing safe and very reliable operation.
- Novoferm Up & Over garage doors can be supplied in a pre-hung factory finished steel frame, which makes installation simple and eliminates the need for a timber frame.
- Timber doors are supplied with a basecoat stain as standard. They must be finished **immediately** after installation.
- Frames are supplied as standard in brown.
- Novoferm Timber garage doors are supplied as standard with brown coloured chassis surrounding the timber panel.
- Timber doors are supplied with a door handle. If you prefer a door without a handle, you must specify when you order.
- Timber doors are bespoke and made to order.
- Please see page 46 for more details.

Timber Up & Over Garage Doors (Heritage range continued)

G = Available as Glazed door

Single Doors 7'3" w x 6'6" h	Huntingdon ^G		Somerset ^G		Somerset ^G		Suffolk		Stirling ^G		Alford ^G		Windsor	
Imperial	C	R	C	R	C	R	C	R	C	R	C	R	C	R
7'3" x 6'6"	1632	1667	1632	1667	1518	1557	1067	1102	1401	1436	1405	1405	1300	1335
7'3" x 7'0"	1632	1667	1632	1667	1518	1557	1067	1102	1401	1436	1405	1405	1300	1335
7'5" x 6'4"	1632	1667	1632	1667	1518	1557	1067	1102	1401	1436	1405	1405	1300	1335
7'5" x 6'6"	1632	1667	1632	1667	1518	1557	1067	1102	1401	1436	1405	1405	1300	1335
7'5" x 7'0"	1632	1667	1632	1667	1518	1557	1067	1102	1401	1436	1405	1405	1300	1335
7'6" x 6'4"	1632	1667	1632	1667	1518	1557	1067	1102	1401	1436	1405	1405	1300	1335
7'6" x 6'6"	1833	1868	1429	1479	1526	1561	1091	1126	1833	1883	1429	1479	1181	1231
7'6" x 7'0"	1867	1902	1458	1509	1501	1551	1091	1126	1833	1868	1458	1508	1181	1216
8'0" x 6'2"	1938	1973	1458	1493	1501	1551	1091	1126	1833	1868	1487	1522	1181	1216
8'0" x 6'3"	1938	1973	1458	1493	1501	1551	1091	1126	1833	1868	1487	1522	1181	1216
8'0" x 6'4"	1938	1973	1458	1493	1501	1551	1091	1126	1833	1868	1487	1522	1181	1216
8'0" x 6'5"	1938	1973	1458	1493	1501	1551	1091	1126	1833	1868	1487	1522	1181	1216
8'0" x 6'6"	2011	2046	1565	1615	1599	1649	1115	1150	2011	2061	1598	1633	1194	1244
8'0" x 6'9"	2011	2046	1565	1600	1599	1649	1115	1150			1598	1633		
8'0" x 6'10"	2011	2046	1565	1600	1599	1649	1115	1150			1598	1633		
8'0" x 6'11"	2011	2046	1565	1600	1599	1649	1115	1150			1598	1633		
8'0" x 7'0"	2045	2080	1589	1639	1622	1672	1115	1150	2045	2095	1648	1683	1195	1245

Unframed. C = Canopy Gear, R = Retractable Gear

Optional Extras

Novoferm Timber doors are available in the following fully finished colours:

Light Oak, Mahogany, Walnut, Burnt Oak, Ebony, Rosewood **Add £136**

Factory fitted steel fixing frames

Standard frame width 70mm. A 54mm wide frame is also available. **Please specify at time of ordering. Add £105**

Canopy or Retractable, unframed, with GRP infill (white chassis = white RAL9016, woodgrain chassis = brown RAL8014). **G** = Available as Glazed door

G = Available as Glazed door

Single Doors up to 7'6" w x 7'0" h Door Order Ref. (W x H)		Chersty G		Glossop G		Hamilton		Lydbrook G	
Imperial	Metric	C	R	C	R	C	R	C	R
6'10" x 6'4"	2083 x 1930	1447	1482	1254	1289	1418	1453	1418	1453
6'10" x 6'5"	2083 x 1956	1447	1482	1254	1289	1418	1453	1418	1453
6'10" x 6'6"	2083 x 1981	1447	1482	1254	1289	1418	1453	1418	1453
6'10" x 6'9"	2083 x 2056	1447	1482	1254	1289	1418	1453	1418	1453
6'10" x 6'10"	2083 x 2083	1447	1482	1254	1289	1418	1453	1418	1453
6'10" x 6'11"	2083 x 2108	1447	1482	1254	1289	1418	1453	1418	1453
6'10" x 7'0"	2083 x 2134	1447	1482	1254	1289	1418	1453	1418	1453
6'11" x 6'6"	2108 x 1981	1447	1482	1254	1289	1418	1453	1418	1453
6'11" x 7'0"	2108 x 2134	1447	1482	1254	1289	1418	1453	1418	1453
7'0" x 6'2"	2134 x 1880	1447	1482	1254	1289	1418	1453	1418	1453
7'0" x 6'3"	2134 x 1905	1447	1482	1254	1289	1418	1453	1418	1453
7'0" x 6'4"	2134 x 1930	1447	1482	1254	1289	1418	1453	1418	1453
7'0" x 6'5"	2134 x 1956	1447	1482	1254	1289	1418	1453	1418	1453
7'0" x 6'6"	2134 x 1981	1447	1482	1254	1289	1418	1453	1418	1453
7'0" x 6'9"	2134 x 2056	1447	1482	1254	1289	1418	1453	1418	1453
7'0" x 6'10"	2134 x 2083	1447	1482	1254	1289	1418	1453	1418	1453
7'0" x 6'11"	2134 x 2108	1447	1482	1254	1289	1418	1453	1418	1453
7'0" x 7'0"	2134 x 2134	1447	1482	1254	1289	1418	1453	1418	1453
7'1" x 6'4"	2160 x 1930	1589	1624	1327	1362	1630	1665	1630	1665
7'1" x 6'5"	2160 x 1956	1589	1624	1327	1362	1630	1665	1630	1665
7'1" x 6'6"	2160 x 1981	1589	1624	1327	1362	1630	1665	1630	1665
7'1" x 7'0"	2160 x 2134	1589	1624	1327	1362	1630	1665	1630	1665
7'3" x 6'4"	2210 x 1930	1589	1624	1327	1362	1630	1665	1630	1665
7'3" x 6'6"	2210 x 1981	1589	1624	1327	1362	1630	1665	1630	1665
7'3" x 7'0"	2210 x 2134	1589	1624	1327	1362	1630	1665	1630	1665
7'5" x 6'4"	2261 x 1930	1589	1624	1327	1362	1630	1665	1630	1665
7'5" x 6'6"	2261 x 1981	1589	1624	1327	1362	1630	1665	1630	1665
7'5" x 7'0"	2261 x 2134	1589	1624	1327	1362	1630	1665	1630	1665
7'6" x 6'4"	2286 x 1930	1589	1624	1327	1362	1630	1665	1630	1665
7'6" x 6'6"	2286 x 1981	1589	1624	1327	1362	1630	1665	1630	1665
7'6" x 7'0"	2286 x 2134	1589	1624	1327	1362	1630	1665	1630	1665

Unframed Canopy or Retractable. Factory fitted frames **Add £98**

G = Available as Glazed door

Single Doors up to 7'3" w x 6'4" h Door Order Ref. (W x H)		Newbury		Shildon G		Virginia		Winchester		Kentley	
Imperial	Metric	C	R	C	R	C	R	C	R	C	R
6'6" x 6'0"	1981 x 1830					1418	1453	1418	1453		
6'6" x 6'2"	1981 x 1880					1418	1453	1418	1453		
6'6" x 6'3"	1981 x 1905					1418	1453	1418	1453		
6'6" x 6'4"	1981 x 1930					1418	1453	1418	1453		
6'6" x 6'5"	1981 x 1956					1418	1453	1418	1453		
6'6" x 6'6"	1981 x 1981	1418	1453			1418	1453	1418	1453		
6'6" x 6'9"	1981 x 2056	1418	1453			1418	1453	1418	1453		
6'6" x 6'10"	1981 x 2083	1418	1453			1418	1453	1418	1453		
6'6" x 6'11"	1981 x 2108	1418	1453			1418	1453	1418	1453		
6'6" x 7'0"	1981 x 2134	1418	1453			1418	1453	1418	1453		
6'10" x 6'0"	2083 x 1830					1418	1453	1418	1453		
6'10" x 6'2"	2083 x 1880					1418	1453	1418	1453		
6'10" x 6'3"	2083 x 1905					1418	1453	1418	1453		
6'10" x 6'4"	2083 x 1930					1418	1453	1418	1453		
6'10" x 6'5"	2083 x 1956					1418	1453	1418	1453		
6'10" x 6'6"	2083 x 1981	1418	1453			1418	1453	1418	1453		
6'10" x 6'9"	2083 x 2056	1418	1453			1418	1453	1418	1453		
6'10" x 6'10"	2083 x 2083	1418	1453			1418	1453	1418	1453		
6'10" x 6'11"	2083 x 2108	1418	1453			1418	1453	1418	1453		
6'10" x 7'0"	2083 x 2134	1418	1453			1418	1453	1418	1453		
6'11" x 6'6"	2108 x 1981	1418	1453			1418	1453	1418	1453		
6'11" x 7'0"	2108 x 2134	1418	1453			1418	1453	1418	1453		
7'0" x 6'2"	2134 x 1880					1418	1453	1418	1453		
7'0" x 6'3"	2134 x 1905					1418	1453	1418	1453		
7'0" x 6'4"	2134 x 1930					1418	1453	1418	1453		
7'0" x 6'5"	2134 x 1956					1418	1453	1418	1453		
7'0" x 6'6"	2134 x 1981	1418	1453	1681	1716	1418	1453	1418	1453		
7'0" x 6'9"	2134 x 2056	1418	1453	1681	1716	1418	1453	1418	1453		
7'0" x 6'10"	2134 x 2083	1418	1453	1681	1716	1418	1453	1418	1453	1418	1453
7'0" x 6'11"	2134 x 2108	1418	1453	1681	1716	1418	1453	1418	1453	1418	1453
7'0" x 7'0"	2134 x 2134	1418	1453	1681	1716	1418	1453	1418	1453	1418	1453
7'1" x 6'4"	2160 x 1930					1630	1665	1630	1665		
7'1" x 6'5"	2160 x 1956					1630	1665	1630	1665		
7'1" x 6'6"	2160 x 1981	1630	1665			1630	1665	1630	1665		
7'1" x 7'0"	2160 x 2134	1630	1665			1630	1665	1630	1665	1630	1665
7'3" x 6'4"	2210 x 1930					1630	1665	1630	1665		

Unframed Canopy or Retractable. Factory fitted frames **Add £98**

G = Available as Glazed door

Canopy or Retractable, unframed, with GRP infill (white chassis = white RAL9016, woodgrain chassis = brown RAL8014). **G** = Available as Glazed door

G = Available as Glazed door

Single Doors 8'0" w x 6'4" h up to 8'0" w x 7'0" h Door Order Ref. (W x H)		Cherstsy G		Glossop G		Hamilton		Lydbrook G	
Imperial	Metric	C	R	C	R	C	R	C	R
8'0" x 6'4"	2438 x 1930	1643	1678	1380	1415	1683	1718	1683	1718
8'0" x 6'5"	2438 x 1956	1643	1678	1380	1415	1683	1718	1683	1718
8'0" x 6'6"	2438 x 1981	1643	1678	1380	1415	1683	1718	1683	1718
8'0" x 6'9"	2438 x 2056	1643	1678	1380	1415	1683	1718	1683	1718
8'0" x 6'10"	2438 x 2083	1643	1678	1380	1415	1683	1718	1683	1718
8'0" x 6'11"	2438 x 2108	1643	1678	1380	1415	1683	1718	1683	1718
8'0" x 7'0"	2438 x 2134	1643	1678	1380	1415	1683	1718	1683	1718

Unframed Canopy or Retractable. Factory fitted frames **Add £98** **G** = Available as Glazed door

Specification

- Novoferm Up and Over garage doors are spring assisted canopy or retractable action for smooth running. The door slides up and over into the garage, providing safe and very reliable operation.
- Novoferm Up & Over garage doors can be supplied in a pre-hung factory finished steel fixing frame, which makes installation simple and eliminates the need for a timber frame which can warp or rot over time. These frames are supplied as standard in white, however colour matched frames are also available (please see the Optional Extras section).
- Factory fitted canopy frames are 54mm wide as standard. Retractable frames are 70mm.
- All Up & Over garage doors are supplied with our black "D" handle (see page 22 in the Novoferm brochure).

Woodgrain Colours: White, Magnolia, Bleached Oak, Red Mahogany, Light Oak, Dark Oak, Honey Beech, Teak, Rosewood, Golden Brown, Dark Mahogany, Ebony.

Woodgrain colour options at additional cost:

Blue, Red, Green, Anthracite Grey **Add £200**
RAL colour of your choice **Add £250**

High Gloss Colours: Gloss White and Gloss Magnolia.

Window glazing options

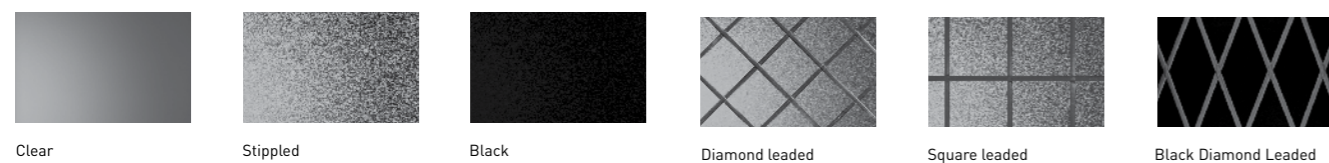

Clear Stippled Black Diamond leaded Square leaded Black Diamond Leaded

Single Doors 7'3" w x 6'6" h up to 8'0" w x 7'0" h Door Order Ref. (W x H)		Newbury		Shildon G		Virginia		Winchester		Kentley	
Imperial	Metric	C	R	C	R	C	R	C	R	C	R
7'3" x 6'6"	2210 x 1981	1630	1665	1720	1755	1630	1665	1630	1665		
7'3" x 7'0"	2210 x 2134	1630	1665	1720	1755	1630	1665	1630	1665	1630	1665
7'5" x 6'4"	2261 x 1930					1630	1665	1630	1665		
7'5" x 6'6"	2261 x 1981	1630	1665	1720	1755	1630	1665	1630	1665		
7'5" x 7'0"	2261 x 2134	1630	1665	1720	1755	1630	1665	1630	1665	1630	1665
7'6" x 6'4"	2286 x 1930					1630	1665	1630	1665		
7'6" x 6'6"	2286 x 1981	1630	1665	1720	1755	1630	1665	1630	1665		
7'6" x 7'0"	2286 x 2134	1630	1665	1720	1755	1630	1665	1630	1665	1630	1665
8'0" x 6'2"	2438 x 1880					1683	1718				
8'0" x 6'3"	2438 x 1905					1683	1718				
8'0" x 6'4"	2438 x 1930					1683	1718				
8'0" x 6'5v	2438 x 1956					1683	1718				
8'0" x 6'6"	2438 x 1981			1771	1806	1683	1718				
8'0" x 6'9"	2438 x 2056			1771	1806	1683	1718				
8'0" x 6'10"	2438 x 2083			1771	1806	1683	1718			1683	1718
8'0" x 6'11"	2438 x 2108			1771	1806	1683	1718			1683	1718
8'0" x 7'0"	2438 x 2134			1771	1806	1683	1718			1683	1718

Unframed Canopy or Retractable. Factory fitted frames **Add £98** **G** = Available as Glazed door

Optional Extras

Factory fitted steel fixing frame **Add £105**
Bottom rubber weatherseal 8ft/10ft **Add £62/£84**
Doors not drilled for lock handle **No cost option**

Automated doors only

Novomatic 553 NRG Operator **£485**
Additional Micro two channel remote control handset **£57**
Additional Mini two channel remote control handset **£57**
Additional Mini four channel remote control handset **£60**

Glazing

Cherstsy & Shildon Black as price list
Glossop & Lydbrook with Black Windows **add £150.00**
Glossop & Lydbrook with Clear or stippled with Diamond or square lattice **add £300.00**
Cherstsy with Clear or stippled windows **add £340.00**
Shildon with Clear or stippled windows **add £400.00**

GRP doors are bespoke and made to order.

Automated operation, insulated aluminium roller garage doors. Compliant with EN12453 - Safety in use of powered doors

Novoroll 77 **NEW SIZES**

Polyester Paint Finish

Available in following colours: White RAL9016, Mocca Brown RAL8019, Black RAL9011, Burgundy RAL3004, Racing Green RAL6009, Blue RAL5011, Beige RAL1019, Brown RAL8014, Anthracite Grey RAL7016, Golden Oak, Rosewood.

Guide Height (up to)		Overguide Width (up to)						
Imperial	Metric	6'6" (1981mm)	8'2" (2500mm)	9'10" (3000mm)	11'5" (3500mm)	13'0" (4000mm)	15'0" (4600mm)	17'0" (5000mm)
6'6"	1981mm	1353	1444	1587	1718	1857	2082	2399
7'0"	2134mm	1364	1455	1603	1723	1903	2127	2409
7'6"	2286mm	1395	1486	1629	1748	2050	2195	2530
8'0"	2438mm	1422	1513	1684	1773	2066	2263	2546
8'6"	2591mm	1527	1670	1797	1888	2228	2413	2750
9'0"	2700mm	1548	1681	1808	1897	2265	2644	2882

Textured Woodgrain Finish **NEW SIZES**

Available in following colours: Black, Anthracite Grey, Golden Oak, Wine Red, Rosewood, Moss Green, Mahogany, Steel Blue, Dark Red.

Guide Height (up to)		Overguide Width (up to)						
Imperial	Metric	6'6" (1981mm)	8'2" (2500mm)	9'10" (3000mm)	11'5" (3500mm)	13'0" (4000mm)	15'0" (4600mm)	17'0" (5000mm)
6'6"	1981mm	1506	1524	1650	1738	1913	2138	2647
7'0"	2134mm	1531	1544	1689	1779	1960	2184	2767
7'6"	2286mm	1578	1589	1721	1798	2123	2290	2845
8'0"	2438mm	1609	1624	1741	1830	2245	2399	2899
8'6"	2591mm	1844	1970	2105	2315	2655	2955	3190
9'0"	2700mm	1954	1980	2115	2330	2705	2960	3540

Specification

- Novoroll 77 is supplied as standard with the following: White polyester painted 90mm guides, White 300mm Novoshield Full box, Novoroll hard wired control safety system, 2no 2-channel hand transmitters.

Optional Extras

 NovoShield Box in any of the standard colours above	Per linear metre Add £42	Wireless key switch (signal 512)	Add £126
90mm Guide rails in any of the standard colours above	Per pair Add £43	Standard wireless keypad (signal 214)	Add £171
Low level emergency release kit	Add £138	Standard wireless keypad (signal 215)	Add £223
Internal up/down switch (signal 107)	Add £22	Hand transmitters (2 channel mini/micro)	Add £60
Vision Lath NEW	Add £32/m	Hand transmitters (4 channel mini)	Add £63
Vents for lath NEW	Add £28/m		



Novoroll 55 **NEW**

Polyester Paint Finish

Available in following colours: White RAL9016, Mocca Brown RAL8019, Black RAL9011, Burgundy RAL3004, Racing Green RAL6009, Blue RAL5011, Brown RAL8014, Anthracite Grey RAL7016, Cream RAL 9001, Golden Oak.

Guide Height (up to)		Overguide Width (up to)		
Imperial	Metric	6'6" (1981mm)	8'2" (2500mm)	9'10" (3000mm)
6'6"	1981mm	1299	1365	1430
7'0"	2134mm	1320	1342	1494
7'6"	2286mm	1382	1467	1591
8'0"	2438mm	1556	1598	1699

Textured Woodgrain Finish **NEW**

Available in following colours: Golden Oak, Rosewood.

Guide Height (up to)		Overguide Width (up to)		
Imperial	Metric	6'6" (1981mm)	8'2" (2500mm)	9'10" (3000mm)
6'6"	1981mm	1541	1638	1905
7'0"	2134mm	1541	1661	1985
7'6"	2286mm	1749	1698	2015
8'0"	2438mm	1765	1812	2005

Specification **NEW**

- Novoroll 55 is supplied as standard with the following: White 65mm guides as standard, White 205mm Novoshield full box, Novoroll hard wired control safety system, 2 no 2-channel hand transmitters.

Optional Extras **NEW**

 NovoShield Box in any of the standard colours above	Per linear metre Add £42
65mm Guide rails in any of the standard colours above	Per pair Add £43
Low level emergency release kit	Add £138
Internal up/down switch (signal 107)	Add £22
Wireless key switch (signal 512)	Add £126
Standard wireless keypad (signal 214)	Add £171
Standard wireless keypad (signal 215)	Add £223
Hand transmitters (2 channel mini/micro)	Add £60
Hand transmitters (4 channel mini)	Add £63





Novoroll Personnel Door **NEW**

Door opening size

From 2'6" to 3'6" wide x 6' to 6'6" high	£847
From 3'6" to 4'0" wide x 6'6" to 7'6" high	£985

Specification

- Each door panel can be made from 77mm or 55mm aluminium insulated lath
- Each door includes a 65mm x 68mm steel frame
- Colours available are shown in the Novoroll door section. Laminated door panels will be supplied with brown outer frame
- A Yale type lock is supplied as standard
- Please specify which handing the door panel is to be
- Outside looking inwards
- Roller doors are bespoke and made to order

	Novomatic 553NRG [†]	Novomatic 553B [†] (includes battery back-up and transmitter)	Novomatic 803 [†]	NovoPort ^{®†}
Boom Length				
	1 Piece Belt	1 Piece Belt	1 Piece Belt	
To suit doors up to 2125mm*	485	709	702	380
[†] Available for Side Sectional doors price £925. *Greater boom lengths are available, however for door heights above 2250mm we recommend NovoPort				

Novomatic 803(1000N)

- 24V DC-motor, 230V-240V/50Hz, 450watt
- Maximum push/pull force 1000N
- Max running speed 17 cm/sec
- Soft start/stop
- 7-segment display menu guided control with diagnostic display
- Digital remote control 433MHz with Keeloq rolling code
- 40W integrated LED lighting
- Standby power 4W
- Electrically monitored anti-opening security device
- Suitable for residential doors up to 15m², max door height (front mount 2375mm, rear mount 2250mm)
- Supplied as: Motor head, 3 part C-profile channel with toothed belt and two 2 channel handsets
- Available with temporary battery back-up operation (803B)

Novomatic 553NRG(700N)

- 24V DC-motor, 230V-240V/50Hz, 280watt
- Maximum push/pull force 700N
- Max running speed 22 cm/sec opening, 17 cm/sec closing.
- Soft start/stop
- 7-segment display menu guided control with diagnostic display
- Digital remote control 433MHz with Keeloq rolling code
- 40W integrated LED lighting
- Standby power 0.5W
- Electrically monitored anti-opening security device
- Suitable for residential doors up to 15m², max door height (front mount 2375mm) (rear mount 2250mm)
- Supplied as: Motor head, 1 part C-profile channel with toothed belt and two 2 channel handsets
- Available with temporary battery back-up operation (553B)

Power Operated Garage Doors

It is against the law to install a power operated garage door in the UK without complying with The Machinery Directive.

To comply with the Machinery Directive both the door and the operator used in the Installation **must** have a declaration of Incorporation from the manufacturer.

On completion of the installation the Installer must provide a Declaration of conformity and apply a CE mark giving details of the installation (as example) to the door / operator combination, which is now classed as a machine.

The Installer must issue to the Customer a declaration of conformity on the completion of the installation.

The Installer must hold copies of both the Declarations of Incorporation and the Declaration of Conformity on a technical file for inspection by the relevant authorities.

If any of the above requirements are not fulfilled the Installation is illegal.

Please ensure for your own safety and peace of mind that whoever installs your electric operator is both willing and able to fulfil these requirements; if they are not - do not use them!!

Members of the DHF Garage Door Group CAN and WILL install your Novoferm operator safely and legally.



DHF Information

Types of garage door

Garage doors are available in a variety of different styles but also come fitted with operating systems to suit various applications. Here are some of the more common types of garage door:

Canopy up and over

Ideally suited where either economy is a factor or in situations where the door cannot intrude fully into the garage due to obstructions such as soil pipes, gas meters or doors that open into the garage from the house. Approximately one third of the door extends forward of the frame to form a canopy. In some circumstances these may be suitable for automation but more expensive to adapt from manual spring operation.

Retractable up and over

This is becoming increasingly popular as automation can be easily added without expensive conversion. Also unlike the canopy door, which is reliant on cables to assist opening, retractable doors use side mounted spring assisted lifting arms. Being more substantial, these rarely require replacement. The entire door retracts back into the garage on most makes.

Sectional overhead

The principal benefit of a sectional overhead door compared with an up and over door is that it does not swing out when opening or closing. The whole door is divided horizontally into four or more panels that run on rollers in vertical tracks that then turn 90 degrees at the top into horizontal tracks that follow the roofline. This is ideal for automation and low on maintenance.

Roller shutter

Individual horizontal slats constructed from either steel or aluminium are linked together to form a tightly coiling curtain which rolls up around a shaft located above the door opening. These doors do not swing out during operation. They are usually fitted behind the structural opening to maximise width and height when open. They are usually supplied ready motorised. Other types are available made from a castellated sheet that forms the panel.













Round the corner









Historically one of the earliest types of garage door operation. The door, usually made from timber panels, slides sideways on an overhead track and bottom guide rail and then turns through 90 degrees to follow the wall back into the garage. Larger doors can be supplied as bi-parting, where two separate doors slide in opposite directions. This is an ideal solution to low headroom problems, as they do not swing out. They can be automated.

Side hinged

The original type of garage door fitted before the advent of the up and over door. The doors hinge outwards making them ideal for garages that are used for everything except the car because only one leaf of the pair has to be opened. Some makes offer a one-third/two-thirds split for each leaf, so reducing the size of the pedestrian access door. Side hinged doors are easily automated.

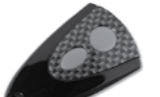

Images not to scale.	Accessory	Novomatic compatible	NovoPort compatible	Price
	Wall Switches Signal107, 1-channel. Supplied with a 7m cable	•	•	22
	Key Switch Signal 313, flush-mounted, double switch pulse, incl. cylinder 40.5mm long, division 30.5/10mm, lever 180°	•	•	58
	Key Switch Signal 413, surface-mounted, double switch pulse, incl. cylinder 40.5mm long, division 30.5/10mm, lever 180°	•	•	58
	Remote Key Switch Signal 512, flush-mounted, single switch pulse, incl. cylinder 40.5mm long, division 30.5/10mm, lever 180°	•	•	126
	Remote Code Keypad Signal 217, membrane faced key pad, surface-mounted (3 signals) (wireless)	•	•	171
	Remote Code Keypad Signal 218, metal faced key pad, surface-mounted (3 signals) (wireless)	•	•	226
	Wireless Push Button (111)	•	•	68
	Push Button (112) with safe lock switch and courtesy light button	•	•	53
	Telescopic operator bracket for all Novoferm sectional garage doors	•		50
	Emergency Unlocking Extra 304, Novoferm sectional garage doors	•	•	50
	Emergency Unlocking Extra 305, Novoferm round-cylinder sectional garage doors	•	•	50
	Emergency Unlocking Extra 312, Novoferm up&over garage doors	•		47
	Bolting Set Extra 203, in the middle, up&over garage doors for extra security	•		50

Images not to scale.	Accessory	Novomatic compatible	NovoPort compatible	Price
	External Radio Receiver E43-U, 1-channel, 12-24V, 433MHz Allows Novoferm handsets to be used on additional operators. eg gates, lights etc.	•	•	80
	Photocell sensor Extra 615, 24V AC/DC, IP 45	•	•	83
	NEW Photocell sensor Compatible with Novomatic 553NRG	•		83
	Wicket door contact Extra 412, Novoferm up&over garage doors	•		91
	LED Lighting Kit Up to 3000mm door width	•	•	497
	LED Lighting Kit Up to 4000mm door width	•	•	558
	LED Lighting Kit Up to 5000mm door width	•	•	767
	Punched Angle 5ft length	•	•	14
	Mini Hand Transmitter Novotron 502, 2-channel Novotron 512, 2-channel	•	•	53.50
	Mini Hand Transmitter Novotron 504, 4-channel	•	•	53.50
	Micro Hand Transmitter Novotron 512, 2-channel Balck fnish with carbon inlay	•	•	71.50
	Novotron Handset clip for 502/504			6.50

Door height			=H1+50	=H1-20	=H1-90				
imp	mm	H1	H2	H3	H4	H5	H6	R	C
6'4"	1931	1931	1981	1911	1841	1300	49	675	625
6'6"	1981	1981	2031	1961	1891	1300	49	725	657
6'10"	2085	2085	2135	2065	1995	1300	49	825	775
7'0"	2134	2134	2184	2114	2044	1300	49	880	825

H1 = Internal Frame Height

H2 = Minimum Height from floor to underside of ceiling

H3 = Minimum Brickwork Opening Height

H4 = Clear Drive Through Height (Internal Hand le is the lowest point)

H5 = How far the door extends into the garage from the back of the brickwork opening

H6 = Kick Up (The height above the Internal Frame Height the door panel rises during the opening cycle)

R = The Arc of travel of the bottom edge of the door

C = The canopy (How far the door protrudes from the frame front)

Note:- The Kick up is greater than the frame Lintel Height and peeks above the Lintel at 1100mm into the garage from the frame front

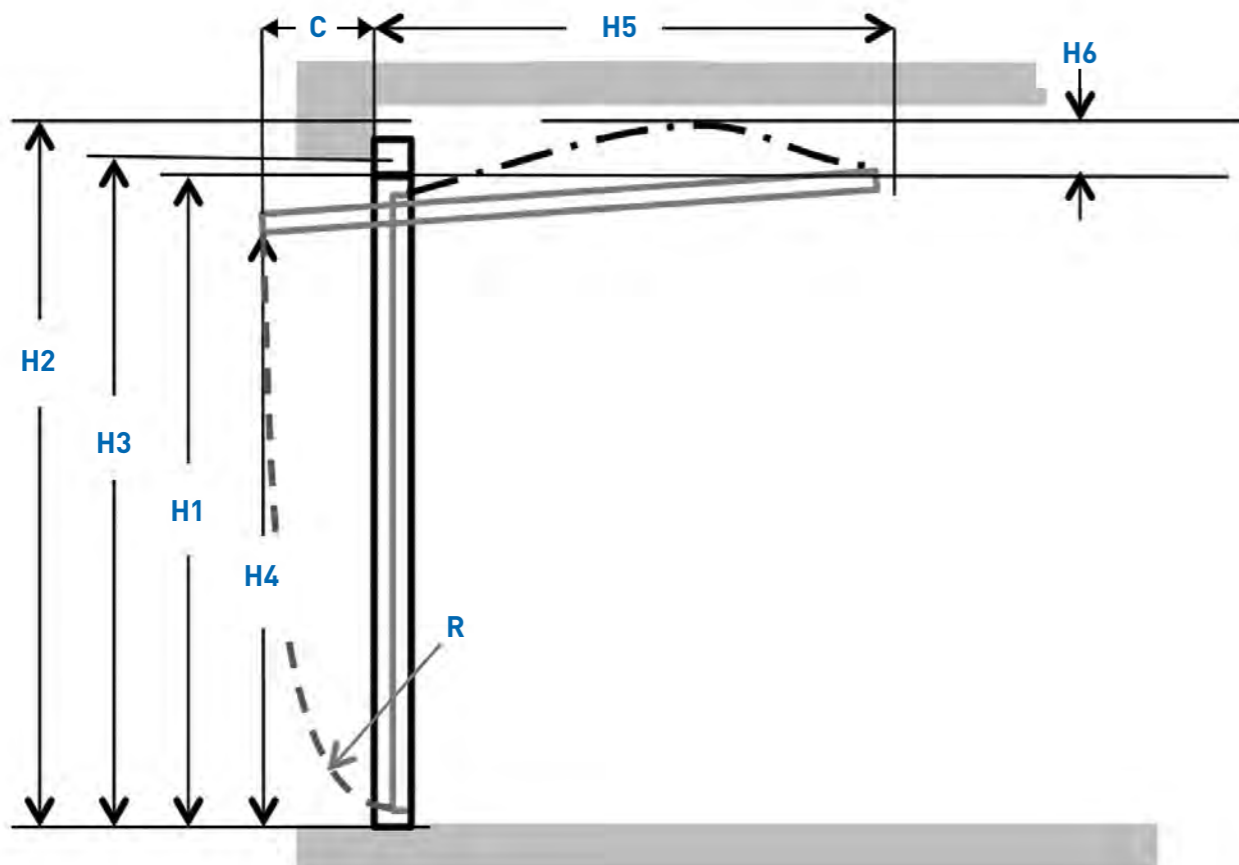

Door width		Common dimensions			54mm wide frame	70mm wide frame
imp	mm	W1	W2	W3	W4	W4
6'10"	2085	2085	2193	2109	2199	2231
7'0"	2134	2125	2233	2149	2239	2271
7'3"	2210	2210	2318	2234	2324	2356
7'5"	2261	2261	2369	2285	2375	2407
7'6"	2286	2286	2394	2310	2400	2432
8'0"	2438	2440	2548	2548	2554	2586

W1 = Internal Frame Width
 W2 = Overall Frame Size Width
 W3 = Minimum Brickwork Opening (fitting behind)
 W4 = Recommended Brickwork Opening Width

Fitting behind the opening

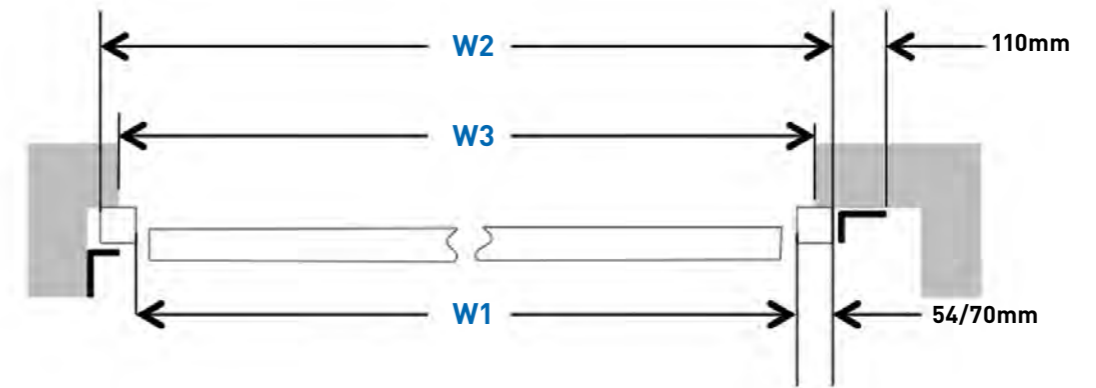

Fitting within the opening

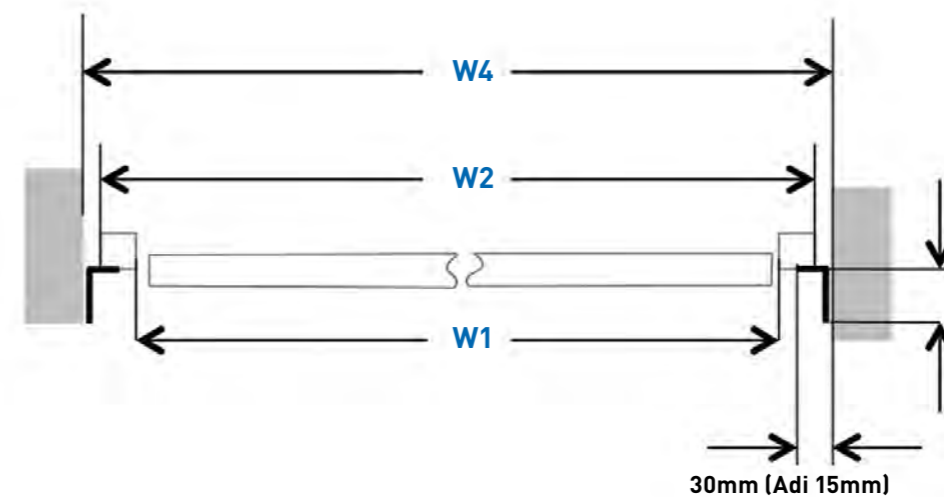

Up and Over Garage Doors. Single Retractable Gear Type

Door height			=H1+45	=H1-20	=H1-90			
imp	mm	H1	H2	H3	H4	H5	R	C
6'6"	1981	1981	2025	1961	1860	1735	750	225
7'0"	2134	2134	2180	2114	2010	1890	870	265

- H1 = Internal Frame Height
- H2 = External Frame Height
- H3 = Minimum Brickwork Opening Height
- H4 = Clear Drive Through Height (internal handle is the lowest point)
- H5 = How far the door extends into the garage
- R = The arc of travel of the bottom edge of the door
- C = The canopy (how far the door protrudes from the frame front)

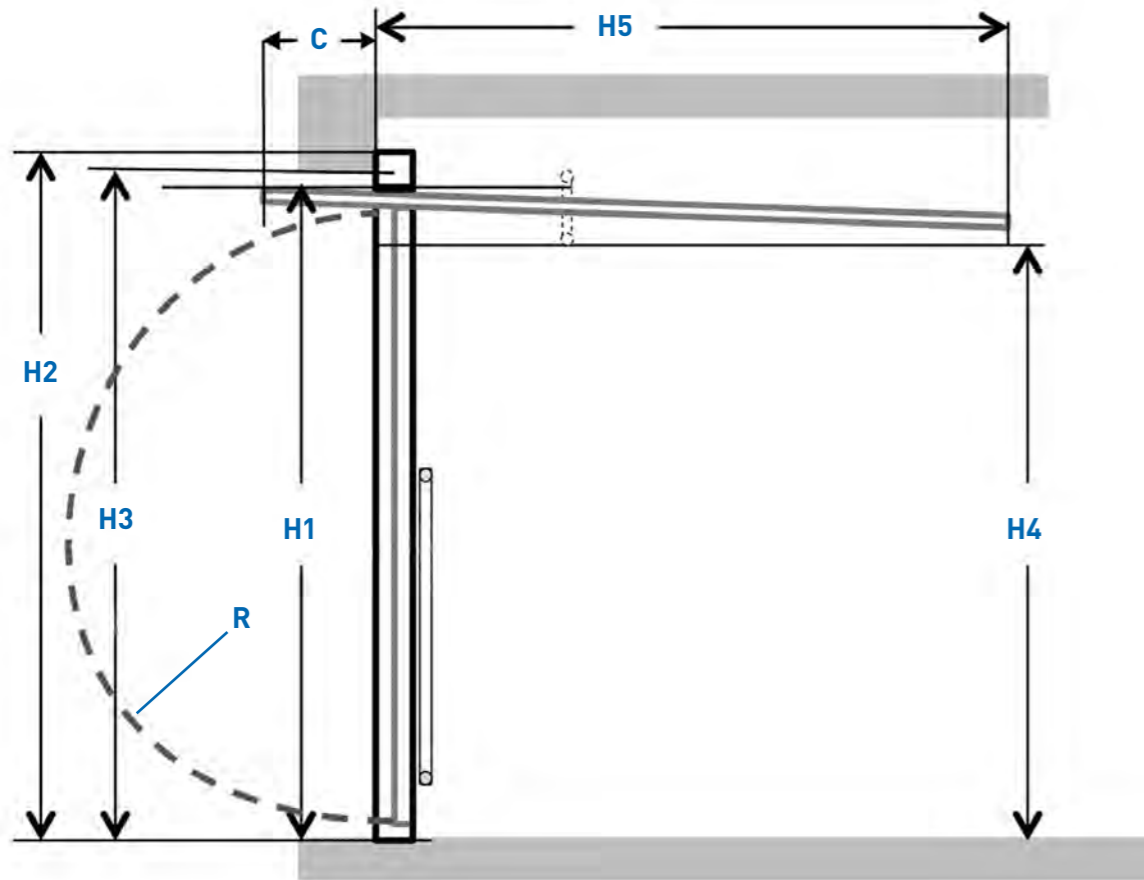

Up and Over Garage Doors. Single Retractable Gear Type

Door width		common dimensions				70mm wide frame	
imp	mm	W1	W2	W3A	W3B	W4	W5
6'10"	2085	2085	2109	1985	2049	2225	2245
7'0"	2134	2134	2158	2034	2098	2274	2294
7'3"	2210	2210	2234	2110	2174	2350	2370
7'5"	2261	2261	2285	2161	2225	2381	2421
7'6"	2286	2286	2310	2186	2250	2426	2446
8'0"	2438	2438	2462	2338	2402	2580	2598

- W1 = Internal Frame Width
- W2 = Minimum Brickwork Opening (fitting behind)
- W3A = Clear Drive through Width - Above the Crank of the Pivot Arm
- W3B = Clear Drive through Width - Below the Crank of the Pivot Arm
- W4 = External Frame Width
- W5 = Recommended Brickwork Opening Width (fitting between)

NOTE - The crank in the pivot arm is
 1000mm from the floor on a 1981mm high door
 1100mm from the floor on a 2134mm high door

Fitting behind the opening

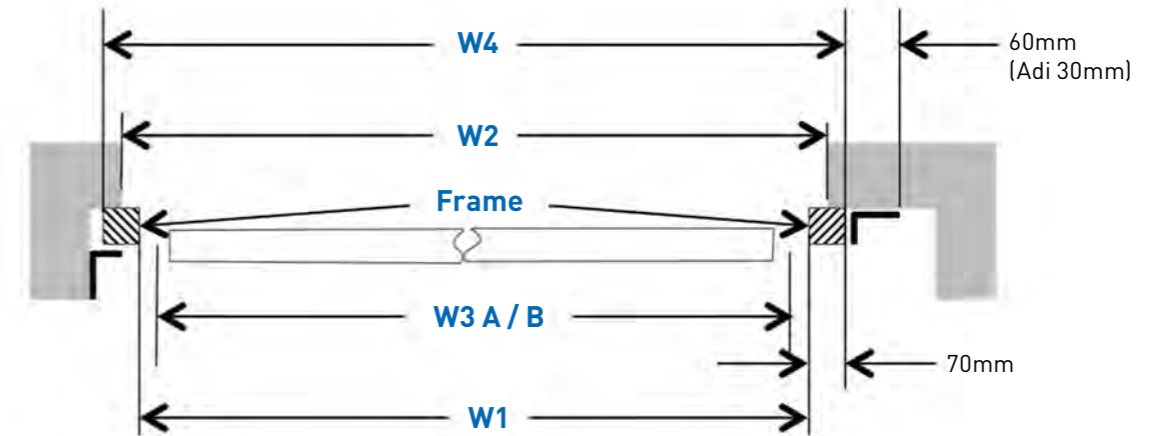

Fitting within the opening

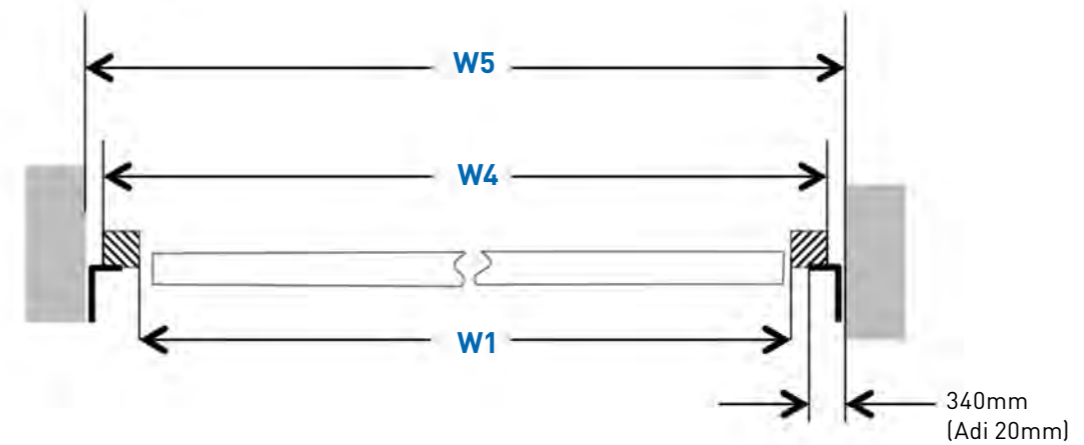

Standard size heights

Order ref height	Standard size heights			
	M1	M2	M3	M4
6'4"	1925	2045	2050	2690
6'6"	2000	2120	2125	2765
6'10"	2075	2195	2200	2840
7'0"	2125	2245	2250	2890

CPH Clear Passage Height (with NovoPort)

COH (M1) Co-ord Height

OFH (M2) Outer Frame Height

CH (M3) min. Ceiling Height

ID (M4) min. Installation Depth

Special size heights iso20 and iso45 doors

Order ref height M1	ISO20			ISO45 front mount			iso45 rear mount		
	M2	M3	M4	M2	M3	M4	M2	M3	M4
1875	1985	1995	2640	2083	2090	2580	1985	1990	2760
2000	2110	2120	2765	2208	2215	2580	2110	2115	2760
2125	2235	2245	2890	2333	2340	2705	2235	2240	2885
2250	2360	2370	3015	2458	2465	2830	2360	2365	3010
2375	2485	2495	2140	2683	2590	2955	2485	2490	3135
2500	2610	2620	3265	2708	2715	3080	2610	2615	3260
2625	2735	2745	3390	2833	2840	3330	2735	2740	3510
2750	2860	2870	3515	2958	2965	3330	2860	2865	3510
2875	-	-	-	3083	3090	3455	2985	2990	3635
3000	-	-	-	3208	3215	3580	3110	3115	3760
3125	-	-	-	3333	3340	3705	3235	3240	3885

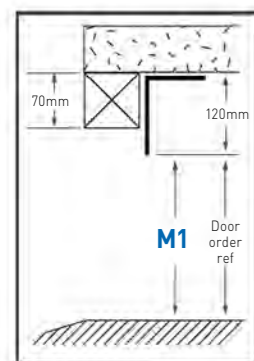
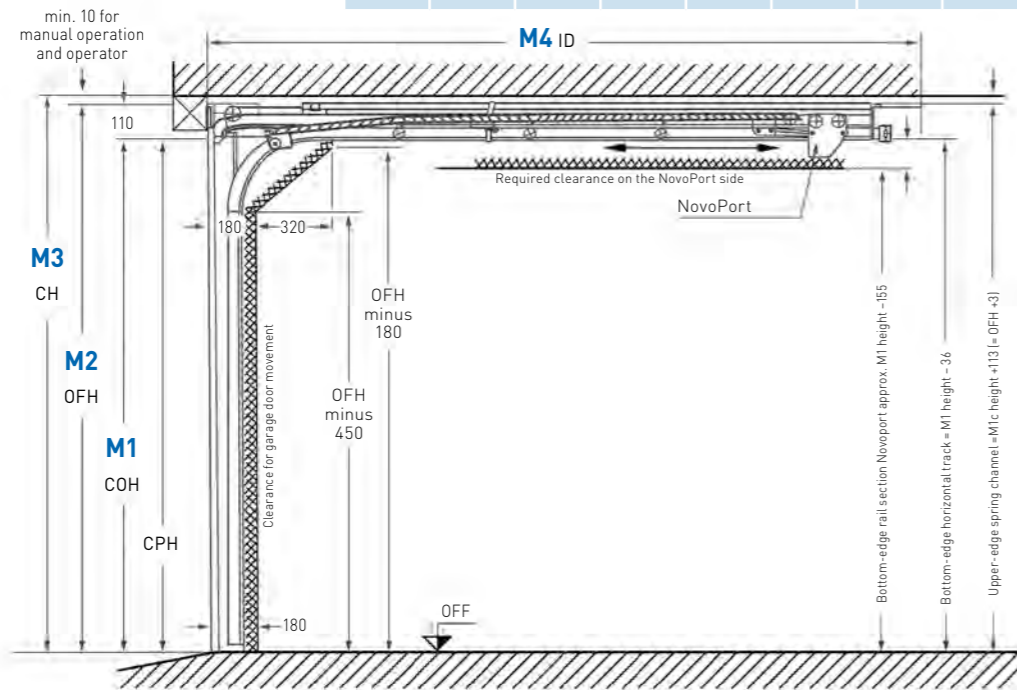

Fitting within the opening

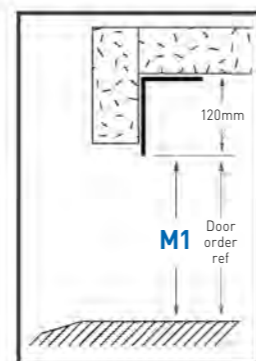
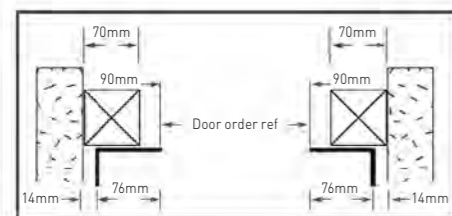

Fitting behind the opening

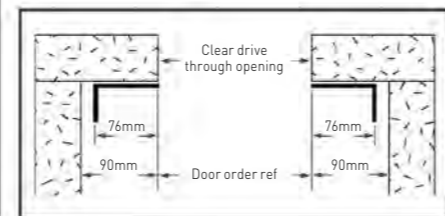

Ordering information

To calculate the correct door order size to fit within a structural opening, deduct 180mm from the width and 120mm (rear mount) or 215mm (front mount) from the height. For behind the reveal fit calculate from drawings (using required headroom for front/rear mount).

Rear mounted torsion spring shaft

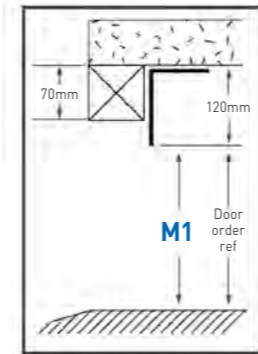

Fitting within the opening

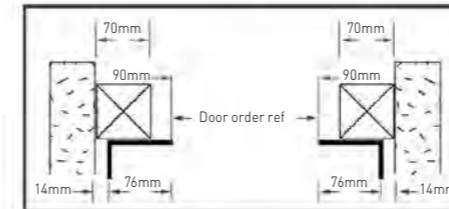

Order ref height	Standard size heights			
	M1	M2	M3	M4
6'4"	1925	2045	2050	2690
6'6"	2000	2120	2125	2765
6'10"	2075	2195	2200	2840
7'0"	2125	2245	2250	2890

Front mounted torsion spring shaft

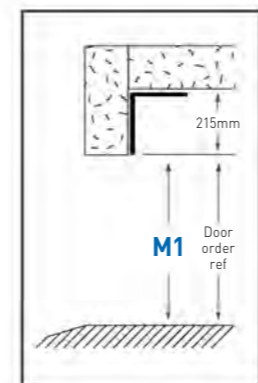

Fitting behind the opening

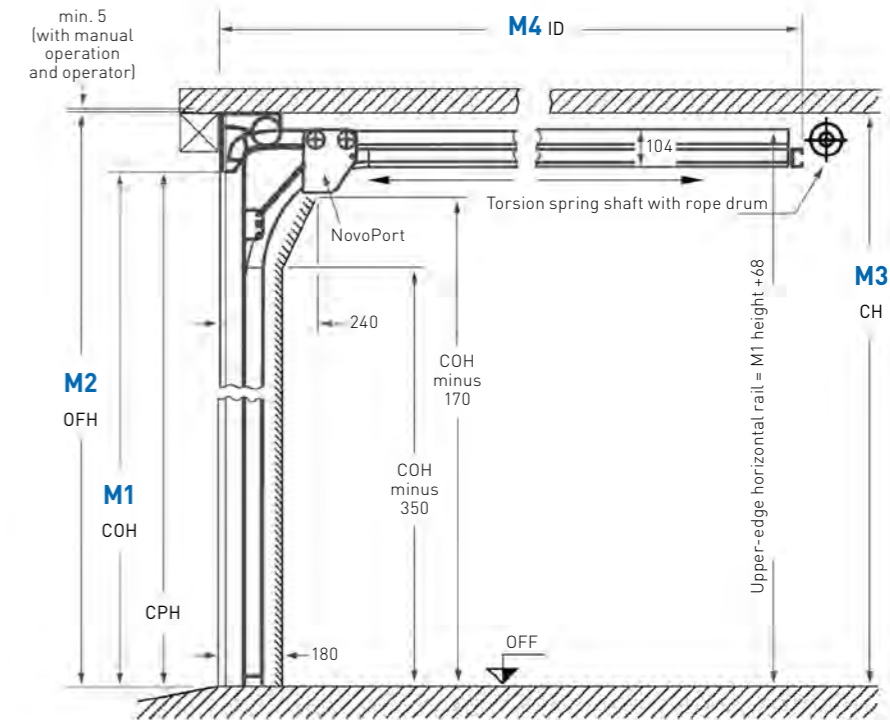
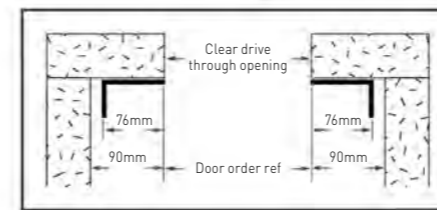

CPH Clear Passage Height (with NovoPort)

COH (M1) Co-ord Height

OFH (M2) Outer Frame Height

CH (M3) min. Ceiling Height

ID (M4) min. Installation Depth

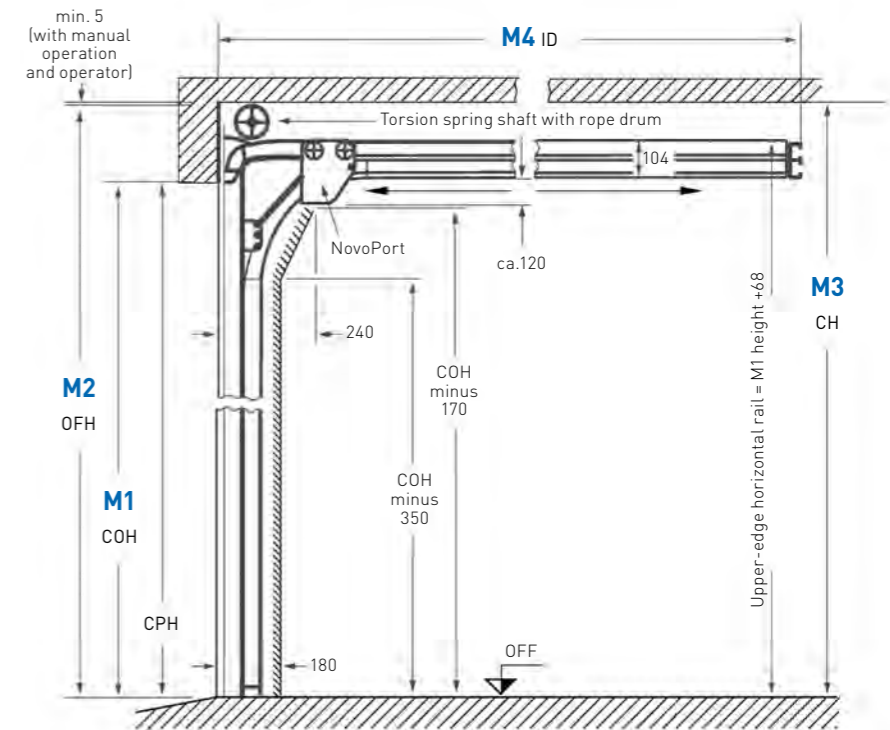

Order ref height	Standard size heights			
	M1	M2	M3	M4
6'4"	1925	2140	2145	2505
6'6"	2000	2215	2220	2580
6'10"	2075	2290	2295	2655
7'0"	2125	2340	2345	2705

CPH Clear Passage Height (with NovoPort)
COH (M1) Co-ord Height
OFH (M2) Outer Frame Height
CH (M3) min. Ceiling Height
ID (M4) min. Installation Depth

Lateral cross section

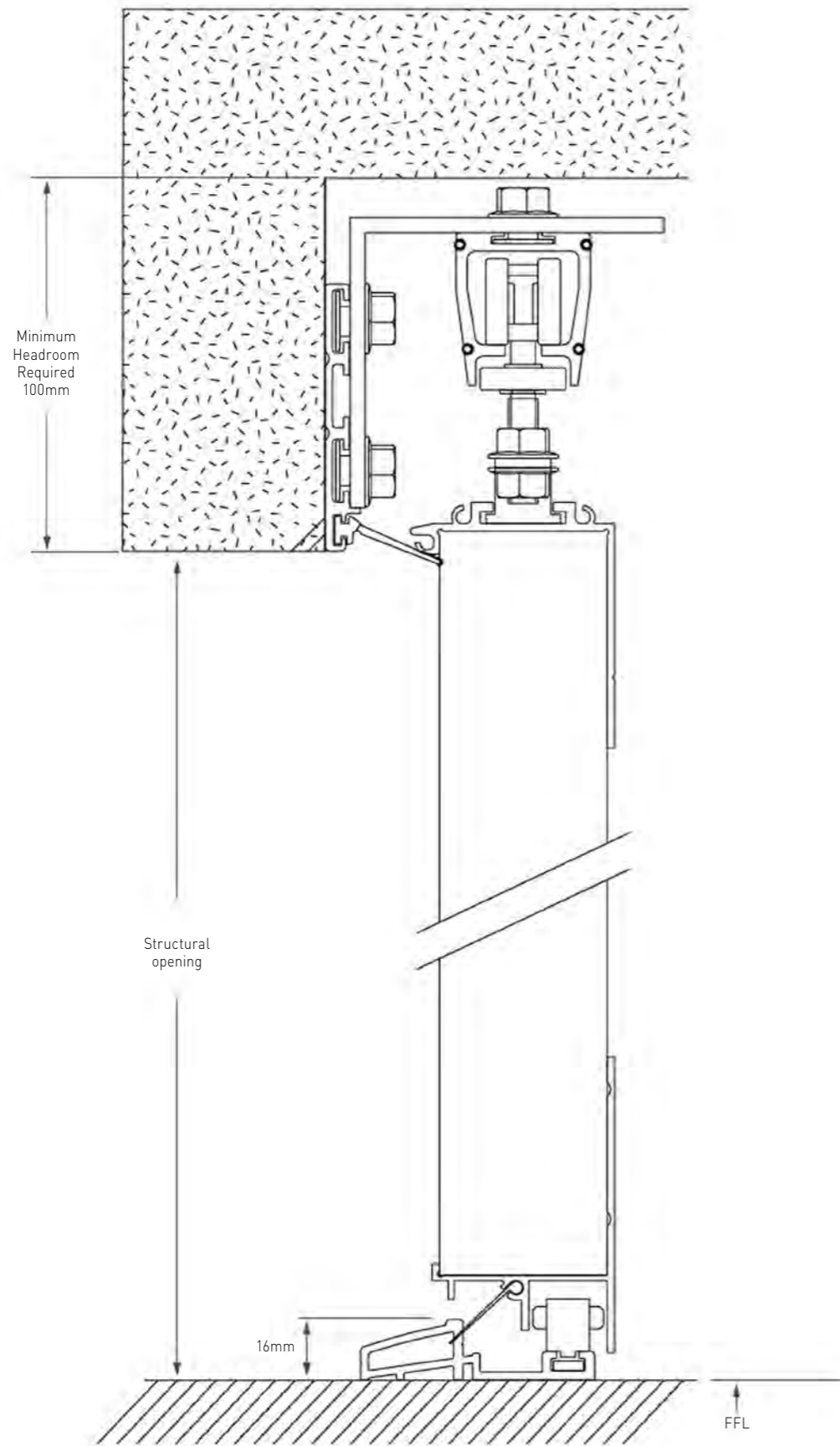

Installation dimensions

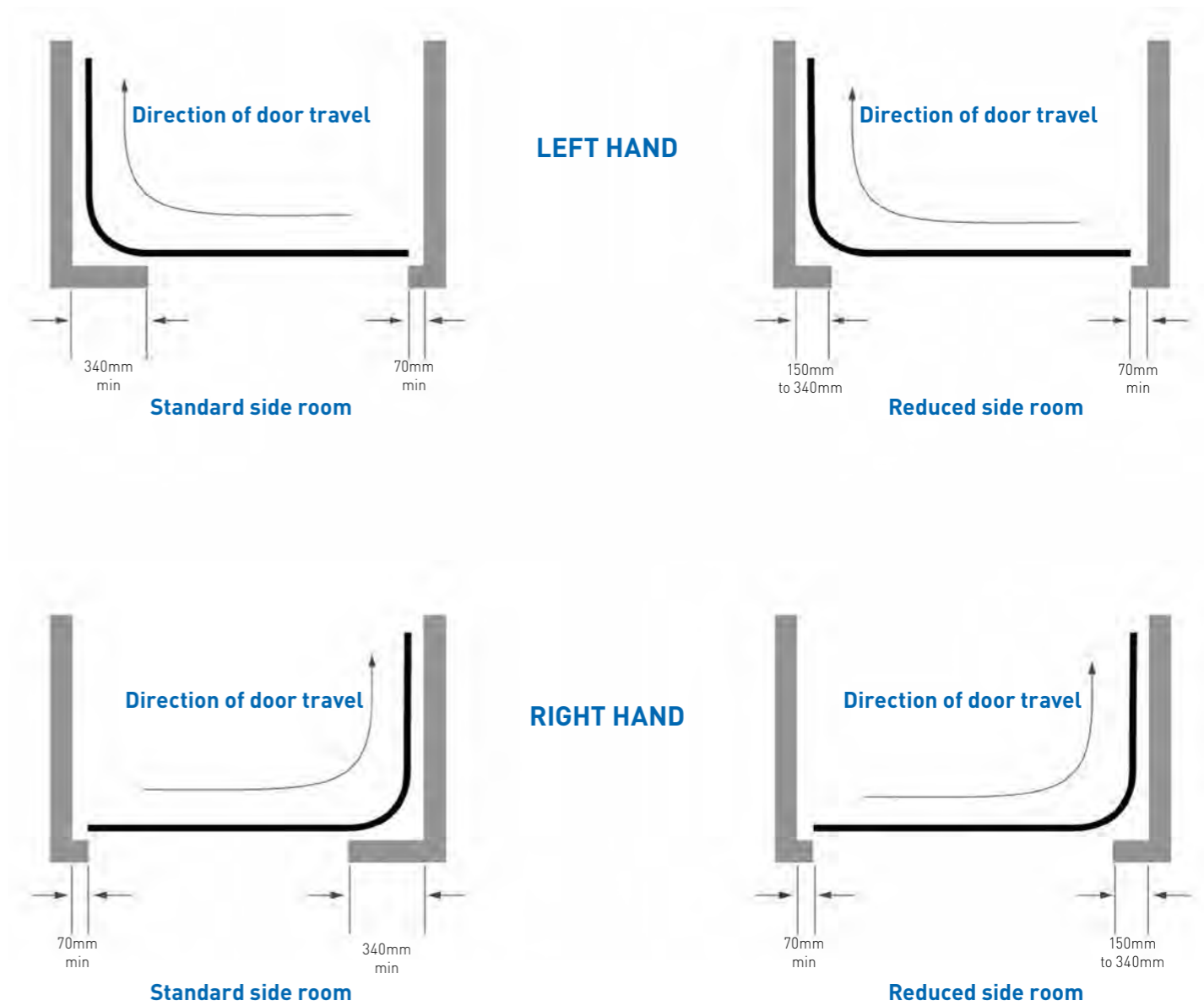

Specification

The door panel is made of self supporting steel construction, double-skinned with CFC free foam between two steel cover skins, fully galvanised with base paint.

Woodgrain texture on outer face of all panels, all styles (narrow rib, flush and panelled).

Panel thickness of 45mm, with heat insulation value of $K = 0.5 \text{ W/m}^2\text{K}$.

Galvanised header track with fastening anchor.

Header, floor and side seals are pre-assembled (continuous brush seal on 4 sides).

Side rebate - lock side must be at least 70mm.

Side rebate - curve side must be at least 340mm.

Headroom must be at least 100mm.

Side door handing options

(Please specify when ordering)

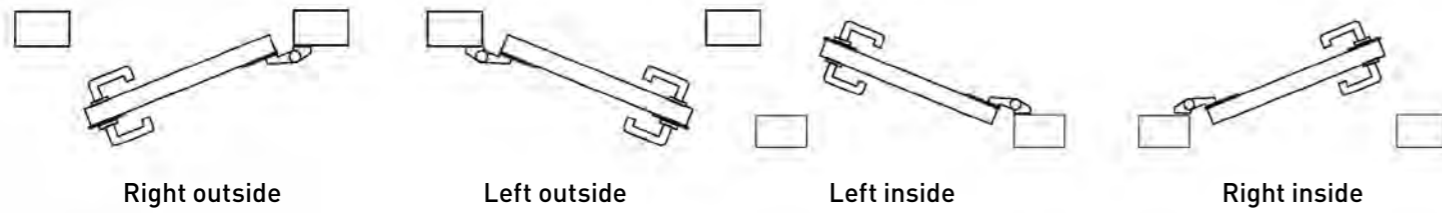

Up & over one piece matching side doors

(To match steel and timber infill doors)

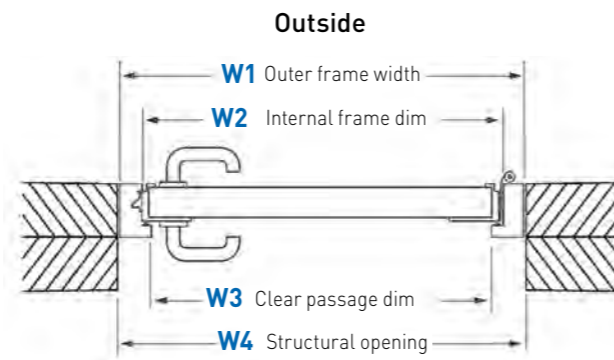
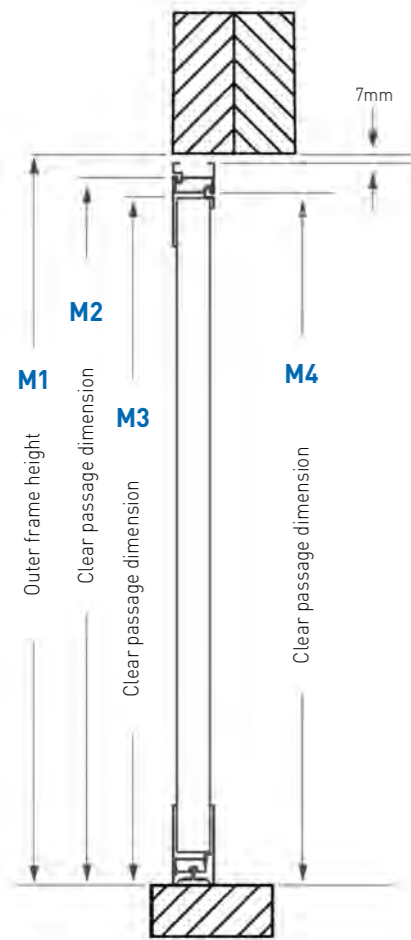

Order ref width	W1	W2	W3	W4
875	932	862	832	945
1000	1057	987	957	1070

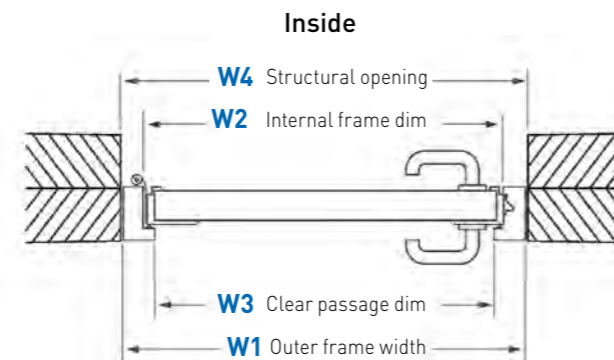

Order ref width	W1	W2	W3	W4
875	932	862	832	945
1000	1057	987	957	1070

ISO45 sectional matching side doors

(To match iso20 and iso45 steel sectional overhead doors)

Door opening inwards vertical section

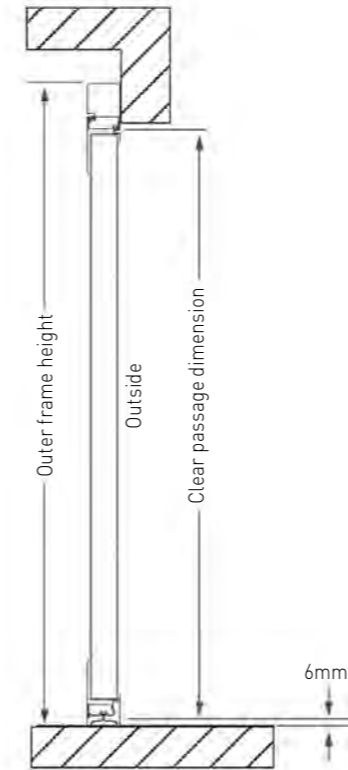

Door opening inwards and outwards vertical section

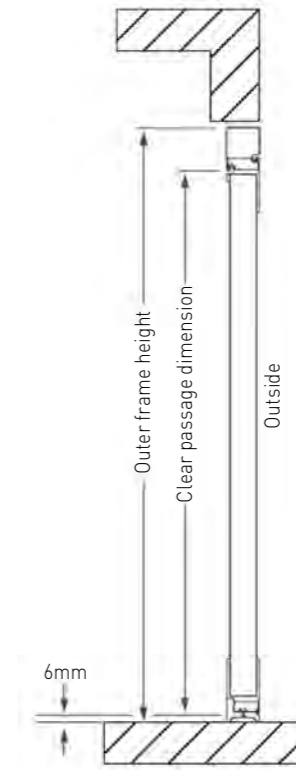

Door opening inwards - standard size horizontal section

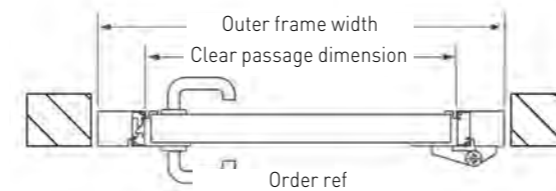

Door opening inwards and outwards - special size horizontal section

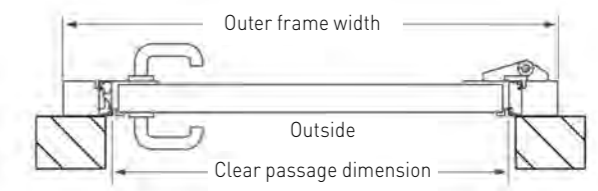

Standard sizes

horizontal rib, large rib, flush, raised panel

Door order ref	Order sizes outer frame dimensions	Clear passage dimensions
875 x 2000	995 x 2060	845 x 1970
875 x 2125	995 x 2185	845 x 2095
1000 x 2000	1120 x 2060	970 x 1970
1000 x 2125	1120 x 2185	970 x 2095

Fitting within the aperture

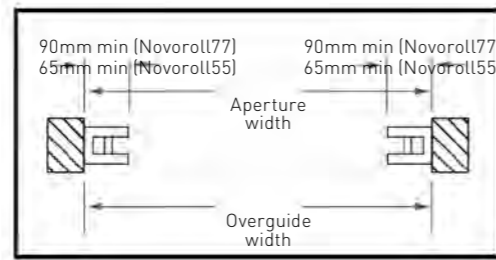
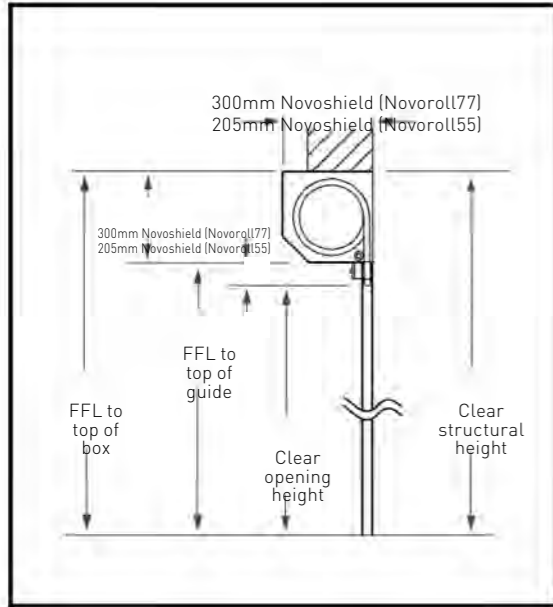

Fixing options

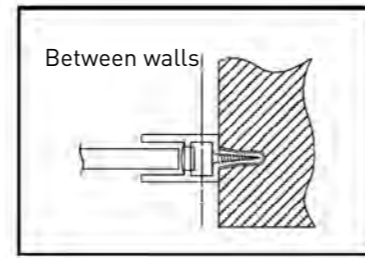
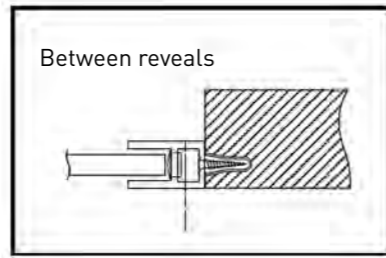

Fitting onto the aperture

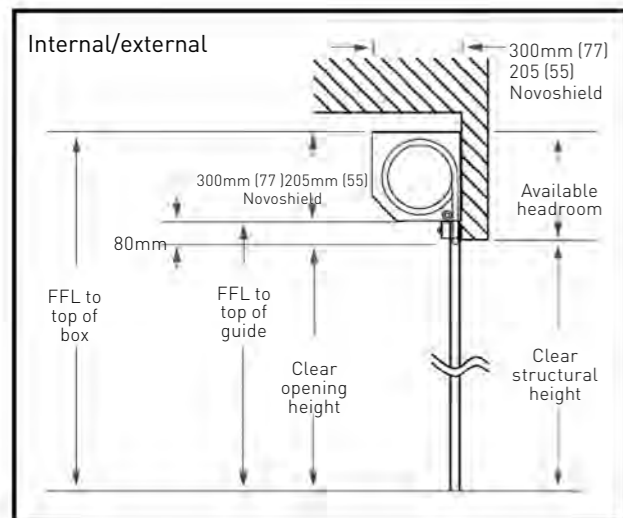

SIDE CLEARANCE: 90mm (65mm) is required only if the guides are to be fully concealed. A minimum of 40mm (30mm) is required to give sufficient room for fixing but a portion of the guide tracks (white as standard) will be visible.

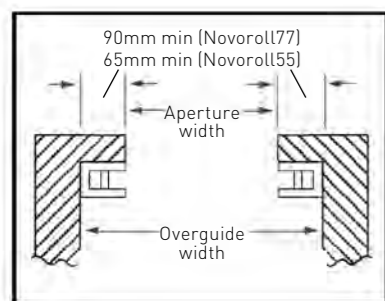

Fixing options

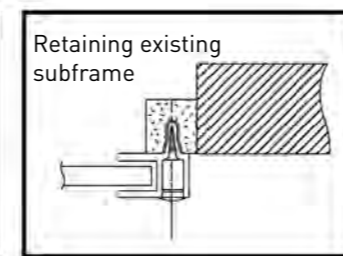
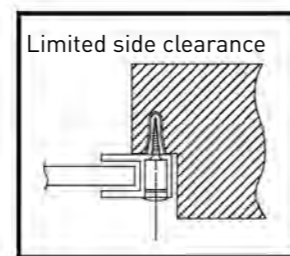
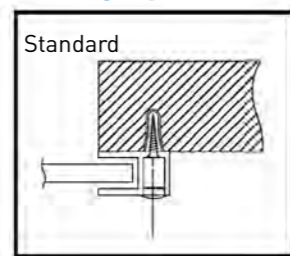

Warranty

In the unlikely event of a warranty claim becoming necessary please contact the dealer or distributor who supplied the door. To enable your claim to be processed without delay you should provide the following information:

- Your name, address and contact telephone number
- The original invoice and date of purchase
- A description of the door, the door type and the product number
- A description of the reason for the claim

Your dealer will then supply details of your claim, together with a copy of the warranty card supplied with the door and proof of purchase, to the warranty department at Novoferm UK.

An assessment of the claim will be made. This may mean Novoferm will need to come and inspect your door at your premises.

In the event that there is no legitimate claim under the terms of the warranty you may be liable for the costs of this visit.

It is essential that you take note of the care and usage instructions provided with your door and you follow these instructions throughout the lifetime of your door.

The warranty does not cover:

- Improper installation
- Normal wear and tear
- Priming and other surface protection treatments
- Negligent or wanton destruction
- Incorrect or too late applied surface protection treatments
- Repair by a non-qualified installer
- Use of non-Novoferm parts without the approval of Novoferm
- Damage or removal of the product number or making it unidentifiable
- Improper operation
- External influences, such as fire, salts, water, acids, alkaline solutions, abnormal environmental influences
- Mechanical damage caused by improper transport or installation

All dark colours which are exposed to direct sunlight should be avoided. Dark coloured doors may undergo expansion due to heat absorption. Such instances are not covered by the guarantee, however normal performance will revert when the door has cooled down if the heat absorption has affected the door's performance.

All previous price lists are rendered invalid with the publication of this price list. All products are sold subject to our standard conditions of sale, which are available on request and include the following:

Prices

All orders are accepted on the understanding that the goods will be subject to the prices ruling at the time of delivery, unless other terms are specifically agreed. All prices are in £ sterling and exclude VAT. UK mainland delivery is included to the buyers trading address - delivery to site £54.00 (subject to access).

A 25% handling charge applies to all unwanted items on standard **"*highlighted in bold"** stock items only. Items must be returned unopened and in an unused condition. All returns are subject to acceptance by Novoferm UK Limited.

All doors not highlighted are bespoke and made to order. The designs & sizes in this price list are an indication of price only and they are not stock items. Your right to cancel is not available on non-standard made to order doors.

Specification

Due to the progressive outlook of the Novoferm Group we reserve the right to alter specifications to design and manufacture without notification. All specifications and details are correct at the time of publication, errors and omissions excepted.

All Doors

Colour match Pairs of doors should be ordered together to obtain the best colour match, bearing in mind the limitations of the materials used in the construction. Timber garage doors cannot be ordered as matching sets.

Size variations As the size of a door changes in height and/or width, the panel frequency and profile can change, therefore doors of the same style but of different sizes can be significantly different in appearance.

Clearances All doors require operating clearances, i.e. the gap between the door panel and frame opening, these are inbuilt during manufacture and should not be reduced by means of infills, or draughtproofing.

Deflection When in the open position, all doors will display a level of vertical deflection or 'sag' across the width of the panel. Individual manufacturers' specifications should be consulted for exact tolerances.

Up & Over Garage Door Systems:

The purchaser is granted a warranty covering the safe and reliable operation of the Novoferm garage door for a period of **10 years** from the date of purchase. This warranty is conditional on the regular inspection and maintenance of the product in accordance with the installation manual supplied with the door. During the guarantee period the manufacturer undertakes to repair, without charge, any product which has suffered a proven failure of its safe and reliable operation provided that the springs, tracks and guide rollers have been inspected regularly (at least once a year) and maintained correctly, including replacement of wear items when required.

All Novoferm garage doors offer a 10 year warranty against the integrity of the door panel, as well as 2 years on rollers and springs for normal use, up to 25 open and close cycles a day.

All retractable garage doors offer a 10 year manufacturer's guarantee (2 years for canopy doors) on material and manufacturing faults of all immovable frame parts, if it can be proved that they are inoperative, or their use is impaired.

In the case of Novoferm steel doors, these are supplied factory prefinished in polyester based white. They are not immune to damage which can occur at any stage of the handling of the product from factory to site. Minor surface damage can be easily repaired using touch-up sprays or sticks without invalidating warranties. The corrosion of swarf filings or other air borne particles, rusting or staining of the panel is not considered as panel rust. Novoferm timber doors use organically grown Cedar from replenishable sources, with natural colour and grain variations - this is a feature of Cedar. We make every effort to harmonise the effect, where possible, by hand matching the component parts used in construction.

Please note that a uniform grain pattern cannot be guaranteed. Timber doors must be finished in accordance with the installation instructions, supplied with the door and the technical specification. Novoferm timber doors are supplied with a temporary finish. As soon as the door is unwrapped one coat of a good quality basecoat primer must be applied to both sides of the door. Immediately after installation your timber doors require two further coats of a good quality exterior wood finish on both sides. Initial application and periodic treatment should be carried out strictly in accordance with the woodstain manufacturer's instructions. Failure to follow these instructions will result in early deterioration of the timber panel. Please note that protective finishes on all Timber doors must be applied to validate warranty.

Sectional Garage Door Systems:

The purchaser is granted a warranty covering the safe and reliable operation of the Novoferm garage door for a period of **10 years** from the date of purchase. This warranty is conditional on the regular inspection and maintenance of the product, in accordance with the installation manual supplied with the door. During the guarantee period the manufacturer undertakes to repair, without charge, any product which has suffered a proven failure of its safe and reliable operation provided that the springs, wire cables, tracks, guide rollers and hinges have been inspected regularly (at least once a year) and maintained correctly, including replacement of wear items when required.

All Novoferm garage doors offer a 10 year warranty against the integrity of the door panels, as well as 2 years on rollers, springs, pulleys and cables for normal use, up to 25 open and close cycles a day.

All Novoferm garage doors offer a 10 year manufacturer's guarantee on floor seals, central seals, side seals and header seals against perishing. All Novoferm garage doors offer a 10 year manufacturer's guarantee on material and manufacturing faults of all immovable frame parts, if it can be proved that they are inoperative, or their use is impaired.

Furthermore, Novoferm fully finished steel doors (i.e. factory finish painted, Golden Oak, Rosewood) come with a 10 year panel corrosion guarantee relating to rust through inside or outside. If a panel rusts through, then the affected panel only will be replaced. Due to weathering, the new panel may not exactly match the colour of the old. In this instance the door should be repainted by the customer with a proprietary paint system, following the paint manufacturers' instructions.

All steel parts are not covered by the corrosion warranty if situated within 3 miles of the coastline.

In areas of high corrosion, (e.g. if exposed to sea air), the door panels should be painted with a proprietary paint system, following the paint manufacturers' instructions and that the door should be regularly cleaned. The corrosion of swarf filings or other air borne particles, rusting or staining of the panel is not considered as panel rust.

The surface finish of Rosewood and Golden Oak foil finished sectional door panels is guaranteed from serious degradation for a period of 5 years, provided that regular maintenance including cleaning from salt is carried out in accordance with our instructions.

During this period the colour of the door panels may change due to weathering (e.g. Intense UV radiation and coastal conditions etc). This is normal and is not covered by the warranty.

In the case of Novoferm pre-finished steel doors, these are supplied with polyester based primer paint finish. They are not immune to damage which can occur at any stage of the handling of the product, from factory to site. Minor surface damage can be easily repaired using touch-up sprays or sticks without invalidating warranties. Novoferm timber sectional doors are supplied unfinished, please ensure that a full specification of finishing coats are applied immediately before or after installation to all exposed surfaces - inside and out, with a Sikkens or similar finishing coat system. Please note that protective finishes on all Timber doors must be applied to validate warranty.

Novoferm Insulated Roller Garage Door Systems:

The purchaser is granted a warranty covering the safe and reliable operation of the garage door for a period of 10 years from the date of purchase. This warranty is conditional on the regular inspection and maintenance of the product, in accordance with the installation manual supplied with the door. During the guarantee period the manufacturer undertakes to repair, without charge, any product which has suffered a proven failure of its safe and reliable operation, provided that the door has been inspected regularly (at least once a year) and maintained correctly, including replacement of wear items when required.

Novoferm Insulated Roller Garage Door systems are guaranteed against any form of manufacturing defects for a period of 2 years from the date of purchase. The finish of white powder coated doors is guaranteed for a period of 2 years.

In the case of textured woodgrain finished doors, the exterior finish is guaranteed to provide an effective weatherproof membrane which will resist perforation of the door from the weather-side due to corrosion for 10 years. Furthermore, colour change or fade to the exterior surface will be limited and uniform for the full 10 year period.

Some marking may occur at the top of the internal side of the door curtain, this is unavoidable and is due to prolonged contact with autolock system.

Novoferm Garage Door Automation:

For garage door operators: Novoport® and Novomatic, we grant the following warranty, in case of supplying us with the original invoice: 5 years for mechanical parts of the operator motor and the control unit; 2 years for remote control parts and accessory parts.

A 2 year warranty is also granted for remote control parts and accessory parts. No warranty claims will be accepted for wear and tear parts and consumption parts (e.g. light bulbs, batteries, fuses).

Novoferm Insulated Roller Garage Door electric operators are guaranteed against any form of manufacturing defect for a period of 5 years for mechanical elements, motors and transformers. The motor control unit is guaranteed for 3 years. Remote control accessories and parts are guaranteed for a period of 2 years. No warranty claims will be accepted for wear and tear parts and consumable parts (e.g. light bulbs and batteries).

Door Maintenance

If in doubt about any maintenance procedures, please consult a Novoferm specialist. Novoferm has a nationwide network of installers who can offer you regular maintenance service on your garage door. Please call Novoferm on 01582 563777 or check our website for details of your nearest installer.

Immediately after the door is fitted and after every 5,000 operations of the door, or at least once a year, oil all pivot points and check tightness of screws and clamped connections. Keep running tracks clean (do not grease them), check all parts and replace any worn components.

The springs should be replaced by an experienced door fitter after approximately 25,000 operations (see fitting and operating instructions). You should not oil the lock cylinder. If it is sticking, lubricate it with graphite dust.

If you have a canopy door, check the cable every 6 months of normal usage (8 operations per day). If you find any wear, you should have the cables replaced by an expert fitter.



Novoferm UK Limited
Unit 5-9 Luton North Industrial Estate, Sedgwick Road, Luton LU4 9DT
t: 01582 563777 f:01582 568801
www.novoferm.co.uk e: info@novoferm.co.uk
Opening times: Mon-Fri 8.30am - 5.00pm



a member of the Sanwa Shutter family

In line with Novoferm's policy of continuous product improvement, we reserve the right to make changes without prior notification. Whilst every effort has been made to provide an accurate representation, colours shown in this brochure and supplied as physical samples are for illustrative purposes only and may vary from the product received. The contents of this brochure are ©2015 Novoferm UK Ltd.