

HDANYWHERE™

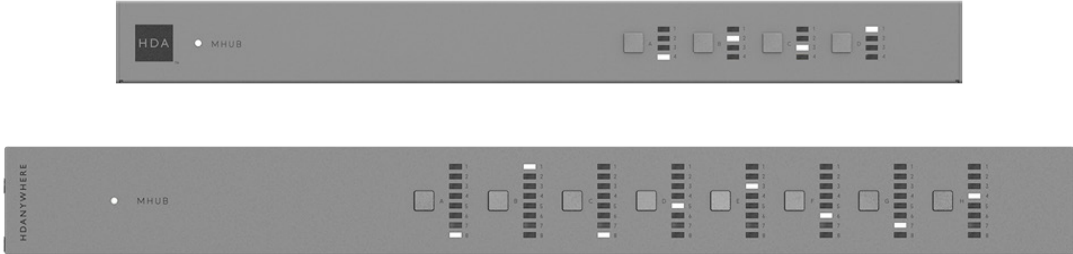

MHUB U

MHUB U (4x3+1) 40 CODE: MHUBU43140

MHUB U (8x6+2) 40 CODE: MHUBU86240

Box. Fe

1.

features. Specs.

Contents

Glossary of terms, In the box	4-5
Features, Specifications	6-7
Panel description & MHUB U (4x3+1) 40 panel diagram	10-11
MHUB U (8x6+2) 40 panel diagram	12
MHUB U display receiver & HDMI IR dongle description	13
IR (Infrared) control	14
Using the Master Remote Control, Testing that IR works	15
Cabling	16
Hiring a HDA Pro	17
MHUB control methods	18
Control drivers & API	19
Example wiring diagram & explanation	22-23
Power up	24
Setup on uControl	28-29
Accessing MHUB-OS & settings	32-33
uControl interface	36-37
Legals: Compliance, conformity, Product Guarantee	40-41

Glossary of terms

Control System	A 3rd party method of control for MHUB systems. For example, Crestron, Control4, RTI, Savant, Fibaro etc.
HDBaseT	Technology used to convert HDMI in to a format which can be carried over network cable.
IR RX & IR TX	Infrared (IR) Receiver (RX) and Transmitter (TX). The RX 'receives' a signal from another remote control and the TX 'transmits' it.
MHUB	Video or Audio distribution systems manufactured by HDANYWHERE.
MHUB-OS	MHUB's on-board operating system from which most settings can be configured.
Tipping Point Compression (TPC)	Video content such as Ultra HD 4K 60 4:4:4 uses up to 18Gbps of data at any one time which is not possible over current HDBaseT technology. HDA makes transmission of 18Gbps content possible using TPC. Visually lossless, TPC only becomes active if HDBaseT's threshold is breached, hence the term tipping point.
uControl	A remote control app made by HDANYWHERE and available from iOS & Android app stores.



In the box



Name: **MHUB U (4x3+1) 40**
 Product code: **MHUBU43140**

- x1** MHUB U (4x3+1) 40 Chassis/Hub
- x3** Display receiver
- x1** HDMI IR Dongle
- x8** Infrared Transmitter cable (1.5m) (IR TX)
- x5** Infrared (20-60Khz) Receiver cable (1.5m) (IR RX)
- x4** Three Pin Phoenix Connector
- x1** Serial to Three Pin Phoenix cable
- x4** Chassis rubber feet
- x1** Chassis wall mounting kit inc. screws
- x3** Display receiver mounting brackets inc. screws
- x1** Master remote control
- x1** 24V 2.7A Power Supply with IEC lead
- x1** User Guide

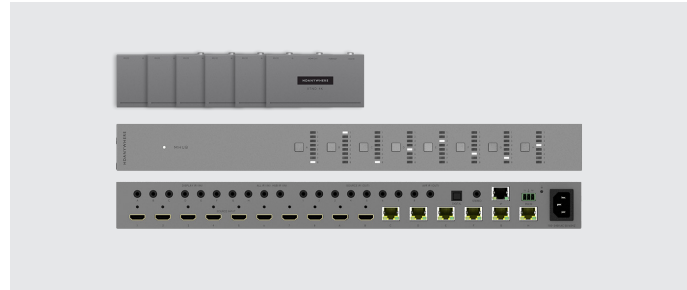

Name: **MHUB U (8x6+2) 40**
 Product code: **MHUBU86240**

- x1** MHUB U (8x6+2) 40 Chassis/Hub
- x6** Display receiver
- x2** HDMI IR Dongle
- x15** Infrared Transmitter cable (1.5m) (IR TX)
- x9** Infrared (20-60Khz) Receiver cable (1.5m) (IR RX)
- x7** Three Pin Phoenix Connector
- x1** Serial to Three Pin Phoenix cable
- x4** Chassis rubber feet
- x1** Chassis rack mounting kit inc. screws
- x6** Display receiver mounting brackets inc. screws
- x1** Master remote control
- x1** IEC Power lead
- x1** User Guide

IMPORTANT:

For optimum performance and safety, please read these instructions carefully before connecting, operating or configuring this product. Please keep this manual for future reference.

Surge protection is recommended

This MHUB system contains sensitive electrical components that may be damaged by electrical spikes, surges, electric shock, lightning strikes, etc. The usage of surge protection systems is recommended in order to protect and extend the life of your system.

Features

Supports video picture formats up to 4K@60Hz (4:4:4)

Multi-channel digital audio support up to and including Dolby/Atmos and DTS:X

Simultaneous multi-channel and stereo audio (no downmix)

Bi-directional IR (Display Receiver)

EDID management

uControl & Amazon Alexa compatible

Remotely monitorable

Includes HDA API 2.1

AVR IR control port

Power over HDBaseT (PoH)



Specification

HDMI version	HDMI 2.0b
HDCP compliance	HDCP 2.2 & HDCP 1.4
Video bandwidth	18Gbps
Video resolution	Up to 4K@60Hz (4:4:4) with HDR
Colour space	RGB, YCbCr 4:4:4, YUV 4:4:4, YCbCr 4:2:2/4:2:0
Colour depth	8-bit, 10-bit, 12-bit
HDR formats	HDR10, HDR10+, Dolby Vision, HLG
Video & audio IO	MHUBU43140 Inputs: x4 HDMI Outputs: x3 HDBaseT, x1 HDMI, x1 3.5mm Stereo Jack, x1 Optical MHUBU86240 Inputs: x8 HDMI Outputs: x6 HDBaseT, x2 HDMI, x1 3.5mm Stereo Jack, x1 Optical
Transmission distance	1080p 70m 4K 40m
HDMI audio formats	PCM 2.0 / 5.1 / 7.1, Dolby Atmos / Digital / Plus / EX, Dolby True HD, DTS, DTS-EX, DTS-96 / 24, DTS High Res, DTS-HD Master Audio, DSD, DTS:X
Optical audio formats	PCM 2.0, Dolby Digital, DTS
Stereo audio formats	PCM 2.0
Infrared	20Khz - 60Khz
ESD protection	±8kV (Air-gap discharge) ±4kV (Contact discharge)

Power consumption	MHUBU43140: 35W (Maximum) 1W (Standby) MHUBU86240: 74W (Maximum) 1W (Standby)
Power supply	MHUBU43140 Chassis: 24V 2.71A MHUBU86240 Chassis: 100-240V AC 50/60Hz Display Receiver: 24V PoH (Power over HDBaseT)
Operating temperature	0°C - 40°C / 32°F - 104°F
Storage temperature	-20°C - 60°C / -4°F - 140°F
Relative humidity	20 - 90% (Non-condensing)
Housing	Chassis: Aluminium Display Receiver: Aluminium
Colour	Grey (Carbonite)
Dimensions (W/D/H) mm	MHUBU43140 Chassis: 372 x 167 x 36 MHUBU86240 Chassis: 440 x 284 x 45 Display Receiver: 140 x 65 x 18
Weight (g)	MHUBU43140 Chassis: 1900 MHUBU86240 Chassis: 2400 Display Receiver: 125

10. Control

2.

rol. IR. Cabling.

Panel descriptions

Rear Panel

1. **Source (IN):** HDMI video input ports indicated by numbers.

2. **Video (OUT):** HDBaseT (RJ45) & HDMI video output ports. 18Gbps video will pass through HDMI ports (uncompressed) whilst the HDBaseT port will use TPC (compression). The HDBaseT port has two indicator lights. Left light: solid means connection between MHUB and display receiver is good. Flashing means that the connection is poor. Off means that there is no connection detected. Right light: solid means HDCP is detected. Flashing means there is no HDCP. Off means no HDMI signal is detected.

MHUBU43140

Output A is HDMI. Outputs B-D are HDBaseT.

MHUBU86240

Output A & B are HDMI. Outputs C-H are HDBaseT.

3. **Source IR (OUT):** Connect an IR TX to control corresponding HDMI inputs.

4. **All IR (IN):** Connect an IR RX to this port to send a remote (IR) control command to all display receiver "IR (OUT)" ports.

5. **AVR IR (OUT):** Connect an IR TX to enable remote (IR) control of an AVR. These ports are accessible to uControl, control systems and MHUB's IR pass back system.

6. **Hub IR (IN):** Connect an IR RX to enable remote (IR) control of MHUB.

7. **Display IR (IN):** Connect an IR RX to enable remote (IR) control of corresponding displays connected to the Display Receiver.

8. **Control / IP:** Enables TCP/IP control of MHUB over Ethernet.

9. **RS232:** Enables a PC or control system to control MHUB over serial. Pinout (from left-to-right) is as follows: TX/GND/RX.

10. **GND:** Earthing point to connect MHUB case to ground (MHUBU86240 only).

11. **Digital/Stereo (OUT):** Optical & 3.5mm Stereo Jack audio output mirrored ports. Coax outputs multi-channel audio and the 3.5mm Stereo Jack outputs 2ch PCM with no downmix. This port is assignable to a video output which can be done from MHUB-OS.

12. **Power:** Connect the power supply to MHUB.

Front Panel

A. **Power:** LED indicator light. If this light is on and solid then MHUB has power and is on.

B. **Source Selector:** Selects a HDMI video input for outputs (A-D / MHUBU43140) or (A-H / MHUBU86240) depending on MHUB model.

Reset to DHCP:

Press and hold Source Selector button marked "A" for 10 seconds to restore MHUB back to a default network configuration (DHCP). Please note: you can not undo this action.



MHUB U (4x3+1) 40: front & rear panel

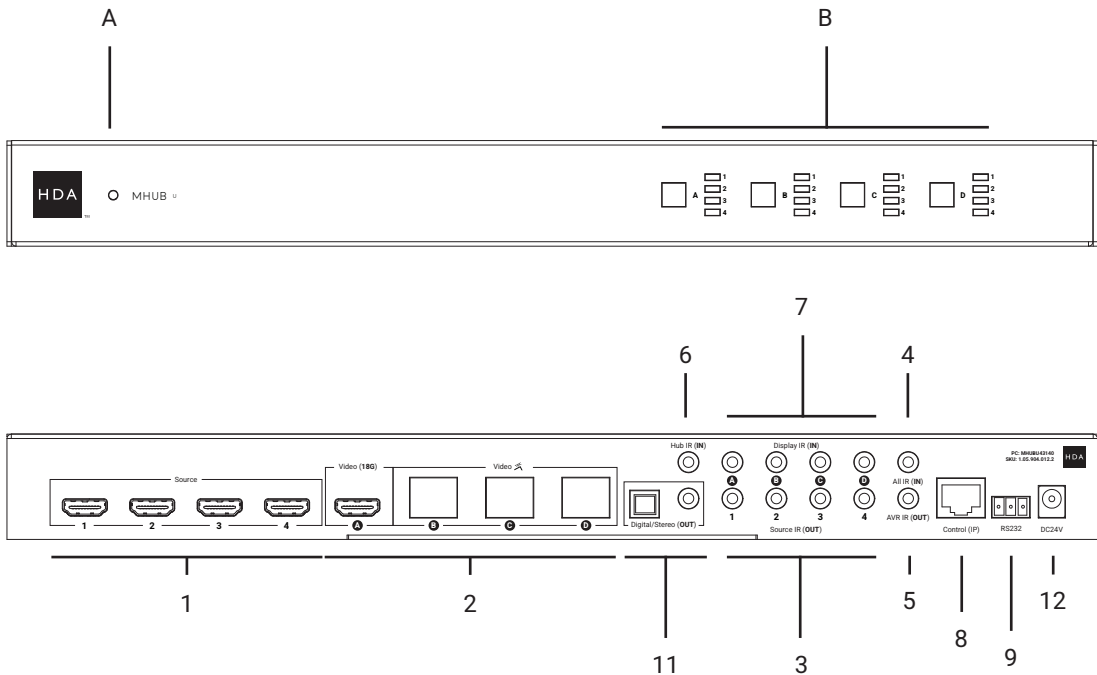

MHUB U (8x6+2) 40: front & rear panel

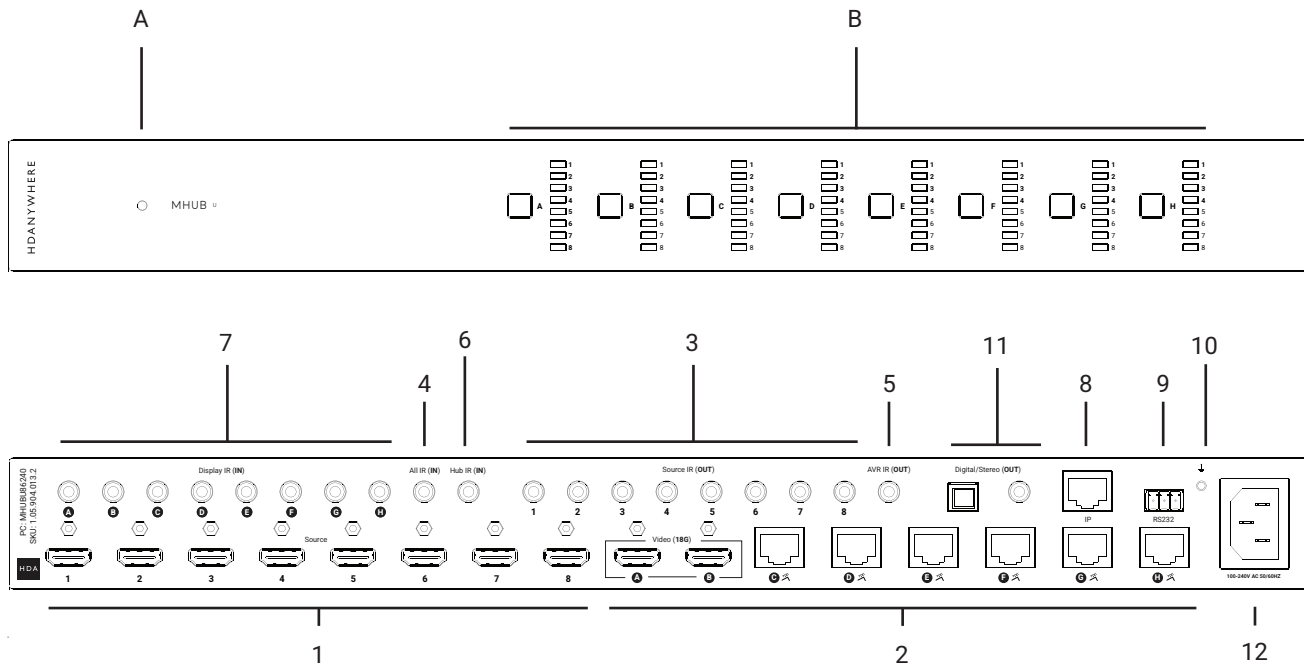

Display Receiver

1. **Power LED:** Indicator light. If this light is on and solid then the display receiver has power.
2. **Power:** DC24V / 1A. Unsupported port from other MHUB U systems.
3. **Video:** HDBaseT link between MHUB and display receiver. This port has two indicator lights. Left light: solid means connection between MHUB and display receiver is good. Flashing means that the connection is poor. Off means that there is no connection detected. Right light: solid means HDCP is detected. Flashing means there is no HDCP. Off means there is no HDMI signal at all.
4. **HDMI (OUT):** Connect a HDMI cable from the display receiver to your display to provide a picture.
5. **IR IN:** Connect an IR RX to send a remote (IR) control command from the display receiver to MHUB's active "Source / IR" port.
6. **IR OUT:** Connect an IR TX to this port to control displays using remote (IR) control commands.
7. **RS232 (OUT):** Unsupported port from other MHUB U systems.

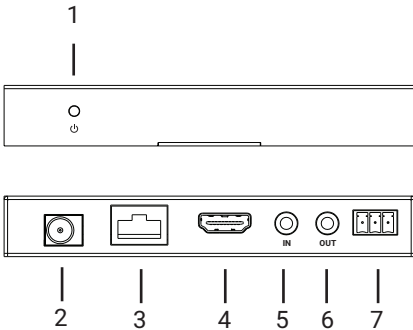

HDMI IR Dongle

MHUB supports the passing of IR commands over its HDMI output using the HDMI IR Dongle. If the Dongle is in "IR" mode then IR commands are able to pass from the display back to the MHUB.

1. **CEC/IR :** HDMI IR Dongle operating mode. Ensure that this switch matches the type of control method you wish to use.
2. **IR RX:** Connect an IR RX or TX (you can set mode in MHUB-OS) to this port to control displays or pass remote (IR) control commands back to your source devices.
3. **IN:** Connect a HDMI cable from MHUB.
4. **OUT:** Connect directly in to your display to provide a picture.

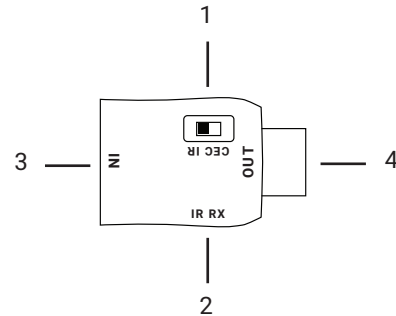

IR (Infrared) control

MHUB can manage IR signals and route them to sources, AVRs or displays. Using this feature will allow you to use a remote control and pass that IR command from your display location to MHUB or vice-versa.

Sending IR commands from a display 'back' to MHUB

This will enable backwards IR control (the most common form of IR control) where IR signals from a remote in any one of your zones is sent back to MHUB and your source device.

1. Connect an IR TX to port labelled "Source IR (OUT)" on MHUB. Ensure that the port number matches the port number of the corresponding video source input, labelled "Source (IN)". For example, if you have AppleTV plugged in to port 3, then the IR TX cable should also be connected to Source IR (OUT) port 3.
2. Place the IR TX bud (small tear drop part) in front of the IR window of the source. Repeat for each source device you wish to control.
3. Connect an IR RX to port labelled "IR IN" on the display receiver.
4. Place IR RX head in line-of-sight of the remote control.

Sending IR commands to a display

1. Connect an IR TX to port labelled "IR OUT" on the display receiver.
2. Place the IR TX bud (small tear drop part) in front of the IR window of the display. Repeat for each display you wish to control.
3. Connect an IR RX to port labelled "All IR (IN)" on MHUB.
4. Place IR RX head in line-of-sight of the remote control.

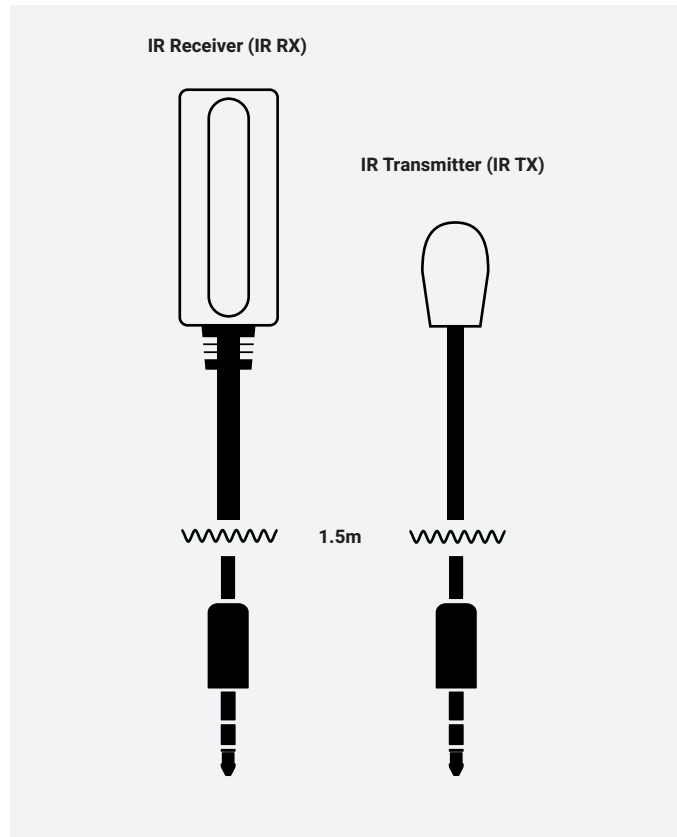

Using the Master remote

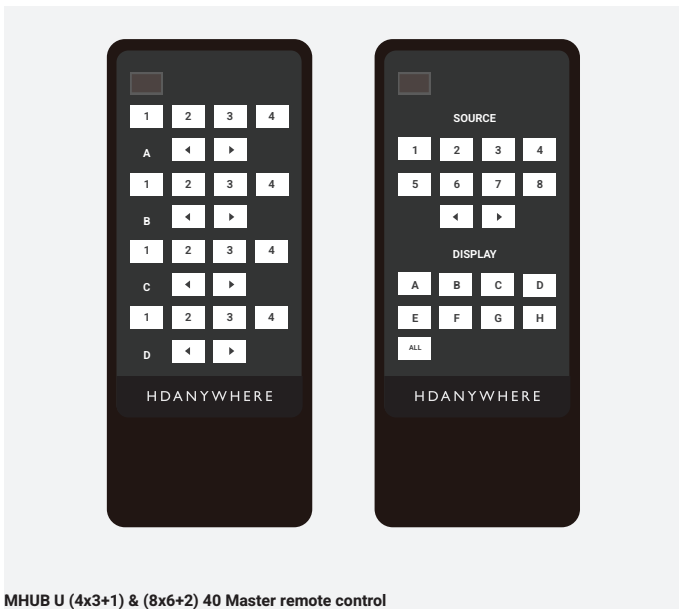

MHUB U (4x3+1) & (8x6+2) 40 Master remote control

MHUB comes with a master remote control.

The remote control is limited to video switching operations only (see section: "MHUB control methods").

The Master Remote control provides video switching control regardless of the room or zone that the command comes from. This is useful if MHUB is installed in an environment like a bar where you might want to switch all displays from one source to another.

Testing that IR control works

This section aims to verify that your MHUB's IR control system is setup correctly and assumes that your MHUB has been wired as per the instructions laid out in this manual. Please refer to the MHUB wiring diagrams in this document to ensure that your setup matches that before proceeding with the verification below.

Testing basic operation from a display 'back' to MHUB

To verify that IR control is working correctly proceed to any display receiver location with an IR RX connected to it. Use the MHUB Room Remote to select a source with an IR TX connected to it at the MHUB end. You should notice that the MHUB switches to that source on your display. Now pick up your source remote control for the source you just switched to and attempt to control the source using the native remote control. If both work then you have setup IR control correctly. Repeat this step for all display receiver locations.

Testing commands from MHUB to a display

To verify that control commands from MHUB to your display are working you will need to use uControl, or test using the following method. 1) select a display that you wish to test 2) connect an IR RX to the All IR (IN) port 3) ensure that the display receiver has an IR TX connected and that it is pointed to the display IR receiving window 4) take the display remote control to the MHUB location and point the remote at the IR RX, test the on/off command. The display should turn on or off. This will confirm that IR can pass from MHUB to your display successfully.

Working with identical source devices (discrete IR)

MHUB can work with multiple source devices that are identical due to its discrete IR function. Discrete IR avoids IR clashes that result in unwanted operation of all identical devices. MHUB manages this by targeting IR commands specifically to the source device being watched on the display. When using two or more identical source devices, take measures to avoid IR transmission leaks that could cause the identical source devices to respond in error. This includes simple measures like placing identical sources on different shelves or attempting to 'hood' the IR TX so that IR signals can not leak.

Cabling

Currently you can use Cat6, Cat6e, Cat6a, Cat7 or Cat7a with MHUB. Cat5e may work, but is not recommended, due to bandwidth requirements of the system.

Note:

DO NOT USE COPPER CLAD ALUMINIUM/STEEL (CCA/CCS) CAT CABLE.

Optimum performance

Whichever network cable type you choose, ensure that the main wiring architecture is 'solid core' and not stranded 'patch' cabling. Patch cabling can be used for the last few metres of a run (e.g wallplate) but should be avoided over longer runs as signal transfer over stranded cores is significantly impacted. The use of pre-made leads is not recommended unless you can be absolutely sure of their construction credentials (i.e. solid core 568B). For optimum performance, use a single piece of Cat cable terminated directly at the transmitter and the receiver ends. Make sure to use the correct connector types (i.e. RJ45 solid core) crimp connectors.

Shielded cables

Shielded FTP cable is not a stipulation. However, if you are using this type of cable ensure compatible shielded accessories are used. Failure to terminate cable screen at all points can induce interference rather than eliminate it.

Patch panels and wall plates

If patch panels are terminated correctly then there is a minimal loss of distance. The use of wallplates and patch panels has the potential to cause increased resistance on the cable introducing pinch points for signal transmission and could reduce transmission lengths. TIP: Instead of using RJ45 wallplates search for "brush plates" this will yield many results.

HDMI cabling

HDANYWHERE recommends using our own 18G Premium High Speed Slimwire Max or 48G Ultra High Speed Slimwire Max HDMI cables from your nearest stockist. It is not advised to use passive HDMI cables over 5 metres in length either on the inputs or the outputs of MHUB or its display receivers. Find our range of HDMI cables on <https://hdanywhere.com>.

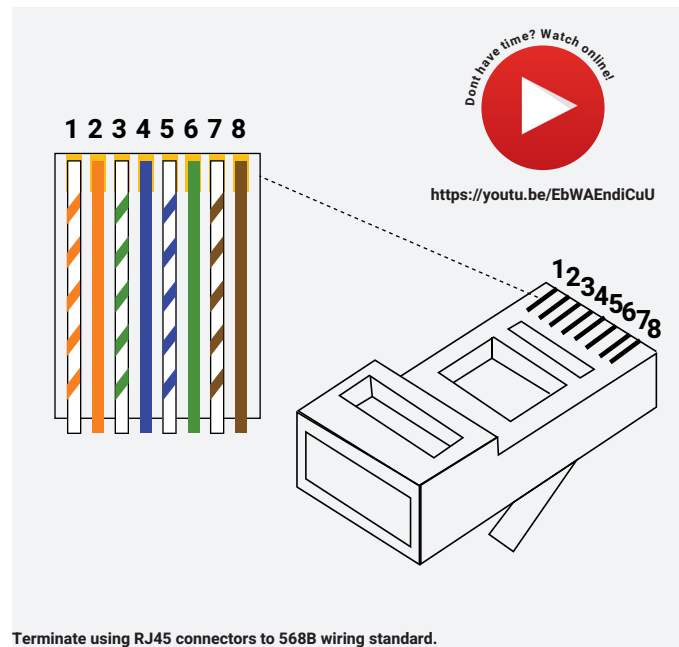

Terminate using RJ45 connectors to 568B wiring standard.



Hire a HDA Pro

If cabling infrastructure, installation and control seem like too much to absorb and learn then why not hire a HDA Pro to do the work instead for you?

Having your MHUB system professionally installed should help to guarantee the system's long-term performance and ensure that it blends neatly with your decor.

All HDA Pros have the added ability to manage your system remotely for you - meaning that routine maintenance and even advanced troubleshooting can be done without the need to visit your home. Ask our HDA Pros for home control, cinema, heating/AC, lighting and security services. Download a guide to picking a HDA Pro here: https://content2.hdanywhere.com/en/downloads/documents/hdanywhere_doc-picking-an-installer.pdf

Find a HDA Pro anywhere in the world today

Visit: <https://hdanywhere.com/dealers-and-installers/>



MHUB control methods

MHUB has been designed to be operated and controlled in numerous ways depending on your requirements. There are limited control options from the front panel and from the Master remote, so attention needs to be paid to the method by which MHUB will be controlled. The methods to control and considerations for each are listed below.

Remote Controls (IR)

MHUB supports the passing of IR commands from any display location back to MHUB and vice versa, this is described on pages 14-15. This is the recommended method to gain instant control of all source devices located near MHUB. Note: switching to audio sources such as ARC is not supported. In scenarios such as this, HDANYWHERE recommends using MHUB-OS' dashboard or uControl.

uControl

Available for free on iOS and Android, uControl is MHUB's native method of control. All of MHUB's built-in features are available; offering comprehensive control over switching, source/display control, ARC access and executing Sequences in all zones. uControl communicates over the same Local Area Network (LAN) as your MHUB which allows for global control over the entire system regardless of what zone you are in. In the absence of a third-party control system, HDANYWHERE recommends uControl as the method to control your MHUB on a daily basis.

Voice

All MHUB systems support voice control as standard via an Amazon Echo (Alexa) device. Voice control is not designed to act as a primary control method but to assist the other methods listed on this page. Using voice it is possible to change channels, execute sequences, turn MHUB on/off and basic transport commands such as play/pause/forwards/backwards from any zone. Please note that Amazon Alexa is not available in all countries.

Third-party control system

Control via a third-party control system is supported using our latest and most advanced API to date. For an up-to-date list of systems that MHUB supports please visit the "Control Drivers" section of our support site: <http://support.hdanywhere.com>. Control varies depending on the control system being used but typically, switching is supported with other drivers able to offer more. Please consult a HDA Pro (page 17) to find out more.

MHUB-OS

Any device with a web browser can control MHUB directly from MHUB-OS' dashboard. From here it is possible to control switching. MHUB-OS is also where all configuration for MHUB is done.



Help is only an email away: support@hdanywhere.com.

Control system drivers & HDA API

MHUB works with many control system providers. Find the latest drivers to download from <http://support.hdanywhere.com>.

Building your own control solution

Use MHUB's open API to create a customisable control solution. Replicate almost any function within MHUB in to your own control application.

Download the API here: https://cloud.hdanywhere.com/docs/api/hda_api.pdf

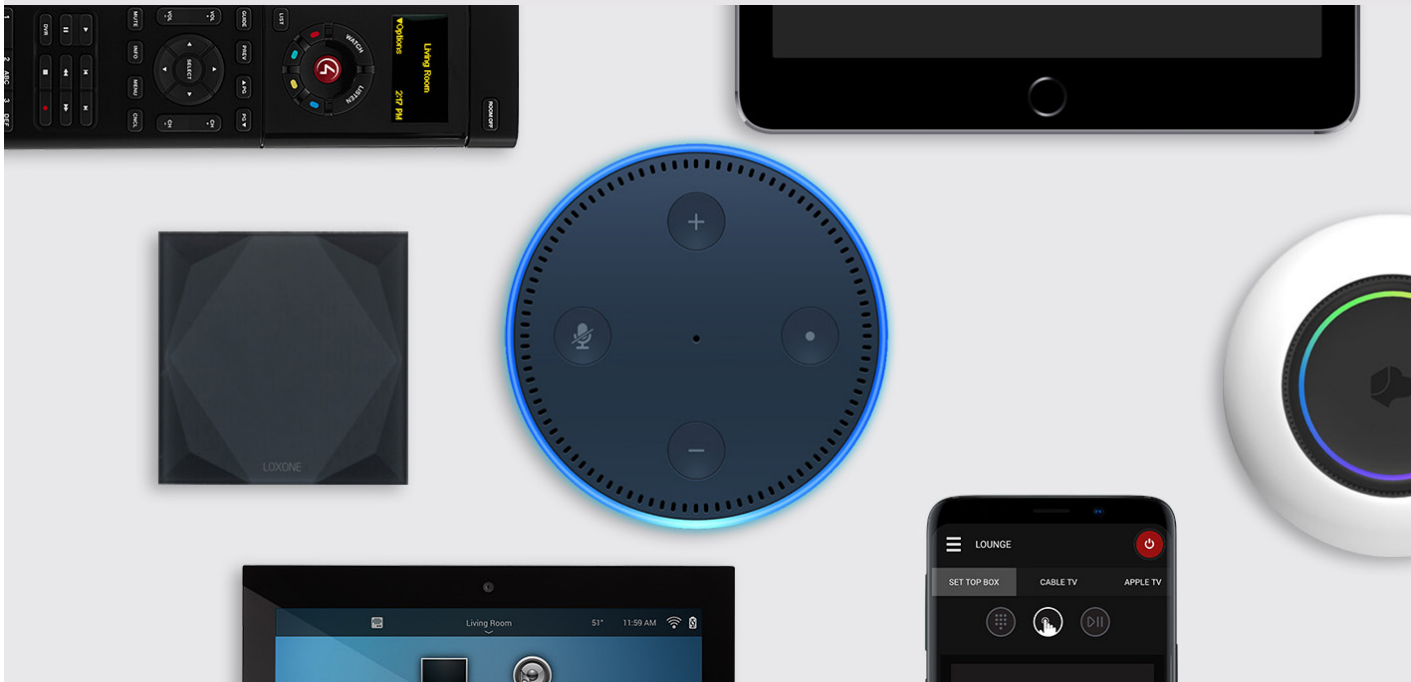

Wiring. Power

3.

Up. First Boot.

Example wiring diagram MHUB U (8x6+2) 40

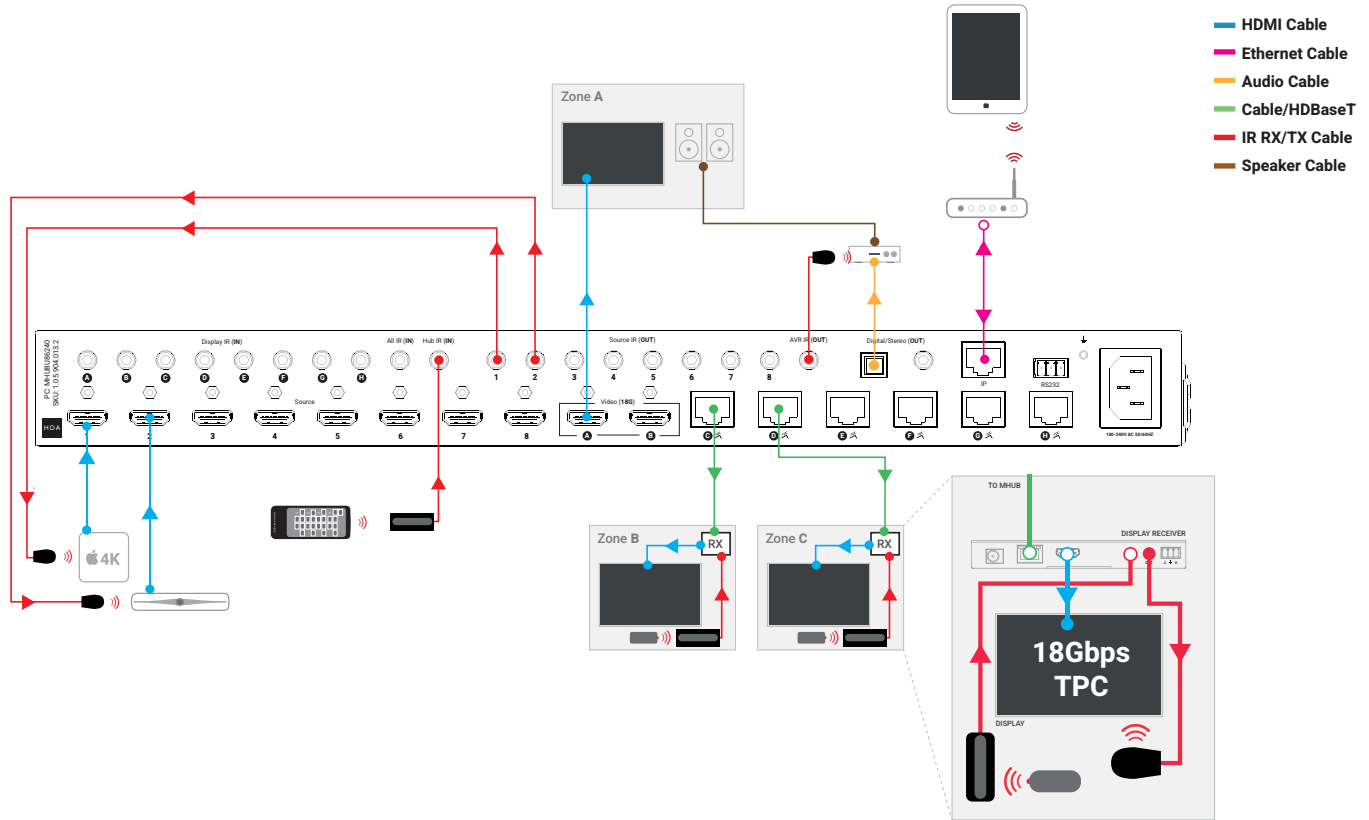

Extending a HDMI output and including IR

It is possible to extend the HDMI output of MHUB by pairing it with any XTND 4K model and following the guide below. Whilst it is not necessary to purchase the MHUB + XTND IR Integration Kit (SKU: 2.50.792 / labelled "1") it will make installation easier and less error prone. For integration examples please visit: <http://support.hdanywhere.com/2017/03/integrating-an-mhub-4k-4x318x62-with-an-xtnd-product/>. Illustration is MHUB U (8x6+2) 40.

- HDMI Cable
- Ethernet Cable
- 3.5mm Stereo
- CableHDBaseT
- IR RX/TX Cable
- Speaker Cable

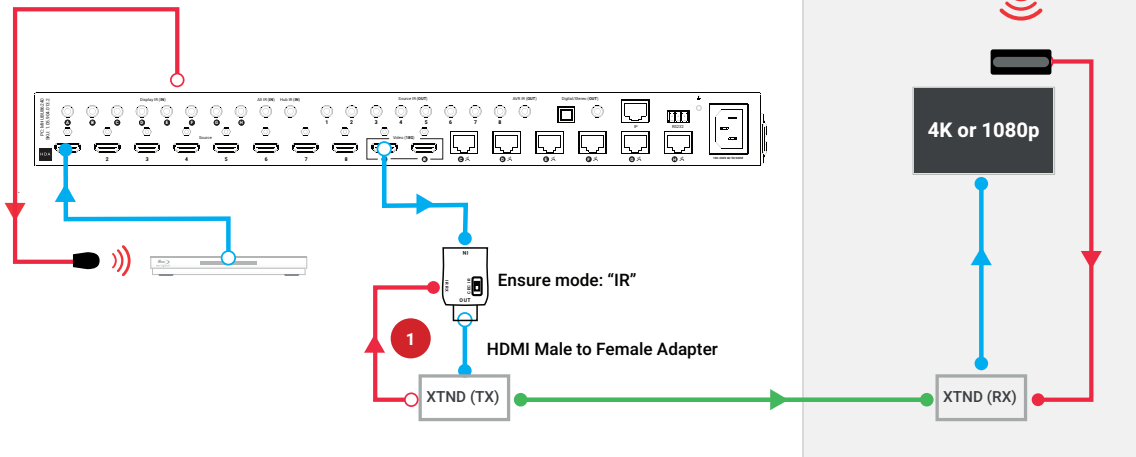

Power up

This section describes the power up process for MHUB U, operating in standalone mode (by itself).

Power up sequence for MHUB U

- 1 Ensure that all devices are turned off.
- 2 Connect HDMI sources to the input ports on MHUB. If any sources require IR control, ensure that IR is connected at this stage as well.
- 3 Connect the display receiver to MHUB using Cat 6/7 cable in to MHUB's video output port.
- 4 Connect any HDMI video outputs such as displays, AVRs or mirrored displays using HDMI cables from MHUB's video output ports.
- 5 Connect MHUB's audio output ports to speakers, AMP/AVRs or distribution hardware such as MHUB AUDIO.
- 6 Ensure that HDMI cables are fed from display receivers or HDMI IR Dongles in to their respective displays and that any IR hardware is connected as well.
- 7 If you are connecting to LAN via Ethernet then connect a cable between your router and the IP control port on your MHUB.
- 8 Plug in the supplied power lead, MHUB will automatically power on and power will be fed to all display receivers. MHUB and any connected display receivers LED indicators should be lit and solid.
- 9 Turn on each source device one after another followed by each display.
- 10 Ensure that displays are set to the correct HDMI input. Picture and sound from source devices will now be displayed on screen.
- 11 MHUB will start its power up sequence (this can take up to 120 seconds after step #8). Ensure this period has passed before proceeding to the next step.
- 12 Install uControl on your iOS or Android device and run the application.
- 13 Complete setup on uControl (see "Setup on uControl").



Notes

Setup w

4.

with uControl.

Setup on uControl

Before starting setup on uControl, ensure that your MHUB is wired correctly and has been on for over 120 seconds to ensure that it is fully initialised. If you are connecting to MHUB via Ethernet cable then make sure your phone or tablet is also connected to the same network and proceed with setup detailed below.

uControl is required for setup but optional to use

uControl is available on iOS and Android Play stores and can be found by searching “uControl” - look for a black icon with “HDA” written inside it. You do not need to use uControl with your MHUB but it is required to setup your MHUB system.

Start setup with uControl (Part 1)

1. Load uControl. You will be presented with an intro screen which will automatically disappear or can be swiped away.
2. You will be at the home screen. If your MHUB is connected to your network via Ethernet cable then select “Connect to MHUB System”.
3. uControl will scan for devices in your network over Ethernet or Wifi.
4. If there are no errors in the scan then uControl will present you with the following options:
 - A. If a standalone MHUB is found then uControl will proceed to configure that system directly. Jump to step #7.
 - B. If multiple MHUB's are found then uControl will ask if you want to stack those systems (if supported) or connect to one of them individually.
5. If MHUB is being setup in Stack mode then you will be asked to nominate a Master and Slave device(s).
6. uControl will then connect to your system to start the configuration process.
7. You will now be redirected to MHUB-OS, the operating system on board MHUB, to complete the first boot process (see next page).



... From uControl, proceed to configure MHUB-OS' first boot process (Part 2)

1. EULA & Privacy Policy

End User License Agreements and Privacy Policy statements. You can not proceed with setup if these are not agreed to first.

2. Name your MHUB

Provide a unique name for your MHUB so that you can identify it easily.

3. Name your source devices

Give each one of your source devices a unique name (eg "Sonos", "CD Player") so that you can identify and switch to easily.

4. Create zones

A zone is a room or location in your property where outputs from MHUB terminate in (eg "Kitchen", "Living Room", "Bar").

5. Assign outputs to zones

A zone can contain up to 1 output in total.

6. Confirm zones

An opportunity to review your changes.

7. Connect MHUB to HDA Cloud

Register MHUB on HDA Cloud to access online services, to extend your warranty and to grant permission for remote monitoring and management to take place if your MHUB has been installed by a HDA Pro. The email address must belong to the owner of the MHUB device.

8. Complete setup

A final step before returning back to the main uControl interface.

6.

MHUB-OS.

Accessing MHUB-OS

MHUB-OS is the operating system on board all MHUB systems and must be configured first before you can use it (see page 28-29). MHUB-OS manages the operation of your MHUB, the connection between MHUB and your control method (see page 18) and the connection to online services like HDA Cloud and Amazon Alexa. MHUB-OS is not typically a feature that you would access daily but something where configuration and user settings are applied so that MHUB operates in the manner you like.

Accessing MHUB-OS

1. Ensure that you have completed the first boot process and that MHUB is on and connected to your network.
2. Load uControl: it will connect with MHUB and you will be taken to the main control interface.
3. Tap on the Menu icon represented by three horizontal lines. A menu will appear from the left side of your screen.
4. Tap on the Cog icon in the bottom left corner to be navigated to the main Settings menu.
5. Select option: "Access MHUB".

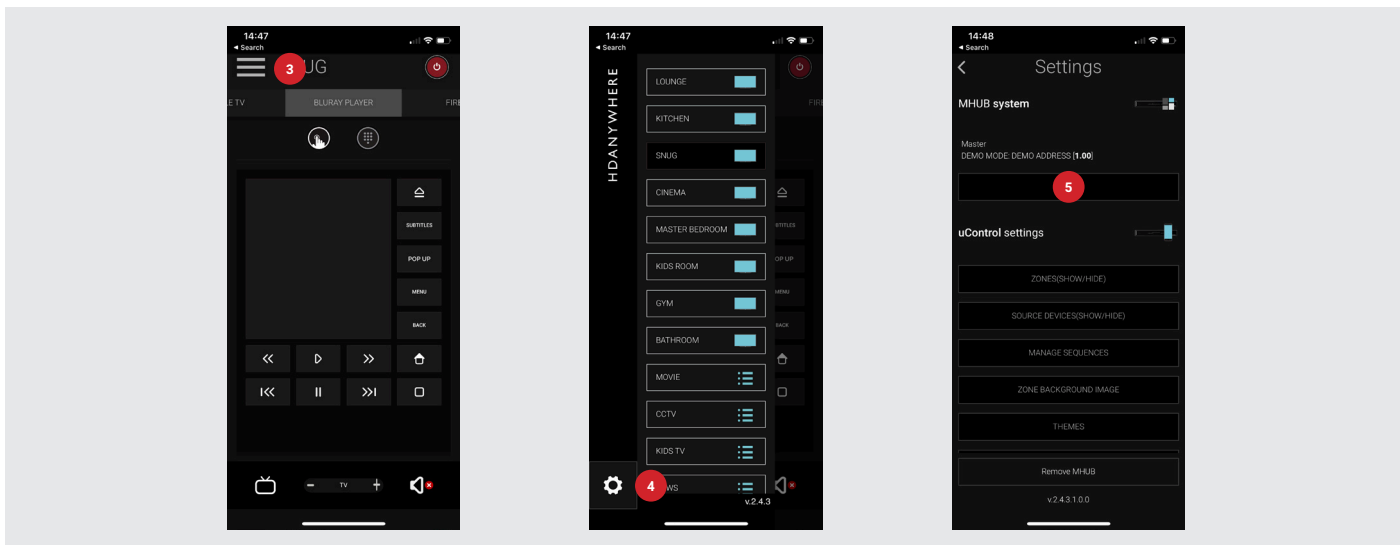

MHUB-OS pages described

Configuration options for MHUB within MHUB-OS are detailed below.

Homepage / Dashboard	The homepage for MHUB-OS. Control input switching, power and toggling ARC mode from this page.
Account Management	<p>Create a HDA Cloud account and register MHUB to extend warranty by 1 year. Registering MHUB on HDA Cloud will allow MHUB to connect to other online services such as Amazon Alexa and will grant permissions to have MHUB remotely managed by your installer (HDA Pro) if you have one. Having this account in place will also allow HDANYWHERE to access technical data from your system to provide better support should you experience any difficulties.</p> <p>HDA Pro pairing: If you are a professional installer and have an approved HDA Pro account then add your details to the HDA Pro area in addition to the HDA Cloud account details to setup MHUB for remote management. Ensure that you have permission from the MHUB owner and that their HDA Cloud account is in place otherwise pairing/remote monitoring will not be possible.</p>
MHUB Setup	This page describes basic configuration settings needed to operate MHUB on a daily basis. It contains a list of MHUB-OS software, firmware and identifying information. From here it is possible to name source devices, create and manage zones, manage output assignment, set time zone, set security PIN and apply a custom LCD message (if applicable).
Network Settings	Manage the network settings for MHUB such as DHCP and WiFi settings.
uControl	Download or delete uControl Packs from HDA Cloud and assign them to input or display receiver IR ports to enable remote control of sources, displays and AVRs. Set the operating mode for the HDMI IR Dongle and test CEC commands to see if your display is supported.
Sequences & Scheduling	A Sequence is a string of individual commands such as (switch to input 1, change channel to 101, mute output A & D) which can be triggered by a single button press or Alexa voice command. Create and test Sequences from this page. Additionally, it is possible to schedule a Sequence so that it executes automatically at a set time or date.
Voice Control	Options to configure voice control for supported devices can be found here.
AV Settings	Manage EDID and video scaling from this page.
Control Drivers	Links to HDANYWHERE Support (http://support.hdanywhere.com).

7.

uControl it.

uControl interface

uControl is MHUB's native method of control which can be used to control all sources, AVRs, displays and other MHUB devices from anywhere in your property.

The following pages describe the main interface areas, their function and how to use them.

1 Tapping this button reveals the zone selector and allows access to the settings menu (see #10-12).

2 This label indicates the zone that you are controlling. All control commands are targeted in this area.

3 Zone power control: this button reveals a sub menu containing all devices available which can be turned on or off. Power buttons can be displayed in two colours describing how you interact with the button: Red) indicating the device power control can be toggled, a tap to turn on and a tap to turn off. Blue) meaning that the power control requires an explicit interaction to turn on or off. Tap to turn on and press and hold for 3 seconds to turn off.

4 Control selector bar. This bar includes all sources that can be controlled in your system. All devices are listed in this bar and navigating between devices can be done by swiping left or right horizontally. Devices can be removed or added back by accessing uControl settings.

5 Control group icon: on smaller devices controls are grouped together for quicker access. If your device has its controls grouped then the icons will appear here, examples are numeric keypads, or playhead controls which are typically grouped together.

6 Control interface. This area is where your control interface is displayed. The control interface will change dynamically depending on the device that you have selected from the control selector bar.

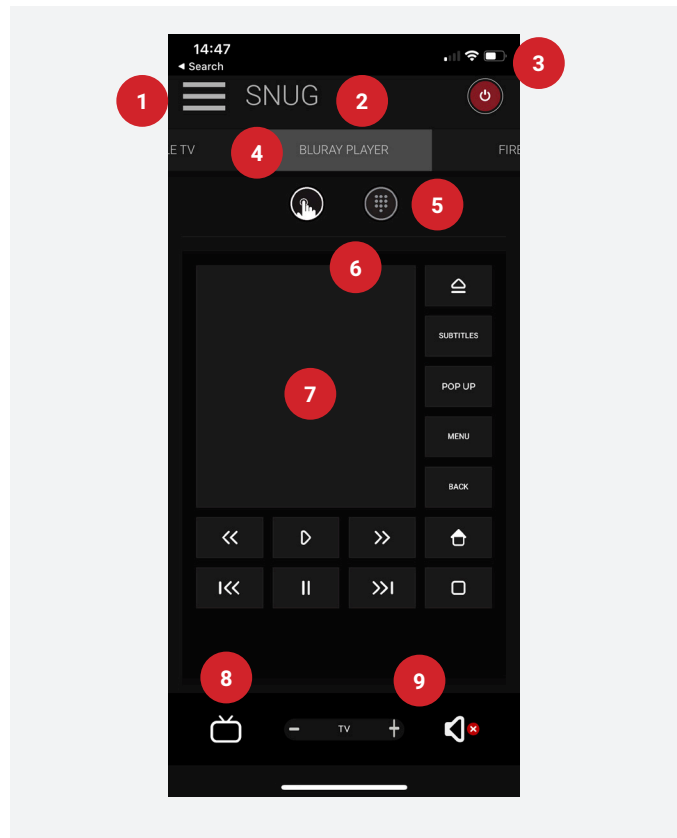

7 Gesture control area will appear in the control interface as a large square or rectangle. This area supports nine control types familiar to all mobile device users. Swipe up, down, left or right to replicate the same command on your device. Tapping acts as an Enter command. Additionally, if supported, then two fingers down will pause and two fingers up will resume. Drawing a chevron to the right will skip forward and a chevron to the left will take you back.

8 Audio selector icon. Tapping this icon will cycle through the different audio devices that are available in that zone.
1. Display audio (TV & speaker icon):
Provides volume/mute control for the display. Pressing and holding the TV icon will reveal ARC options if supported and any audio inputs connected to the MHUB.

2. AVR audio (AVR icon):
If the zone contains an AVR then volume/mute controls will be presented. When selected, all volume commands will be directed to the AVR instead of the display.

9 Volume control: increase or decrease volume by using a slider (MHUB AUDIO only) or tapping the "+" or "-" buttons. Tapping the mute icon will reduce the volume to 0 or put the device in a mute state. Volume commands are targeted depending on what audio device is active as per point #8.

10 Tap to access uControl and MHUB-OS settings for app and MHUB configuration options.

11 Change zones by selecting the zone you wish to control here. If a blue display icon appears then this means that there is display control in that zone. Zones can be reordered or removed by pressing and holding on the zone label and then clicking "Done" which appears near location #10.

12 Execute Sequence. If you have created a Sequence in MHUB-OS then you can make it visible from uControl's setting page. Tapping the Sequence button will execute that Sequence anywhere in the property.

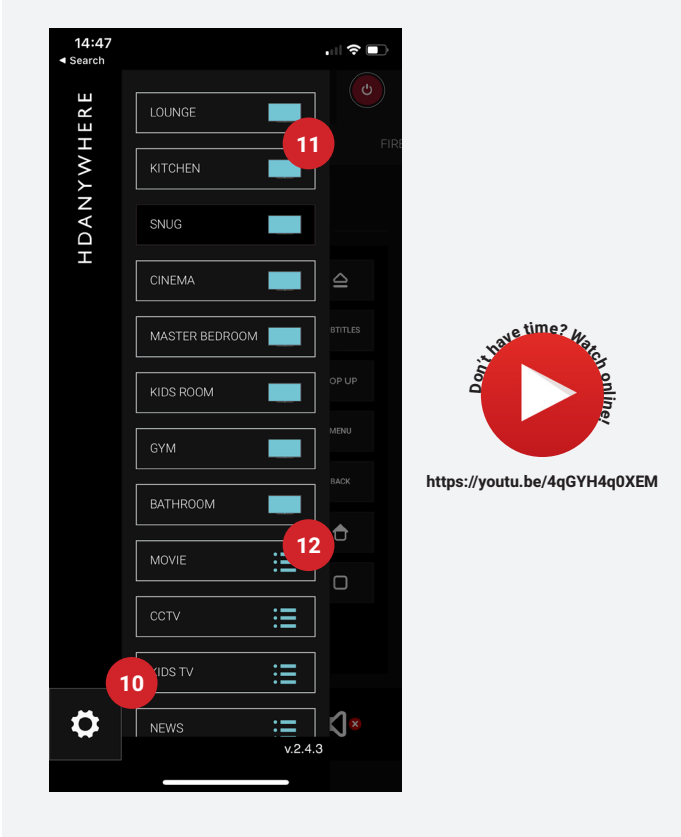

8.

The Legal Bit.

Important information

Terms & Policies, including General Data Protection Regulation (GDPR) and other Data Protection Laws.

During the setup of MHUB, the HDA Pro (Installer) and End-User are required to agree to a set of terms, conditions, rules, policies and license agreements, including the HDANYWHERE Privacy Policy. These terms, notices and policies are, collectively, the "Agreements". By installing or using MHUB, you agree to be bound by the Agreements.

EU Conformity

Hereby, HDANYWHERE declares that this HDMI connectivity device is in compliance with the essential requirements and other relevant provisions of the following Directives: 2006/95/EC (LVD Directive); 2004/108/EC (EMC Directive); 1999/5/EC (R&TTE Directive). The full text of the EU declaration of conformity is available in the compliance section at [HDANYWHERE.com/legals](https://www.hdanywhere.com/legals)

Recycling your device properly

In some areas, the disposal of certain electronic devices is regulated. Make sure you dispose of or recycle your device in accordance with your local laws and regulations.



HDANYWHERE Limited Product (2 Year) Guarantee

WHO WE ARE

1. We are HD CONNECTIVITY LTD trading as HDANYWHERE ("HDA"), a limited company registered under number 06046737 in England and Wales with its registered offices at The Haysfield, Malvern, WR14 1GF, United Kingdom.

OUR GUARANTEE TO YOU

2. We, HDANYWHERE warrant to you, the end user of the HDA hardware (the "Products") that on the date of delivery of the Products to you, and from that date to the end of the period specified in your user manual or to the end of the period as extended by paragraph 3 if applicable (the "Guarantee Period"), the Products shall:

- (a) match any description that has been provided to you;
- (b) be free from any significant defects in their design, the materials used to make them, and the way they are made;
- (c) be of satisfactory quality (within the meaning of the Consumer Rights Act 2015); and
- (d) be fit for any purpose held out by us.

We offer this guarantee to all our customers who are resident and have an address in Great Britain and Northern Ireland.

EXTENDING YOUR GUARANTEE

3. On registering your Products with HDA Cloud, the guarantee offered in paragraph 2 by us will automatically extend for a period of one year, provided that your registration takes place within 30 days from the date of delivery. The one year guarantee extension starts automatically from the date that the original guarantee ends.

HOW TO CLAIM ON YOUR GUARANTEE AND YOUR REMEDIES

4. Subject to paragraphs 5 and 6 of this guarantee, Your sole remedies under Our guarantee to You are as follows: (i) Up to 30 days: we will repair or replace your Products or provide you with a full refund of the price of the defective Products at your option.

(ii) Up to 6 Months: we will repair or replace your Products. If we are unable to repair or replace your Products we will provide you with a full refund of the price of the defective Products.

(iii) Up to 3 (4) Years: we will repair or replace your Products. If we are unable to repair or replace your Products we will provide you with a partial refund of the price of the defective Products based upon the devaluation of the Products since the time of purchase.

5. In order to claim under the guarantee given to you in paragraph 2 you will need to:

- (a) give us notice in writing of your intention to claim under the guarantee during the Guarantee Period, and do so within a reasonable time after finding that some or all of the Products do not comply with the guarantee set out in paragraph 2;
- (b) show that the Products that you claim are defective, have been examined by a HDA Pro or other authorised or suitably qualified installer, and that they have[MG3] confirmed in writing that the suspected defect in the Products stems solely from a fault in the HDA hardware;
- (c) give us a reasonable opportunity to examine the Products in question;
- (d) provide us with an order number and a dated sales or delivery receipt from an HDA Distributor, HDA Pro or other authorised dealer, reseller or installer of the Products.
- (e) obtain from us in advance of returning the Products a return merchandise authorisation and/or case number[MG4]; and
- (f) (if asked to do so by us) return such Products to our place of business at our cost.

CIRCUMSTANCES WHERE YOUR GUARANTEE DOESN'T APPLY

6. We shall not be liable for the Products' failure to comply with the guarantee set out in paragraph 2 in any of the following events:

- (a) If you make any further use of the Products after giving us notice of an issue in accordance with paragraph 5;

- (b) the defect arises because you failed to follow our oral or written instructions as to the storage, installation, use and maintenance of the Products;
- (c) the defect arises as a result of your use of the Products with any other software or hardware that is not compatible with the Products;
- (d) the products are used by you for any commercial purpose, including rental or demonstrative purposes;
- (e) you alter or repair the Products without the written consent of HDA;
- (f) the defect arises as a result of an act of god, fair wear and tear, or your misuse, abuse, unreasonable use, wilful damage, negligence, or abnormal storage of the Products or by any other causes unrelated to defective hardware or manufacturing;
- (g) where the serial number has been altered, defaced or removed;
- (h) where the warranty seal on the system has been altered, defaced or removed; or
- (i) where the Products differ from their description as a result of changes made to ensure they comply with applicable statutory or regulatory requirements.

TRANSFERRING YOUR GUARANTEE TO SOMEONE ELSE

7. HDA will not accept any liability under such guarantee unless you are the original customer or can produce a letter or chain of letters from the original customer and subsequent customers (where appropriate) transferring the benefit of the guarantee to you.]

PRODUCTS THAT ARE NOT COVERED BY THIS GUARANTEE

8. This guarantee does not cover products sold and clearly marked "as is", "B-grade", or with faults. This guarantee does not apply to any system software that is preinstalled in the HDA hardware, or is subsequently provided via update or upgrade releases. Any and all HDA software is licensed to you under the terms of a separate end user licence agreement found here: [EULA Link]

HOW THIS GUARANTEE WORKS WITH OUR EULA

9. We may void this guarantee if we reasonably believe that the HDA system has been used in a manner that violates terms of our separate End User Licence Agreement (EULA) for the HDA software. You assume all-risk and liabilities associated with the use of third party products in conjunction with the Products.

YOUR STATUTORY RIGHTS

10. This guarantee is in addition to your statutory rights (including under the Consumer Rights Act) which are not affected by this guarantee

GENERAL TERMS OF THIS GUARANTEE

11. Except as provided in this guarantee, we shall have no liability to you in respect of the Products' failure to comply with the guarantee set out in paragraph 2.

12. We reserve the right to amend or withdraw this guarantee at any time although for the avoidance of doubt any guarantees that are in existence at such a time will be honoured.

13. These Conditions shall apply to any repaired or replacement Product supplied by us.

GUARANTEE CONTACT INFORMATION

To contact (support@hdanywhere.com) or call HDANYWHERE Technical Support (call charges will depend on your telephone provider. Please check with your operator for exact charges). The team is available 9am - 5pm weekdays.

To help us handle your query promptly, please have your invoice number and model SKU and serial ready.

HDANYWHERE™

Let us know what you think.

We would love to hear how we could further improve our products and services.
If we can make something better, please let us know!

support@hdanywhere.com

Copyright © HDANYWHERE.

HDANYWHERE™ is a trading name of HD Connectivity Ltd.

Registered in England & Wales 06046737 VAT 913222367

HDANYWHERE assumes no responsibility for any inaccuracies that may be contained in this document. In no event will HDANYWHERE be liable for direct, indirect, special, incidental, or consequential damages resulting from any defect or omission in this document, even if advised of the possibility of such damages.