

COPYRIGHT © Hangzhou EZVIZ Software Co., Ltd.. ALL RIGHTS RESERVED.

Any and all information, including, among others, wordings, pictures, graphs are the properties of Hangzhou EZVIZ Software Co., Ltd. (hereinafter referred to as “EZVIZ”). This user manual (hereinafter referred to as “the Manual”) cannot be reproduced, changed, translated, or distributed, partially or wholly, by any means, without the prior written permission of EZVIZ. Unless otherwise stipulated, EZVIZ does not make any warranties, guarantees or representations, express or implied, regarding to the Manual.

About this Manual

The Manual includes instructions for using and managing the product. Pictures, charts, images and all other information hereinafter are for description and explanation only. The information contained in the Manual is subject to change, without notice, due to firmware updates or other reasons. Please find the latest version in the EZVIZ™ website (<http://www.ezviz.com>).

Revision Record

New release – January, 2022

Trademarks Acknowledgement

EZVIZ™, ™, and other EZVIZ’s trademarks and logos are the properties of EZVIZ in various jurisdictions. Other trademarks and logos mentioned below are the properties of their respective owners.

Legal Disclaimer

TO THE MAXIMUM EXTENT PERMITTED BY APPLICABLE LAW, THE PRODUCT DESCRIBED, WITH ITS HARDWARE, SOFTWARE AND FIRMWARE, IS PROVIDED “AS IS”, WITH ALL FAULTS AND ERRORS, AND EZVIZ MAKES NO WARRANTIES, EXPRESS OR IMPLIED, INCLUDING WITHOUT LIMITATION, MERCHANTABILITY, SATISFACTORY QUALITY, FITNESS FOR A PARTICULAR PURPOSE, AND NON-INFRINGEMENT OF THIRD PARTY. IN NO EVENT WILL EZVIZ, ITS DIRECTORS, OFFICERS, EMPLOYEES, OR AGENTS BE LIABLE TO YOU FOR ANY SPECIAL, CONSEQUENTIAL, INCIDENTAL, OR INDIRECT DAMAGES, INCLUDING, AMONG OTHERS, DAMAGES FOR LOSS OF BUSINESS PROFITS, BUSINESS INTERRUPTION, OR LOSS OF DATA OR DOCUMENTATION, IN CONNECTION WITH THE USE OF THIS PRODUCT, EVEN IF EZVIZ HAS BEEN ADVISED OF THE POSSIBILITY OF SUCH DAMAGES.

TO THE MAXIMUM EXTENT PERMITTED BY APPLICABLE LAW, IN NO EVENT SHALL EZVIZ’S TOTAL LIABILITY FOR ALL DAMAGES EXCEED THE ORIGINAL PURCHASE PRICE OF THE PRODUCT.

EZVIZ DOES NOT UNDERTAKE ANY LIABILITY FOR PERSONAL INJURY OR PROPERTY DAMAGE AS THE RESULT OF PRODUCT INTERRUPTION OR SERVICE TERMINATION CAUSED BY: A) IMPROPER INSTALLATION OR USAGE OTHER THAN AS REQUESTED; B) THE PROTECTION OF NATIONAL OR PUBLIC INTERESTS; C) FORCE MAJEURE; D) YOURSELF OR THE THIRD PARTY, INCLUDING WITHOUT LIMITATION, USING ANY THIRD PARTY’S PRODUCTS, SOFTWARE, APPLICATIONS, AND AMONG OTHERS.

REGARDING TO THE PRODUCT WITH INTERNET ACCESS, THE USE OF PRODUCT SHALL BE WHOLLY AT YOUR OWN RISKS. EZVIZ SHALL NOT TAKE ANY RESPONSIBILITIES FOR ABNORMAL OPERATION, PRIVACY LEAKAGE OR OTHER DAMAGES RESULTING FROM CYBER ATTACK, HACKER ATTACK, VIRUS INSPECTION, OR OTHER INTERNET SECURITY RISKS; HOWEVER, EZVIZ WILL PROVIDE TIMELY TECHNICAL SUPPORT IF REQUIRED. SURVEILLANCE LAWS AND DATA PROTECTION LAWS VARY BY JURISDICTION. PLEASE CHECK ALL RELEVANT LAWS IN YOUR JURISDICTION BEFORE USING THIS PRODUCT IN ORDER TO ENSURE THAT YOUR USE CONFORMS TO THE APPLICABLE LAW. EZVIZ SHALL NOT BE LIABLE IN THE EVENT THAT THIS PRODUCT IS USED WITH ILLEGITIMATE PURPOSES.

IN THE EVENT OF ANY CONFLICTS BETWEEN THE ABOVE AND THE APPLICABLE LAW, THE LATTER PREVAILS.

Table of Contents

Instruction	1
Packing List	1
Overview	2
Lock Installation	3
Switch Lever Handle Direction (Optional)	3
Switch Lock Latch Bolt (Optional)	4
Installation Steps	4
Lock Settings	7
Activate Lock	8
Enter Menu	8
Menu Index	8
Add Fingerprint/Password/Card	8
Delete Fingerprint/Password/Card	10
Clear Fingerprint/Password/Card	12
Initialize	12
Volume Control	12
Lock Using	13
Unlock	13
Operation and Management	13
Get the EZVIZ App	14
Add Lock to EZVIZ	15
Connect Gateway to Power Source	15
Connect Gateway to Network	15
Add Gateway to EZVIZ	16
Add Lock to EZVIZ	16
Maintenance	17
Daily Maintenance	17
FAQ	17
Initiatives on the Use of Video Products	19

Instruction

- The installation of EZVIZ Smart Fingerprint Lock (hereinafter referred as to "lock") impacts its normal operation and service life. It is recommended to let professionals install, and drill hole for lock set in accordance with hole templet in appendix.
- It is recommended to remove the lock if your house is under decoration, and reinstall it after decoration in case of lock damage and service life reduction.
- Please note that disinfectant may cause damage to the lock body.
- Once initialized completed, the lock will clear all user information. After lock installation and configuration, please add fingerprint, password or card as needed.
- When battery voltage is low after using for a while, low voltage alarm alerts. Replace battery timely and pay attention to positive and negative poles.
- If you leave home or do not use lock for a long time, keep mechanical key with you, and do not leave it indoors. You should take battery out to ensure lock service life.
- For users with flat or thin fingerprint, it is recommended to use thumb to register fingerprint for increasing success rate, and register more than one fingerprint with the same user.
- The lock accommodates up to 50 fingerprints, 50 passwords and 50 cards.

Packing List

1	Front Panel	×1
2	Rear Panel	×1
3	Lock Body	×1
4	Home Gateway	×1
5	Square Rod	×1
6	Card	×2
7	Hole Templet	×1
8	Standard Screw Bag	×1
9	Lock Body Screw Bag	×1
10	Key Bag	×1
11	AA-sized Battery	×4
12	Regulatory Information	×1
13	Quick Start Guide	×1

Overview



Lock Installation

Switch Lever Handle Direction (Optional)

1. Switch Lever Handle Direction

- Take off the rubber and remove the reversing screw with screwdriver.
- Rotate the lever handle 180 degrees upwards.
- Screw the reversing screw into the opposite screw hole.

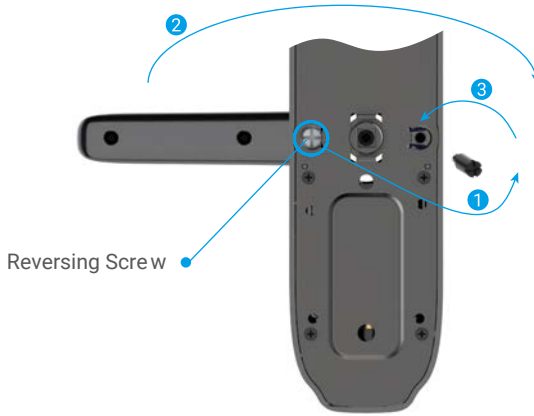

2. Confirm Clutch Direction

- Front panel: Insert square rod into sleeve and lift lever handle. Rotate sleeve 90 degrees if lever handle idles.
- Rear panel: Turn on the anti-peephole button. Insert square rod into sleeve and lift lever handle. Rotate sleeve 180 degrees if lever handle idles.

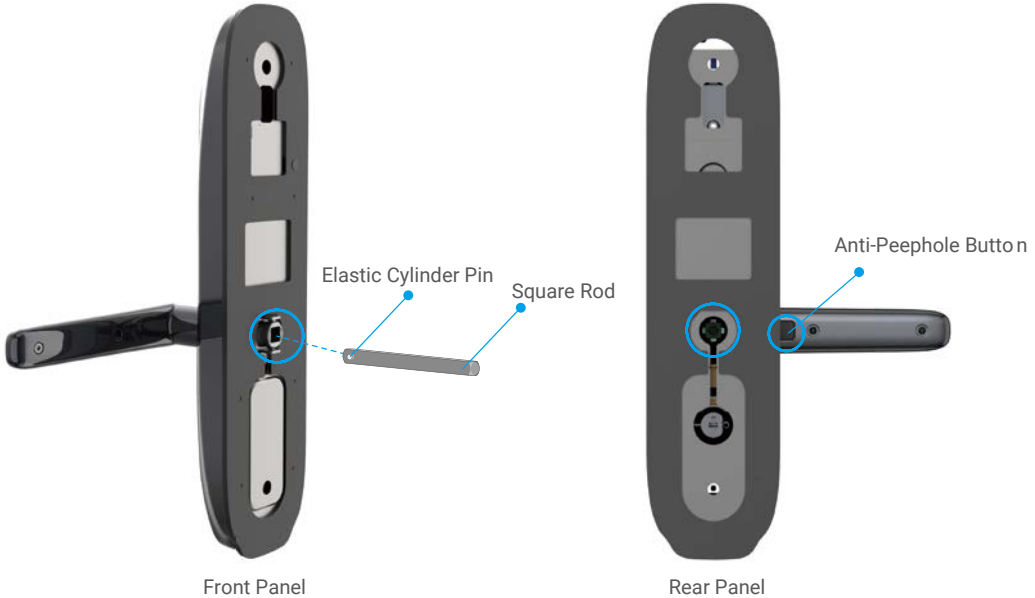

Switch Lock Latch Bolt (Optional)

- 1 Uplift the metal here.
- 2 Rotate the latch bolt 180 degrees. Turn the central part 90 degrees and tuck it in.

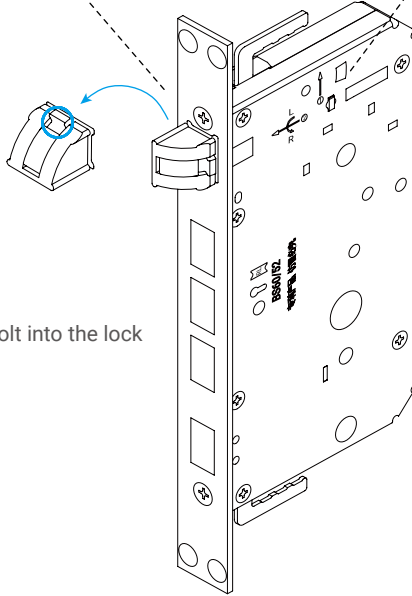

- 3 Push the latch bolt into the lock body.

Installation Steps

- 1
 - The standard accessories for this product support installation for 40mm-50mm wooden doors. If the thickness of the door is beyond this range, please contact your local dealer.
 - When fixing front and rear panel, do not press internal connection cable.
 - When installing front and rear panel, handle with care in case of any panel damage.

1. Drill Hole

The product is applicable to wooden door and burglar-proof metal door. Drill hole in accordance with hole templet in packing list.



2. Install

Please tap  to watch the installation video.



- 1 Fix lock body into door panel with screws.

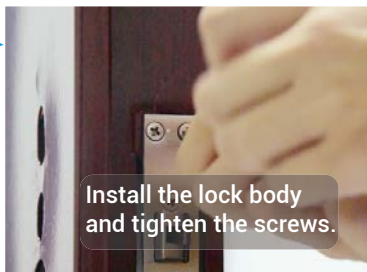

- 2 Insert square rod into front panel and install the front panel into door as shown below.

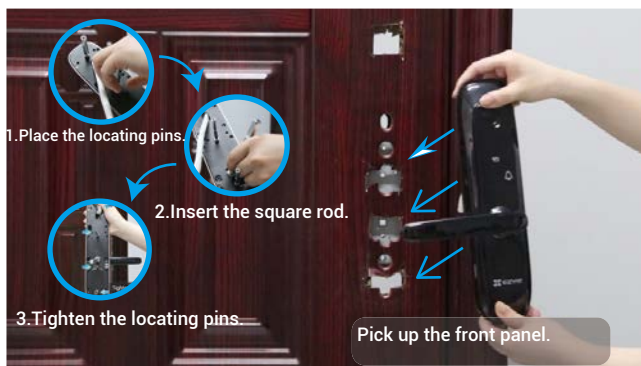

- 3 Insert the front panel in the correct position and test normal operations of latch bolt and handle.

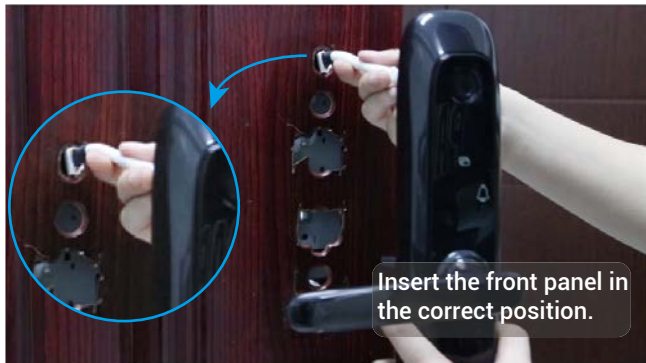

- 4 Fix the fixed plate and rubber pad into the door with ① locating pin and ② tighten sleeve.

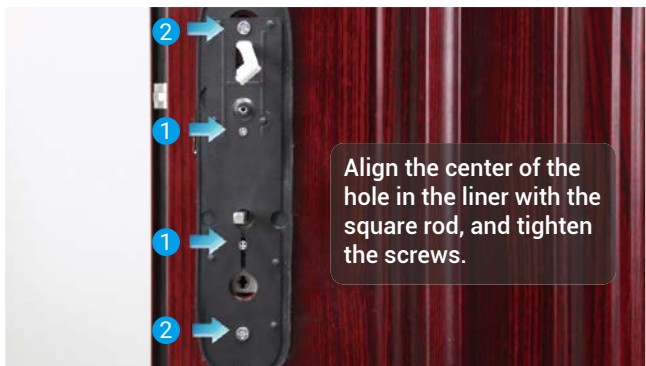

- 5 Connect the front and the rear panels with the cable.



- 6 With the secure knob keeping upright, fix the rear panel with screws as shown below.



- 7 Place the batteries into the rear panel.

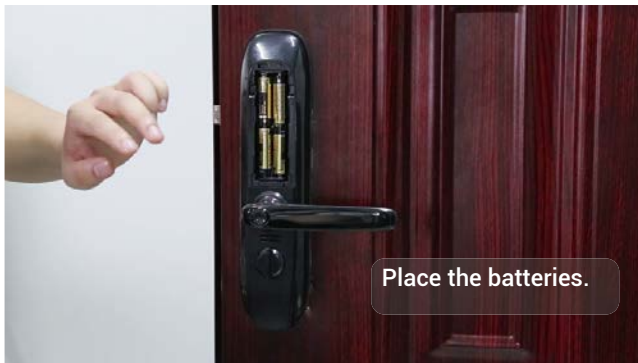

- 8 Test your passwords, fingerprint and proximity card, and then the installation is finished.

Lock Settings

After installation, remove back cover of battery seat and install 4*AA-sized batteries. Then you can set the lock as needed.

Please tap  to watch the setup video.



- Please remove protective film from lock before first use.
- Please note that disinfectant may cause damage to the lock body.

Activate Lock

Touch keypad area to activate the lock.

Enter Menu

Press 3571# to enter menu.

- In initial state, enter short code for settings.
- In non-initial state, verify with administrator's fingerprint, password or card first. Then enter short code for settings.

Menu Index

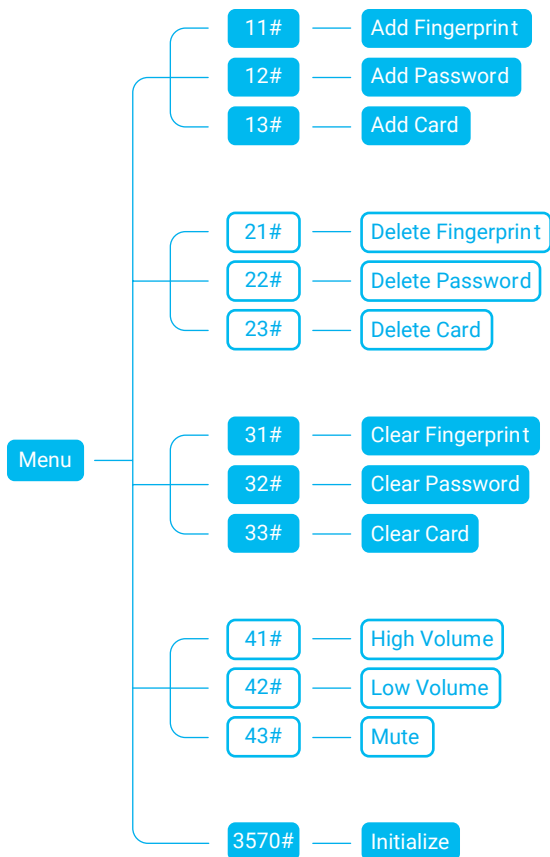

- i** After every successful setting, you will return to the menu. Then you can enter short code again to set or press * to exit.

Add Fingerprint/Password/Card

Add Fingerprint

- i** • The number of times will be displayed on the keypad each time you touch the fingerprint reader.
- Please remember your fingerprint number well in case you want to delete the fingerprint in the future.
- Fingerprint which has been added cannot be added again.

1 After entering the menu, press 11# to add fingerprint.

2 Touch fingerprint reader. Then touch again after voice prompt and repeat the operation for 5 times to confirm. The fingerprint number will flash on the keypad when complete.



Fingerprint Collection

When collecting fingerprint, please adjust your finger to maximize the fingerprint contact surface as shown below, which helps to improve fingerprint verification success rate.

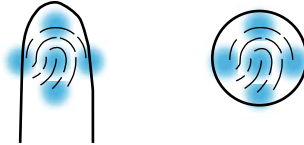

Add Password

- 1 Please remember your password number well in case you want to delete the password in the future.
- Password which has been added cannot be added again.

1 After entering the menu, press 12# to add password.

2 Enter password (6 to 10 digits) and press #. Then enter password and press # again to confirm. The password number will flash on the keypad when complete.



Add Card

- 1 Please remember your card number well in case you want to delete the card in the future.
- Card which has been added cannot be added again.

1 After entering the menu, press 13# to add card.

2 Swipe card. The card number will flash on the keypad when complete.



Delete Fingerprint/Password/Card

Delete Fingerprint

- i** The current verified fingerprint cannot be deleted.
For example, if you verify with fingerprint 1, then fingerprint 1 cannot be deleted.
- 1** After entering the menu, press 21# to delete **2** Enter fingerprint number and press #. fingerprint.



- 3** The fingerprint number flashes and then press #.

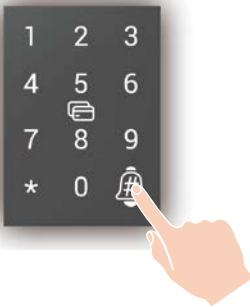

Delete Password

- i** The current verified password cannot be deleted.
For example, if you verify with password 1, then password 1 cannot be deleted.

❶ After entering the menu, press 22# to delete password.



❷ Enter password number and press #.



❸ The password number flashes and then press #.

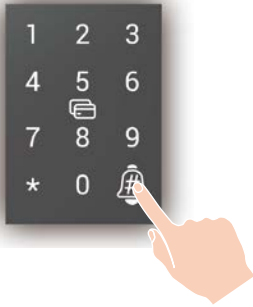

Delete Card

i The current verified card cannot be deleted.
For example, if you verify with card 1, then card 1 cannot be deleted.

❶ After entering the menu, press 23# to delete card.



❷ Enter card number and press #.



❸ The card number flashes and then press #.



Clear Fingerprint/Password/Card

i The current verified method cannot be cleared.
For example, if you verify with fingerprint, then fingerprints cannot be cleared.

- ➊ After entering the menu, press 31# to clear fingerprints, press 32# to clear passwords, press 33# to clear cards.
- ➋ Press # to confirm.

Initialize

- ➊ After entering the menu, press 3570# to initialize.
- ➋ Press # to confirm.

Volume Control

After entering the menu, press 41# to select High Volume, press 42# to select Low Volume, press 43# to select Mute.

i Only key sound and verification sound can be muted.

Lock Using

Please tap  to watch the management video.



Unlock

Normal Unlock



Fingerprint Unlock



Password Unlock



Key Unlock



Card Unlock

-  When opening the door by mechanical key, rotate the key and down press the handle.
- Please touch the keypad area to activate the lock before open the door by password.
- For your privacy security, it is recommended to change passwords and clean keypad area regularly in case of remaining marks.

Scramble Password

The smart lock applies scramble password function. Scramble password increases safety and avoid password being peeped.

When entering password, you can enter any random number among where there has the right password. Max. length: 20 digits (scramble password + right password).

For example: the right password is 123456, you can enter xxx123456xxx and end by "#" to confirm, and the door will unlock.

Operation and Management

Emergency Power Supply

When batteries are out of power, connect lock's micro-USB emergency power supply interface with power bank (or phone supports OTG) to charge lock through micro-USB charging line, and then unlock the door.



Install Battery

1. Install battery: remove battery cover, install 4*AA-sized batteries in battery seat, and then tighten battery cover.
2. Note: install correct batteries in case of explosion.
 - When not using batteries for a long time, remove them from battery seat.
 - Do not use new batteries with old ones at the same time.
 - Do not place battery with the (+) and (-) in the wrong way around.
 - Dispose used batteries according to the local environmental protection law.

Alarms

1. Tamper Alarm

Once being dismantled by force, the lock will send out alarm lasting about one minute.

2. System Locked Alarm

Verify with wrong fingerprint, password or card 5 times in a row, the system will be locked for 3 minutes.

3. Low Voltage Alarm

Once battery voltage is low, the voice prompt will remind you to replace batteries.

Restore to Factory Settings

1. Remove the battery cover of rear panel and take out batteries.
2. Press reset button for 5 seconds with needle-resemble object, meanwhile put back batteries in the battery seat.
3. Release reset button and press "#" to confirm after voice prompts.

Get the EZVIZ App

1. Connect your mobile phone to Wi-Fi (suggested).
2. Download and install the EZVIZ app by searching for "EZVIZ" in the App Store or Google Play™.
3. Launch the app and register an EZVIZ user account.

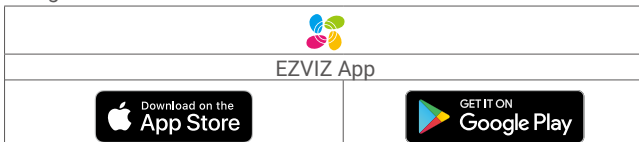

- i** If you have already used the app, please make sure that it is the latest version. To find out if an update is available, go to the app store and search for "EZVIZ".

Add Lock to EZVIZ

Please add lock and gateway to EZVIZ by following steps:

Select Appropriate Location for Gateway

- The gateway needs to be plugged in.
- To ensure that the connection between the gateway and sub devices is stable, please place the gateway at the center of the sub devices, and the distance between the gateway and the router should be ≤ 6 meters.
- There should be no metal obstacles and walls between the gateway and sub devices, and the gateway and the router.
- Do not place any gateway or detector on the top of the router.

Connect Gateway to Power Source

Plug the gateway in. When start up the gateway for the first time, the LED indicator ring turns from solid orange to fast-flashing white, which means that the gateway has entered network configuring mode.

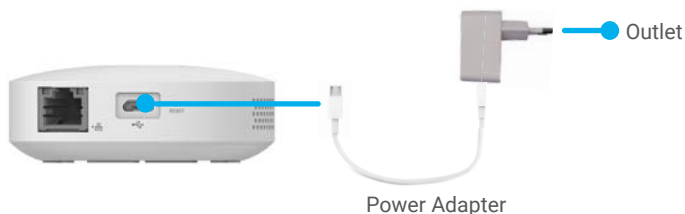

Connect Gateway to Network

- Wired network is recommended. You need to connect the gateway to the LAN port of the router with power cable (purchase separately) as displayed in the figure below.

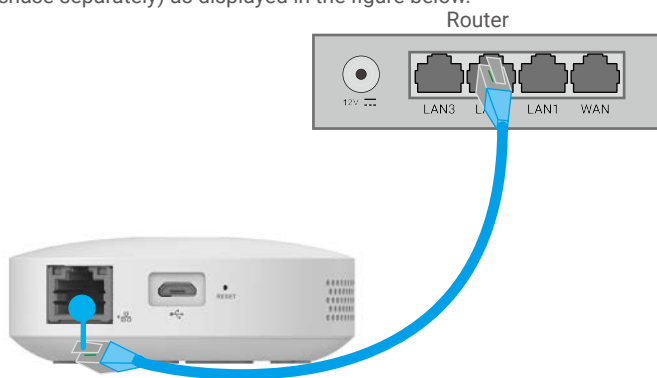

- You can also use wireless network. Scan the QR code at the bottom of the gateway with the EZVIZ app, and then connect the gateway to Wi-Fi by following the on-screen instructions.
- ① If Wi-Fi connection failed, or you want to connect the gateway to another Wi-Fi, you need to make the gateway offline first. Press and hold the function key for over 4 seconds until you hear the voice prompt, and then connect the gateway to Wi-Fi by following the on-screen instructions.

Add Gateway to EZVIZ

i The app interface may be different due to version update, and the interface of the app you installed on your phone shall prevail.

1. Log in to your account through EZVIZ app, tap the device adding icon and then the QR code scanning interface will be displayed.

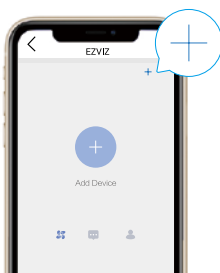

2. Scan the QR code at the bottom of the gateway.

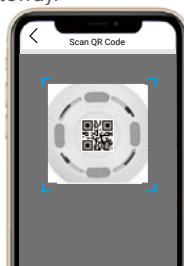

3. Add the gateway by following the wizard on the app.

Add Lock to EZVIZ

1. Return the home page of the EZVIZ app, tap the device adding icon and then the QR code scanning interface will be displayed.

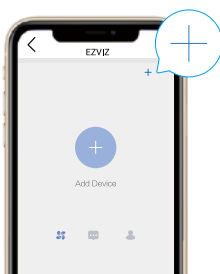

2. Scan the QR code at the back of the battery cover.



3. Press and hold the **RESET Hole** for 3 seconds with a pin until you hear a voice prompt. When the number **5** on the keypad flashes, you can add the lock to the gateway.

① Press * to exit the adding mode.

4. Choose your gateway, add the lock to the gateway by following the wizard on the app.

Maintenance

Daily Maintenance

- Do not let lock contact with corrosive materials to avoid lock damage and impacting its gloss.
- As a key part of the lock, do not hang any object on the lever handle for its flexibility directly impacting the use of the lock.
- If door deforms, it increases friction that combined latch bolt entering the box strike plate and bolt cannot extend fully. At this time, adjusting strike plate position is needed.
- After using fingerprint reader for a long time, its surface may be stained or wet. Wipe gently with a soft and dry cloth.
- Replace batteries immediately once battery voltage is low to ensure the normal use of the lock. Pay attention to the positive and negative poles of batteries when replacing them.
- Keep the mechanical key properly.
- Do not scratch the fingerprint reader and keypad surface with hard, sharp objects.
- When collecting fingerprint, press your finger on the reader horizontally.
- Ask professionals to check the lock if it is not flexible or cannot be held in correct position.
- Keep lubricant in the rotating part of the lock to keep it rotate smoothly and prolong its service life.
- It is recommended to check the lock once every six months or one year, and check whether fixed screws are loose.
- Apply a small amount of graphite powder or pencil powder into lock cylinder slot to ensure the key is inserted and removed smoothly on regular basis (one year or six months). However, do not apply any grease to lubricate in case of grease sticking to the pin tumbler spring.

FAQ

Problem	Cause	Solution
Door cannot be opened successfully through verifications by fingerprint, password or card.	Lock installation problem.	Ask professionals to check the lock.
	When verified by fingerprint or password, lever handle doesn't return to its position.	Return lever handle to its position, and then re-enter password or fingerprint.

Problem	Cause	Solution
Door cannot be opened with mechanical key.	Incorrect mechanical key.	Use correct mechanical key.
	Lock cylinder damaged.	Ask professionals to check the lock and replace the damaged components after opening door by other methods.
	Lock body damaged.	
	The key does not insert to end.	
When unlocking by fingerprint, the door cannot be opened.	The fingerprint is invalid.	Unlock the door by valid fingerprint, password or mechanical key.
	The fingerprint has been deleted.	
	Large deviation of valid fingerprint.	Re-verify fingerprint, press finger on the reader horizontally to reduce deviation; or unlock the door by password or mechanical key.
	The fingerprint is damaged.	Re-add a fingerprint (it is recommended to register more than one fingerprint for the same user); or unlock the door by password or mechanical key.
	The fingers are too dry, wet or dirty.	Re-verify fingerprint after fingers are in proper condition.
When unlocking by fingerprint, the door cannot be opened.	The fingerprint deforms for applying too much pressure when collecting fingerprint.	Re-verify fingerprint in correct way.
	The fingerprint doesn't fully touch with fingerprint reader for applying little pressure when collecting fingerprint.	
Verified by fingerprint, password and card successfully, but motor doesn't work, and door cannot be opened.	Connection line loosens.	Ask professionals to check the lock, and replace damaged components.
	Motor fault.	
No response of keypad.	Batteries are out of power or installed in a wrong way.	Unlock the lock through external power supply or mechanical key, and check batteries.
	Connection line between front lock body and rear one loosens.	Ask professionals to check the lock after opening door with mechanical key.
	Keypad damaged.	
No response from fingerprint reader.	Fingerprint reader damaged.	Ask professionals to check the lock and replace damaged components after opening door by other methods.
The lock remains open, and cannot be used normally.	Clutch components fault.	Ask professionals to check the lock.
	The lock has entered remaining open mode	Verification by fingerprint, password or card to cancel remaining open mode.
The main bolt cannot be extended, or extend partially by uplifting lever handle.	The door deforms, and main bolt doesn't align with the hole in the strike plate.	Ask professionals to check the lock

Initiatives on the Use of Video Products

Thank you for choosing EZVIZ products.

Technology affects every aspect of our life. As a high-tech company, we are increasingly aware of the role technology plays in improving business efficiency and quality of life, but at the same time, the potential harm of its improper usage. For example, video products are capable of recording real, complete and clear images. This provides a high value in retrospect and preserving real-time facts. However, it may also result in the infringement of a third party's legitimate rights and interests if improper distribution, use and/or processing of video data takes place. With the philosophy of "Technology for the Good", EZVIZ requests that every end user of video technology and video products shall comply with all the applicable laws and regulations, as well as ethical customs, aiming to jointly create a better community.

Please read the following initiatives carefully:

1. Everyone has a reasonable expectation of privacy, and the installation of video products should not be in conflict with this reasonable expectation. Therefore, a warning notice shall be given in a reasonable and effective manner and clarify the monitoring range, when installing video products in public areas. For non-public areas, a third party's rights and interests shall be evaluated when installing video products, including but not limited to, installing video products only after obtaining the consent of the stakeholders, and not installing highly-invisible video products.

2. The purpose of video products is to record real activities within a specific time and space and under specific conditions. Therefore, every user shall first reasonably define his/her own rights in such specific scope, in order to avoid infringing on a third party's portraits, privacy or other legitimate rights.

3. During the use of video products, video image data derived from real scenes will continue to be generated, including a large amount of biological data (such as facial images), and the data could be further applied or reprocessed. Video products themselves could not distinguish good from bad regarding how to use the data based solely on the images captured by the video products. The result of data usage depends on the method and purpose of use of the data controllers. Therefore, data controllers shall not only comply with all the applicable laws and regulations and other normative requirements, but also respect international norms, social morality, good morals, common practices and other non-mandatory requirements, and respect individual privacy, portrait and other rights and interests.

4. The rights, values and other demands of various stakeholders should always be considered when processing video data that is continuously generated by video products. In this regard, product security and data security are extremely crucial. Therefore, every end user and data controller, shall undertake all reasonable and necessary measures to ensure data security and avoid data leakage, improper disclosure and improper use, including but not limited to, setting up access control, selecting a suitable network environment (the Internet or Intranet) where video products are connected, establishing and constantly optimizing network security.

5. Video products have made great contributions to the improvement of social security around the world, and we believe that these products will also play an active role in more aspects of social life. Any abuse of video products in violation of human rights or leading to criminal activities are contrary to the original intent of technological innovation and product development. Therefore, each user shall establish an evaluation and tracking mechanism of their product application to ensure that every product is used in a proper and reasonable manner and with good faith.