

# CP.J4 ESA

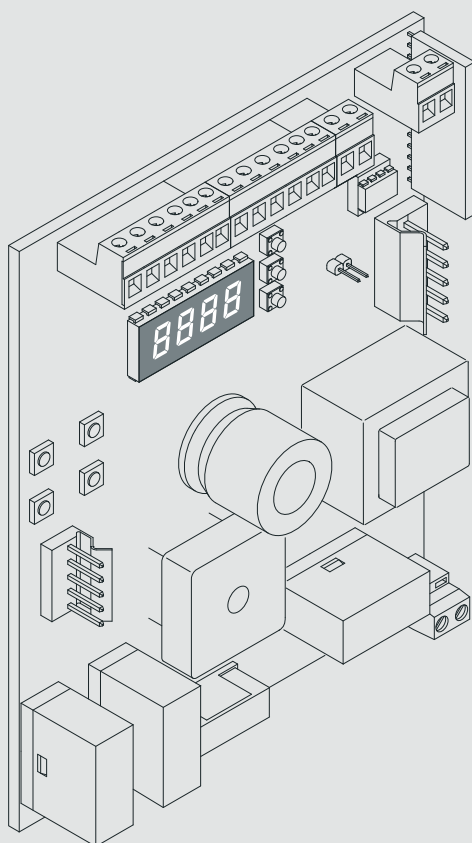

**BENINCA**<sup>®</sup>  
TECHNOLOGY TO OPEN

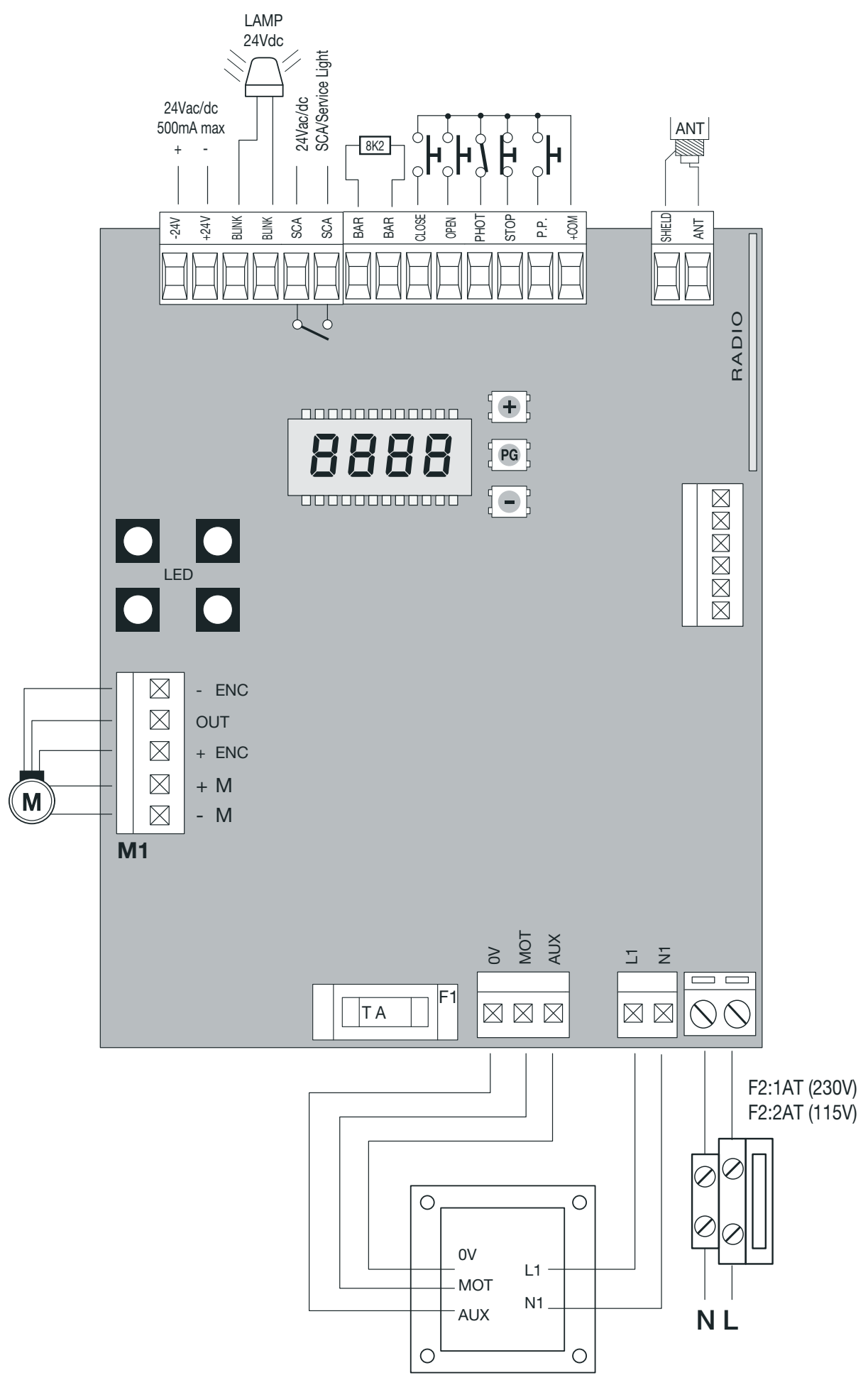



2

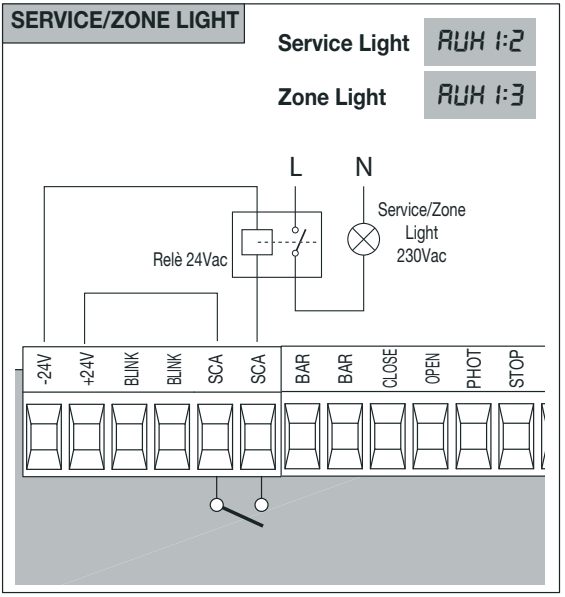
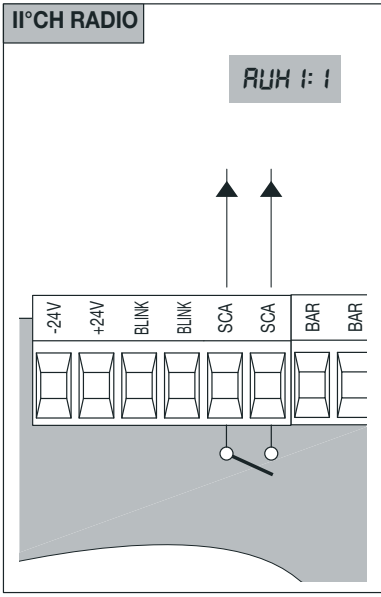
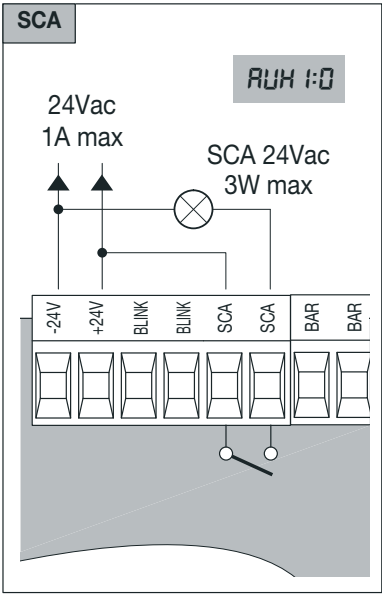

3

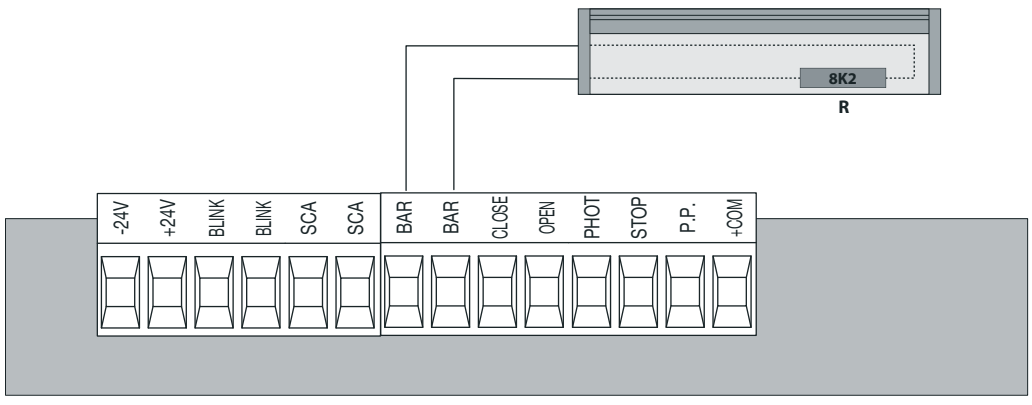

4

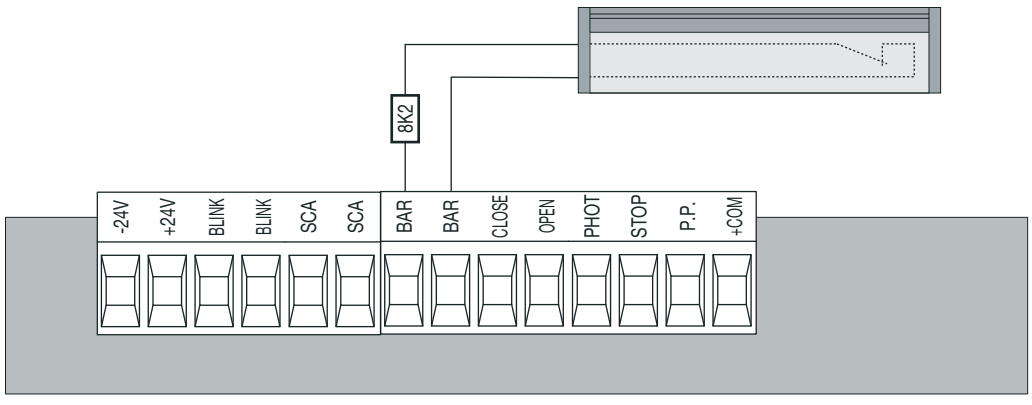

## EC Declaration of Conformity

Pursuant to Directives 2004/108/CE(EMC); 2006/95/CE(LVD)

Manufacturer:

**Automatismi Benincà SpA.**

Address:

**Via Capitello, 45 - 36066 Sandrigo (VI) – Italy**

It is hereby stated that the item:

**Control unit for 1 motor, 24VDC, for sectional doors: CPJ4 ESA**

it is compliant with provisions of the following other EC Directives:

• **DIRECTIVE 2004/108/EC OF THE EUROPEAN PARLIAMENT AND OF THE COUNCIL** of 15 December 2004, on the harmonisation of the laws of Member States relating to electromagnetic compatibility and which cancels Directive 89/336/EEC, according to the following harmonised regulations:

EN 61000-6-2:2005, EN 61000-6-3:2007.

• **DIRECTIVE 2006/95/EC OF THE EUROPEAN PARLIAMENT AND OF THE COUNCIL** of 12 December 2006, on the harmonisation of the laws of Member States relating to electrical equipment designed for use with certain voltage limits, according to the following harmonised regulations:

EN 60335-1:2002 + A1:2004 + A11:2004 + A12:2006 + A2:2006 + A13:2008; EN 60335-2-103:2003.

if applicable:

• **DIRECTIVE 1999/5/EC OF THE EUROPEAN PARLIAMENT AND OF THE COUNCIL** of 9 March 1999 on radio equipment and telecommunications terminal equipment and the mutual recognition of their conformity, according to the following harmonised standards: ETSI EN 301 489-3 V1.4.1 (2002) + ETSI EN 301 489-1 V1.4.1 (2002) + ETSI EN 300 220-3 V1.1.1 (2000) + EN 60950-1 (2001)

Benincà Luigi, Legal Officer.

Sandrigo, 04/03/2011.



## WARNINGS

This manual has been especially written to be use by qualified fitters.

None of the information provide in this manual can be considered as being of interest for the end users.

Preserve this manual for future needs.

The technician has to furnish all the information related to the step by step function, the manual and the emergency function of the operator, and to deliver the manual to the final user.



Foresee on the supply net an onnipolar switch or selector with distance of the contacts equal or superior to 3 mms.

Verify that of the electrical system there is an awry differential interrupter and overcurrent protection.

Some typologies of installation require the connection of the shutter to be link at a conductive mass of the ground according to the regulations in force.

The electrical installation and the operating logic must comply with the regulations in force.

The leads fed with different voltages must be physically separate, or they must be suitably insulated with additional insulation of at least 1 mm.

The leads must be secured with an additional fixture near the terminals.

During installation, maintenance and repair, interrupt the power supply before opening the lid to access the electrical parts

Check all the connections again before switching on the power.

The unused N.C. inputs must be bridged.

The descriptions and the present illustrations in this manual are not binding. Leaving the essential characteristics of the product unchanged, the manufacturer reserves himself the right to bring any change of technical, constructive or commercial character without undertaking himself to update the present publication.

## TECHNICAL DATA

Control unit power supply	24 Vdc
Power supply	230 Vac 50/60 Hz or 115Vac 50/60Hz according to the version
Output	1 motor 24Vdc
Motor maximum power	220 W
Accessories power supply	24Vdc 1A max.
Protection level	IP40
Operating temp.	-20°C / +70°C
Radio receiver	built in 433,92 MHz configurable (rolling-code or programmable + rolling-code)
Memory capacity	64 rolling-code transmitters

## CONTROL PANEL CP.J4 ESA

### WIRE DIAGRAM

Wire connections shown in Fig. 1 are described hereunder:

Terminals	Function	Description
L/N	Power supply	Input, 230VAC 50/60 Hz (L-Phase/N-Neutral)
L1/N1	Primary Transformer	Connector for the connection of the primary transformer L1: Line N1: Neutral
0V/MOT/ AUX	Secondary Transformer	Connector for the connection of the secondary transformer 0V: Input, 0V – MOT: 30 VAC - AUX: 18 VAC
M1	Motor	Fast connector for the connection of the motor equipped with Encoder
BAR/BAR	SAFETY EDGE	Input, safety edge. A 8.2 Kohm resistance is pre-installed on the terminals. Safety edge of the resistive type, 8K2: connect the edge to the terminals by eliminating the pre-installed resistance, as shown in Figure 3. Safety edge of the mechanical type: connect the edge in series to the resistance, as shown in Figure 3. When the safety edge is activated, the door movement is stopped and reversed for around 3sec.
CLOSE	CLOSE	Input, CLOSE push-button (Normally Open contact).
OPEN	OPEN	Input, OPEN push-button (Normally Open contact). A timer/clock can be connected for openings according to timeframes.
PHOT	Photocell	Input, photocell is activated in the closing phase.
STOP	STOP	STOP button input (N.C. contact)
P.P.	Step by step	STEP BY STEP input ( N.O. contact)
+COM	COMMON	Common for all control inputs.
SHIELD/ANT	antenna	Connection antenna to the built-in receiver SHIELD: Screen / ANT: Signal
+ 24V -	24 Vac/dcs	Accessories power supply 24Vac/1A max. Warning: With the backup battery card CB.24V, the output (without mains) is 24Vdc (polarized). Check devices connection polarity.
BLINK	Flashing	Connection to flashing light 24Vdc 15W max.
SCA	AUX1	Normally open (N.O.), clean contact, which is configurable like SCA (open gate indicator light) through parameter AUX1, second radio channel, courtesy or area light (see Parameter AUX 1).

## RUN SELF-LEARNING AND ANTI-CRUSHING DEVICE SETTING

When operator assembly and wiring is completed, parameters and logic are programmed, self learning allows the operator to learn the stroke and self adjusts amperometric sensor thresholds.

First of all place the opening and closing mechanical stops:

- manually release the door and completely close it. Place the closing mechanical stop in the closed position on the driving carrier and fix it.
- completely open the door. Place the opening mechanical stop in the open position on the driving carrier and fix it.

For further information, please refer to the operator (JM4) manual.

Now the opening and closing positions can be memorized:

Enter menu Auto and press the button < PGM > , PUSH will be displayed.

Press again the button < PGM >: self-learning is beginning: PRG will be displayed, and the control panel completes at least two opening/closing cycles.

When the procedure is completed OK will be displayed.

This procedure can be followed from any position of the gate/door leaf and can be stopped at any moment by pressing keys <+> and <-> at the same time, or through the activation of STOP/PHOTO/PP/CLOSE inputs.

At the end of the self-setting, the PMO and PMC parameters, if previously modified, are shown as default values. If the procedure is not successful, the wording ERR appears. Check that no obstacles or frictions are present.

**IMPORTANT:** The torque value also includes changes in the resistance of the door during movement. The entire stroke is divided in 64 opening points and 64 closing points where the optimal operating torque is read and memorised by the control unit.

## PROGRAMMING

The programming of the various functions of the control unit is carried out using the LCD display on the control unit and setting the desired values in the programming menus described below.

The parameters menu allows you to assign a numerical value to a function, in the same way as a regulating trimmer.

The logic menu allows you to activate or deactivate a function, in the same way as setting a dip-switch.

Other special functions follow the parameters and logic menus and may vary depending on the type of control unit or the software release.

### USE OF PROGRAMMING KEYS

Press <PG> key to gain access to the Main Menu (PAR>>LOG>>RADIO>>...). These keys can be selected by pressing + and - keys.

Select the Main menu with <PG> key to enter the desired Function Menu .

- If <+> is pressed, the Function Menu can be scrolled from top to bottom.
- If <-> is pressed, the Function Menu can be scrolled from bottom to top.
- If <PG> key is pressed, presetting to be modified can be entered.
- The preset values can be modified by using <+> and <-> keys.
- The value is programmed if <PG> key is pressed again. The word "PRG" appears on the display.

NOTES:

Simultaneously pressing <+> and <-> from inside a function menu allows you to return to the previous menu without making any changes.

Hold down the <+> key or the <-> key to accelerate the increase/decrease of the values.

After waiting 30s the control unit quits programming mode and switches off the display.

Pressing <-> with the display turned off means an impulse of P.P.

## PARAMETERS, LOGIC AND SPECIAL FUNCTIONS

In the charts following the single available functions are described in the plant.

PARAMETERS (PRr)			
MENU	FUNCTION	MIN-MAX-(Default)	MEMO
<b>tcA</b>	Automatic closure time. It is enabled only with "TCA"=ON logic. At the end of the preset time, the control unit controls a closure operation.	1-240-(40s)	
<b>tsn</b>	Braking during closure is adjusted. The value is expressed in percentage on the aggregate value of the stroke. In the opening phase, braking is automatically preset by the control unit and no adjustment is required.	1-99-(20%)	
<b>FStS</b>	The opening and closing speed is adjusted.	1-99-(99)	
<b>SLdS</b>	Speed during braking is adjusted.	1-99-(20)	

<i>SA Ir</i>	If it is memorized with the SAIR radio function, the partial opening width is adjusted through the second channel of the transmitter. The TCA automatic closure has no effect on the partial opening. Partial opening is allowed only if the door is completely closed The value is expressed in centimetres.	3-250-(5)	
<i>PNo</i>	Adjustment of amperometric sensor sensitivity during normal speed in opening* 1: maximum sensibility - 99: minimum sensibility	1-99-(10%)	
<i>PNc</i>	Adjustment of amperometric sensor sensitivity during normal speed in closing* 1: maximum sensibility - 99: minimum sensibility	1-99-(10%)	
<i>tLS</i>	It is activated with AUX 1=2 parameter. The activation time of the service light is adjusted.	1-240-(60s)	
<i>SP In</i>	It regulates the tension belt release when the operator arrives to the mechanical stop in closing	0-20-(3)	
<i>AUX 1</i>	It selects the operating mode of the AUX 1 output: 0: Open gate indicator light. The light is off when the door is closed, flashes with moving door and is on with open door. See wire diagram. 1: Second radio channel. The output is controlled by the radio channel of the built-in receiver (see RADIO Menu). 2: Service light. The contact closes for the time preset with TLS parameter. The countdown starts at the inception of the opening operation. 3: Area light. The contact closes in the opening phase and remains closed for the entire TCA time. It opens only with closed door.	0-3-(3)	

**\* ATTENTION: A wrong formulation of these parameters can be dangerous.  
Respect the regulations in force!**

<b>LOGICS (Lógica)</b>			
<b>MENU</b>	<b>FUNCTION</b>	<b>DEAFULT</b>	<b>MEMO</b>
<i>t c A</i>	Enables or disables automatic closing On: automatic closing enabled Off: automatic closing disabled	(OFF)	
<i>ibL</i>	Enables or disables multi-flat function. On: multi-flat function enabled. The step-by-step and pedestrian commands have no effect during the opening phase. Off: multi-flat function disabled.	(OFF)	
<i>ib c A</i>	During the TCA phase, the PP controls are enabled or disabled. On: PP controls are disabled. Off: PP controls are enabled.	(OFF)	
<i>S c L</i>	The rapid closure is enabled or disabled. It can be activated only if TCA:ON On: enabled rapid closure. With open gate, the photocell activation causes the automatic closure after 3 s. If the photocell is activated during the opening phase, the operation is completed and closure starts after 3s Off: disabled rapid closure.	(OFF)	
<i>PP</i>	The operating mode of "P.P. Push button" and of the transmitter are selected. On: Operation : OPEN > CLOSE > OPEN > Off: Operation: OPEN > STOP > CLOSE > STOP >	(OFF)	
<i>P r E</i>	Forewarning flashing light enabled or disabled. On: enabled forewarning flashing light. The flashing light is activated 3 s before the starting of the motor. Off: disabled forewarning flashing light.	(OFF)	

<i>Lt cA</i>	During the TCA time, the blinker is enabled or disabled. On: Enables blinker. Off: Disables blinker.	(OFF)	
<i>c uAr</i>	The code programmable transmitters is enabled or disabled. On: Radio receiver enabled only for rolling-code transmitters. Off: Receiver enabled for rolling-code and programmable code transmitters (self-learning and Dip Switch).	(OFF)	
<i>SoFt</i>	Soft start is enabled or disabled. On: Starting is performed at reduced speed for 2s and then movement is restored to normal speed. Off: Soft start is disabled.	(ON)	
<i>in uA</i>	The movement reversion during opening after the activation of the anti-crash device (amperometric sensor) is enabled or disabled. On: enabled reversion. The amperometric sensor activation causes the movement reversion. Off: disabled reversion. The amperometric sensor activation causes the movement stop.	(OFF)	
<i>SASo</i>	Enables or disables door stop before the opening mechanical stop ON: The control unit stops the door around 5 cm before the mechanical stop. In this way stop is progressive and without vibrations. OFF: The control unit stops the door on the opening mechanical stop	(OFF)	
<i>tSt i</i>	The photocell checks are activated or deactivated. Before the closing operation, the control unit checks the switching of the photocell contact. If the checks are not successful, the door will not close. On: activated check on photocell Off: deactivated check on photocell	(OFF)	
<i>ESA</i>	The "ESA" energy savings function is activated or deactivated. On: Enabled energy savings. After around 10 sec of non-operation, the power supply is cut off from the accessory output and the system switches to stand-by. Off: Disabled energy savings. This is to be used should the accessory power supply output is to be always activated, e.g. if keypads powered at 24VDC or other devices that need to be always powered, are used.	(ON)	
<i>rEn</i>	The remote storage of the radio transmitter codes is enabled or disabled (see par. REMOTE LEARNING). On: Enabled remote storage Off: Disabled remote storage.	(OFF)	

### RADIO (*rAd*)

MENU	FUNCTION
<i>PP</i>	By selecting this function, the receiver is waiting for (Push) a transmitter code to be assigned to the step-by-step function. Press the transmitter key, which is to be assigned to this function. If the code is valid, it will be stored in memory and OK will be displayed. If the code is not valid, the Err message will be displayed.
<i>2ch</i>	By selecting this function, the receiver is waiting for (Push) a transmitter code to be assigned to the second radio channel. Press the transmitter key, which is to be assigned to this function. If the code is valid, it will be stored in memory and OK will be displayed. If the code is not valid, the Err message will be displayed.
<i>SA Ir</i>	When this function is selected, the receiver awaits (Push) a transmitter code to be assigned to the SAIR function (see SAIR parameter). Press the transmitter key, which is to be assigned to this function. If the code is valid, it will be stored in memory and OK will be displayed. If the code is not valid, the Err message will be displayed.



<b>clr</b>	By selecting this function, the receiver is waiting for (Push) a transmitter code to be erased from memory. If the code is valid, it will be stored in memory and OK will be displayed. If the code is not valid, the Err message will be displayed.
<b>rtr</b>	The memory of the receiver is entirely erased. Confirmation for the operation is asked.

### NUMBER OF CYCLES (nPRn)

The number of cycles (open+close) completed by the system is displayed. When the push-button <PG> is pressed once, the first 4 digits are displayed, if the push-button is pressed once more, the last 4 digits are displayed.  
E.g. <PG> 0012 >>> <PG> 3456: 123.456 cycles were performed.

### MAINTENANCE (PRc t)

This function allows to activate the indication of maintenance required after a certain number of operations, preset by the installer.

To activate and select the number of operations, proceed as follows:

Press the <PG> button, OFF is displayed, indicating that the function is disabled (default).

Select one of the numbers shown (from OFF to 100) by using the <+> and <-> keys . The figures express the value of hundreds of cycles (e.g.: the number 50 means 5000 operations).

Press OK to activate the function. The PROG message is displayed.

The warning of maintenance required is indicated to the user through the flashing of the courtesy light LEDs during the opening and closing phases.

### RESET (rE5)

RESET of the control unit. WARNING: Returns the control unit to the default values.

When the <PG> push-button is pressed once, the RES wording begins to flash, if the push-button<PG> is pressed once more, the control unit is reset.

Note: neither the transmitter codes nor the position and stroked of the gate leaf will be erased from the receiver.

### AUTOSET (Aut a)

The self-calibration of the triggering thresholds of the anti-crash device (amperometric sensor), as well as the stroke learning are performed. See paragraph SELF-LEARNING

### PASSWORD (codE)

It allows to type in an access protection code to the programming of the control unit.

A four-character alphanumeric code can be typed in by using the numbers from 0 to 9 and the letters A-B-C-D-E-F.

The default value is 0000 (four zeros) and shows the absence of a protection code.

While typing in the code, this operation can be cancelled at any moment by pressing keys + and – simultaneously. Once the password is typed in, it is possible to act on the control unit by entering and exiting the programming mode for around 10 minutes in order to allow adjustments and tests on functions.

By replacing the 0000 code with any other code, the protection of the control unit is enabled, thus preventing the access to any other menu. If a protection code is to be typed in, proceed as follows:

- select the Code menu and press OK.
- the code 0000 is shown, also in the case a protection code has been previously typed in.
- the value of the flashing character can be changed with keys + and -.
- press OK to confirm the flashing character, then confirm the following one.
- after typing in the 4 characters, a confirmation message “CONF” appears.
- after a few seconds, the code 0000 appears again
- the previously stored protection code must be reconfirmed in order to avoid any accidental typing in.

If the code corresponds to the previous one, a confirmation message “OK” appears.

The control unit automatically exits the programming phase. To gain access to the Menus again, the stored protection code must be typed in.

**IMPORTANT: TAKE NOTE of the protection code and KEEP IT IN A SAFE PLACE for future maintenance operations. To remove the code from a protected control unit, enter the programming mode with the password and reset the code to the 0000 default value.**

**IF YOU LOOSE THE CODE, PLEASE CONTACT THE AUTHORISED SERVICE CENTER FOR THE TOTAL RESET OF THE CONTROL UNIT.**

### ATTENTION:

**After any LOGic change or control panel reset, it is necessary to perform a self-learning procedure (Menu Auto - See Stroke self learning)**

## EMERGENCY BATTERY

An optional accessory to power the control unit is available in the event the mains power supply is cut off. The kit is composed of a battery charger and two 12V rechargeable batteries, fixing brackets, screws and cables. For further information, please refer to instructions supplied with the accessory.

## TRANSMITTER REMOTE LEARNING

If the transmitter code is already stored in the receiver, the remote radio learning can be carried out (without accessing the control unit).

**IMPORTANT:** The procedure should be carried out with gate in the opening phase, during the TCA dwell time.

Proceed as follows:

- 1 Press the hidden key of the transmitter, the code of which has already been stored in memory.
- 2 Within 5 seconds, press the already memorised transmitter key corresponding to the channel to be matched to the new transmitter. The flashing light switches on.
- 3 Within 10 seconds, press the hidden key of the new transmitter.
- 4 Within 5 seconds, press the key of the new transmitter to be matched to the channel selected at item 2. The flashing light switches off.
- 5 The receiver stores the new transmitter code and exits from the programming mode immediately.

## ERROR MESSAGES

Some messages that are displayed in the event of malfunctions are shown hereunder:

<i>Err</i>	Error, radiotransmitter self-adjustment or self-learning	If the error occurs during self-learning, check the STOP/PHOTO/PP/CLOSE inputs or whether frictions occur during the door leaf stroke. If the error occurs during self-learning of the radio-transmitters, this means that the memory of the receiver is no longer able to receive other transmitters or the transmitter is not compatible.
<i>Err 1</i>	Error, motor	Check connections to the motor
<i>Err 2</i>	Error, photocells	Check connections to photocells
<i>Err 3</i>	Error, encoder	Check connections to the encoder
<i>AMP</i>	Triggering of the amperometric sensor	An obstacle or a point of friction has caused the triggering of the amperometric sensor. Remove the obstacle or check the door stroke. Act on the PMO/PMC parameter, if required.
<i>Thrn</i>	Triggering of the thermal switch	The control unit has switched the system to a rest status due to an excessive number of consecutive operations. If a sufficient cooling time has elapsed, the control unit is reset to normal operation. In the negative, a fault in the motor might have occurred, which requires the replacing of the motor.

## DIAGNOSTICS

In the event of malfunctions, by pressing key + or - the status of all inputs (limit switches, control and safety) can be displayed. One segment of the display is linked to each input. In the event of failure it switches on according to the following scheme.

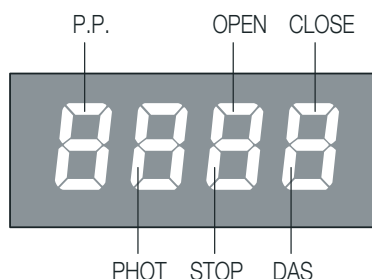

N.C. inputs are represented by the vertical segments. N.O. inputs are represented by the horizontal segments.

## WASTE DISPOSAL

If the product must be dismantled, it must be disposed according to regulations in force regarding the differentiated waste disposal and the recycling of components (metals, plastics, electric cables, etc.). For this operation it is advisable to call your installer or a specialised company.