



Cellcom*Prime*

Advanced GSM Intercom

**Powered
by Vodafone**

- Calls your home phone and mobiles on roll-over when visitor presses call button.
- Never miss a visitor with mobile calling.
- Works with any standard contract or Pre-Pay GSM Micro SIM card.
- Comes with optional Vodafone™ 12 month contract SIM, unlimited calls and texts for £7.50/month + VAT* (terms and conditions apply, zone 1 Europe only).
- Free home owner app to trigger gates, set up auto opening and closing times, create new access codes, receive notifications on entry, etc.
- Free installer app for remote programming and diagnostics.

Cellcomprime

A d v a n c e d G S M I n t e r c o m

Hello to all our customers and readers, and welcome to 2018. This year we have brought a few enhancements to the award winning Cellcom Prime.

In 2017 you told us you loved the apps, the new time clock features and keypad integration to the main GSM board. This year we have added a few more tricks to keep you excited.

First off, we designed a card reader PCB which would slave off the keypad module. This means our panel can now have a keypad AND a card reader. Not just any old reader though, in classic AES style, our reader can also be programmed by App and users will see this App update come out Q1 2018.

This required an update to the main board software, and both the keypad hardware and software.

Adding a slave card or tag reader got us thinking about adding slave devices. We then thought, well, why add one slave, when we could add more? Or how about up to 10? Yes, you guessed it. The latest range of AES Prime GSM intercoms hitting the streets in 2018 will have the ability to add up to a total of 10 keypads or card readers or a mix of both, all connected to the one modem. This move brings AES firmly into small building access control and was a move designed to save customers money on multiple SIM card connections when one will do.

Customers will see the established "GSM-5XX" part numbers change to the next release "PRIME-6XX".

The second huge innovation being released in 2018 is 4G connectivity. We have seen some networks switch off 2G (At&T USA, Vodafone, Telstra and Optus Australia). We have also received more and more press releases from networks in Europe announcing a near future switch off of 2G networks, and in other cases, slightly covert re-forming of 2G spectrum to 4G service, meaning that it has been getting harder and harder to achieve good 2G connections in certain areas.

We hope you enjoy our imminent new releases and we thank you once again for your support in 2018. Thank you for reading.

Managing Director, Advanced Electronic Solutions Global Ltd



Cellcomprime

Advanced GSM Intercom



Set automatic gate open & close times.



Do-not-disturb watershed time.



User history log to your phone.



Illuminated call button and keypad.



Add keypad codes by App.



Issue time restricted codes.



High gain antenna as standard!

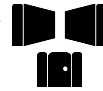

2x Relays

Home Owner /User App Screens

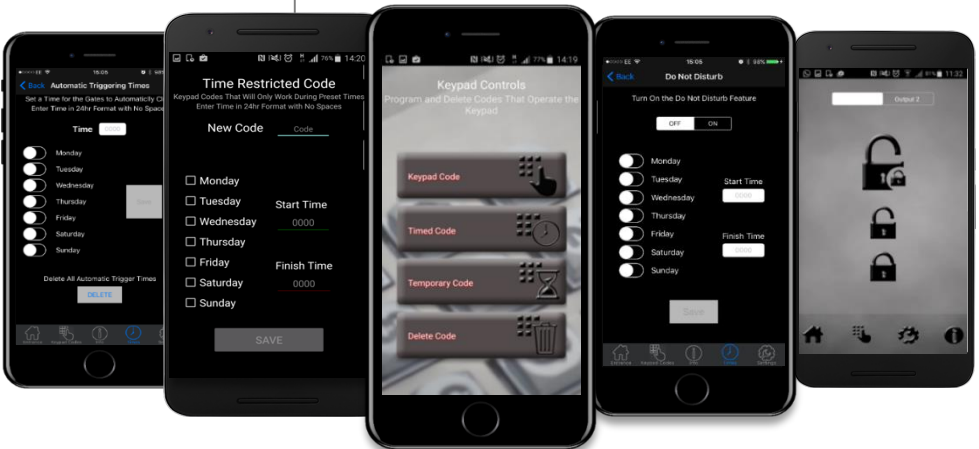

Cellcomprime

Advanced GSM Intercom

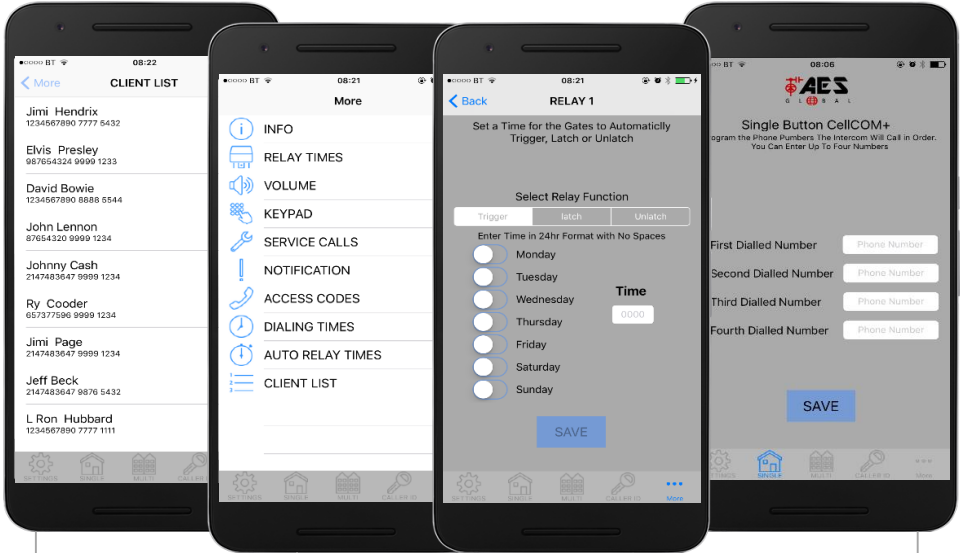

Create a list of all your installs for later editing or diagnostics

Complete menu of all parameters for editing by app

Program auto opening and closing times

Program phone numbers easily!

Technical Details			
Dial Out Numbers	4	Relays	2
Permanent Codes	200	Relay Type	N/C and N/O
Time Restricted Codes	20	Relay Load	2 amps, 24v ac max
Temporary Codes	30	Power Consumption	300mA on dial out, 2amp peak demand
Automatic Trigger Events per Week	40	Modem Models	2G quad band, 3G EU, 3G USA, 4G Europe, 4G USA, 4G AUS/NZ
Caller ID Numbers	100		
Time Restricted Caller ID Numbers	20	Power Supply	12-24v dc (24v dc adaptor included)

Cellcomprime

Advanced GSM Intercom

Imperial Panel

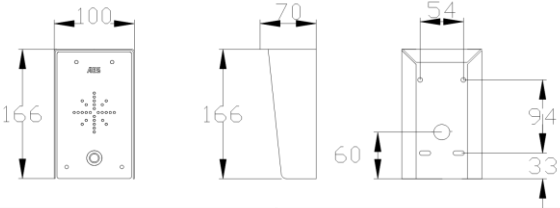
		
<p>Ultra stylish all black panel with textured powder coated aluminium hood and gloss black acrylic facia trim over a tough metal back plate. Complete with modern white illuminated push button.</p>	<p>PRIME6-IMP 2G</p>	<p>Europe *limited connectivity</p>
	<p>PRIME6-IMP/3GE 2G/3G</p>	<p>Europe</p>
	<p>PRIME6-IMP/4GE 2G/3G/4G</p>	<p>Europe</p>
	<p>PRIME6-IMP/4GA 3G+4G</p>	<p>USA</p>
	<p>PRIME6-IMP/4GSA 3G+4G</p>	<p>Australia & NZ</p>

Imperial Panel with Keypad

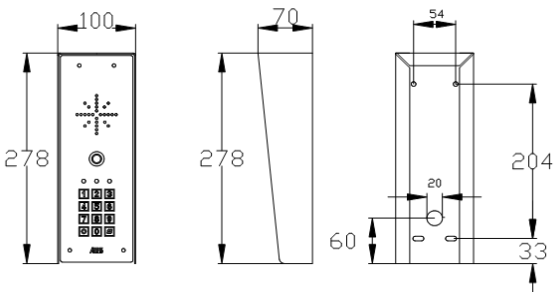
		
<p>Ultra stylish all black panel with textured powder coated aluminium hood and gloss black acrylic facia trim over a tough metal back plate. Complete with modern white illuminated buttons.</p>	<p>PRIME6-IMPK 2G</p>	<p>Europe *limited connectivity</p>
	<p>PRIME6-IMPK/3GE 2G/3G</p>	<p>Europe</p>
	<p>PRIME6-IMPK/4GE 2G/3G/4G</p>	<p>Europe</p>
	<p>PRIME6-IMPK/4GA 3G+4G</p>	<p>USA</p>
	<p>PRIME6-IMPK/4GSA 3G+4G</p>	<p>Australia & NZ</p>

Cellcomprime

Advanced GSM Intercom

Architectural Panel

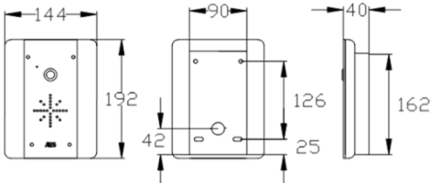
				
<p>Stylish curved architectural model. Constructed from BS316 marine grade stainless steel and finished with gloss black acrylic trim. Modern blue backlighting.</p>	<table border="1"> <tr> <td>PRIME6-AB</td> <td>2G</td> <td>Europe *limited connectivity</td> </tr> </table>	PRIME6-AB	2G	Europe *limited connectivity
PRIME6-AB	2G	Europe *limited connectivity		
	<table border="1"> <tr> <td>PRIME6-AB/3GE</td> <td>2G/3G</td> <td>Europe</td> </tr> </table>	PRIME6-AB/3GE	2G/3G	Europe
PRIME6-AB/3GE	2G/3G	Europe		
	<table border="1"> <tr> <td>PRIME6-AB/4GE</td> <td>2G/3G/4G</td> <td>Europe</td> </tr> </table>	PRIME6-AB/4GE	2G/3G/4G	Europe
PRIME6-AB/4GE	2G/3G/4G	Europe		
	<table border="1"> <tr> <td>PRIME6-AB/4GA</td> <td>3G+4G</td> <td>USA</td> </tr> </table>	PRIME6-AB/4GA	3G+4G	USA
PRIME6-AB/4GA	3G+4G	USA		
	<table border="1"> <tr> <td>PRIME6-AB/4GSA</td> <td>3G+4G</td> <td>Australia & NZ</td> </tr> </table>	PRIME6-AB/4GSA	3G+4G	Australia & NZ
PRIME6-AB/4GSA	3G+4G	Australia & NZ		

Architectural Panel with Keypad

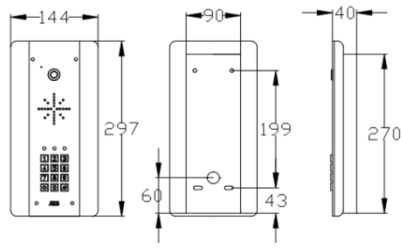
				
<p>Stylish curved architectural model. Constructed from BS316 marine grade stainless steel and finished with gloss black acrylic trim. Modern blue backlighting with integrated keypad.</p>	<table border="1"> <tr> <td>PRIME6-ABK</td> <td>2G</td> <td>Europe *limited connectivity</td> </tr> </table>	PRIME6-ABK	2G	Europe *limited connectivity
PRIME6-ABK	2G	Europe *limited connectivity		
	<table border="1"> <tr> <td>PRIME6-ABK/3GE</td> <td>2G/3G</td> <td>Europe</td> </tr> </table>	PRIME6-ABK/3GE	2G/3G	Europe
PRIME6-ABK/3GE	2G/3G	Europe		
	<table border="1"> <tr> <td>PRIME6-ABK/4GE</td> <td>2G/3G/4G</td> <td>Europe</td> </tr> </table>	PRIME6-ABK/4GE	2G/3G/4G	Europe
PRIME6-ABK/4GE	2G/3G/4G	Europe		
	<table border="1"> <tr> <td>PRIME6-ABK/4GA</td> <td>3G+4G</td> <td>USA</td> </tr> </table>	PRIME6-ABK/4GA	3G+4G	USA
PRIME6-ABK/4GA	3G+4G	USA		
	<table border="1"> <tr> <td>PRIME6-ABK/4GSA</td> <td>3G+4G</td> <td>Australia & NZ</td> </tr> </table>	PRIME6-ABK/4GSA	3G+4G	Australia & NZ
PRIME6-ABK/4GSA	3G+4G	Australia & NZ		

Cellcomprime

Advanced GSM Intercom

Architectural Panel

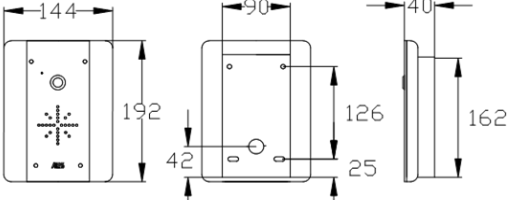
		
<p>Stylish curved architectural model in an attractive and rugged all brushed BS316 marine grade stainless steel with modern cool white back lighting illumination.</p>	<p>PRIME6-AS 2G</p>	<p>Europe *limited connectivity</p>
	<p>PRIME6-AS/3GE 2G/3G</p>	<p>Europe</p>
	<p>PRIME6-AS/4GE 2G/3G/4G</p>	<p>Europe NEW</p>
	<p>PRIME6-AS/4GA 3G+4G</p>	<p>USA NEW</p>
	<p>PRIME6-AS/4GSA 3G+4G</p>	<p>Australia & NZ NEW</p>

Architectural Panel with Keypad

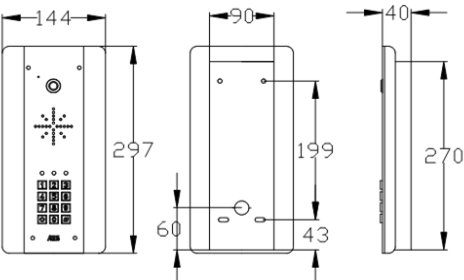
		
<p>Curved architectural model in an attractive and rugged all brushed BS316 marine grade stainless steel with modern cool white back lighting illumination and integrated keypad.</p>	<p>PRIME6-ASK 2G</p>	<p>Europe *limited connectivity</p>
	<p>PRIME6-ASK/3GE 2G/3G</p>	<p>Europe</p>
	<p>PRIME6-ASK/4GE 2G/3G/4G</p>	<p>Europe NEW</p>
	<p>PRIME6-ASK/4GA 3G+4G</p>	<p>USA NEW</p>
	<p>PRIME6-ASK/4GSA 3G+4G</p>	<p>Australia & NZ NEW</p>

Cellcomprime

Advanced GSM Intercom

Industrial Panel

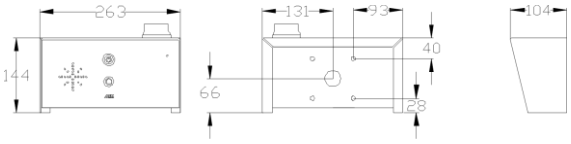
		
<p>Industrial version for pedestal mount, vehicle entrances, trucks and loud industrial applications. BS316 marine grade stainless steel construction with gloss black face trim.</p>	<p>PRIME6-IMP-PED 2G</p>	<p>Europe *limited connectivity</p>
	<p>PRIME6-MP-PED/3GE 2G/3G</p>	<p>Europe</p>
	<p>PRIME6-IMP-PED/4GE 2G/3G/4G</p>	<p>Europe NEW</p>
	<p>PRIME6-IMP-PED/4GA 3G+4G</p>	<p>USA NEW</p>
	<p>PRIME6-IMP-PED/4GSA 3G+4G</p>	<p>Australia & NZ NEW</p>

Industrial Panel with Keypad

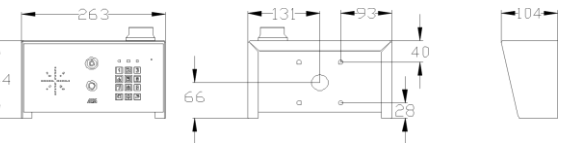
		
<p>Industrial version with keypad for pedestal mount, vehicle entrances, trucks and loud industrial applications. BS316 marine grade stainless steel construction with gloss black face trim.</p>	<p>PRIME6-IMP-PED 2G</p>	<p>Europe *limited connectivity</p>
	<p>PRIME6-IMP-PED/3GE 2G/3G</p>	<p>Europe</p>
	<p>PRIME6-IMP-PED/4GE 2G/3G/4G</p>	<p>Europe NEW</p>
	<p>PRIME6-IMP-PED/4GA 3G+4G</p>	<p>USA NEW</p>
	<p>PRIME6-IMP-PED/4GSA 3G+4G</p>	<p>Australia & NZ NEW</p>