

COPYRIGHT © Hangzhou EZVIZ Software Co., Ltd. ALL RIGHTS RESERVED.

Any and all information, including, among others, wordings, pictures, graphs are the properties of Hangzhou EZVIZ Software Co., Ltd. (hereinafter referred to as “EZVIZ”). This user manual (hereinafter referred to as “the Manual”) cannot be reproduced, changed, translated, or distributed, partially or wholly, by any means, without the prior written permission of EZVIZ. Unless otherwise stipulated, EZVIZ does not make any warranties, guarantees or representations, express or implied, regarding to the Manual.

About this Manual

The Manual includes instructions for using and managing the product. Pictures, charts, images and all other information hereinafter are for description and explanation only. The information contained in the Manual is subject to change, without notice, due to firmware updates or other reasons. Please find the latest version in the EZVIZ™ website (<http://www.ezviz.com>).

Revision Record

New release – January, 2022

Trademarks Acknowledgement

EZVIZ™, ™, and other EZVIZ's trademarks and logos are the properties of EZVIZ in various jurisdictions. Other trademarks and logos mentioned below are the properties of their respective owners.

Legal Disclaimer

TO THE MAXIMUM EXTENT PERMITTED BY APPLICABLE LAW, THE PRODUCT DESCRIBED, WITH ITS HARDWARE, SOFTWARE AND FIRMWARE, IS PROVIDED “AS IS”, WITH ALL FAULTS AND ERRORS, AND EZVIZ MAKES NO WARRANTIES, EXPRESS OR IMPLIED, INCLUDING WITHOUT LIMITATION, MERCHANTABILITY, SATISFACTORY QUALITY, FITNESS FOR A PARTICULAR PURPOSE, AND NON-INFRINGEMENT OF THIRD PARTY. IN NO EVENT WILL EZVIZ, ITS DIRECTORS, OFFICERS, EMPLOYEES, OR AGENTS BE LIABLE TO YOU FOR ANY SPECIAL, CONSEQUENTIAL, INCIDENTAL, OR INDIRECT DAMAGES, INCLUDING, AMONG OTHERS, DAMAGES FOR LOSS OF BUSINESS PROFITS, BUSINESS INTERRUPTION, OR LOSS OF DATA OR DOCUMENTATION, IN CONNECTION WITH THE USE OF THIS PRODUCT, EVEN IF EZVIZ HAS BEEN ADVISED OF THE POSSIBILITY OF SUCH DAMAGES.

TO THE MAXIMUM EXTENT PERMITTED BY APPLICABLE LAW, IN NO EVENT SHALL EZVIZ'S TOTAL LIABILITY FOR ALL DAMAGES EXCEED THE ORIGINAL PURCHASE PRICE OF THE PRODUCT.

EZVIZ DOES NOT UNDERTAKE ANY LIABILITY FOR PERSONAL INJURY OR PROPERTY DAMAGE AS THE RESULT OF PRODUCT INTERRUPTION OR SERVICE TERMINATION CAUSED BY: A) IMPROPER INSTALLATION OR USAGE OTHER THAN AS REQUESTED; B) THE PROTECTION OF NATIONAL OR PUBLIC INTERESTS; C) FORCE MAJEURE; D) YOURSELF OR THE THIRD PARTY, INCLUDING WITHOUT LIMITATION, USING ANY THIRD PARTY'S PRODUCTS, SOFTWARE, APPLICATIONS, AND AMONG OTHERS.

REGARDING TO THE PRODUCT WITH INTERNET ACCESS, THE USE OF PRODUCT SHALL BE WHOLLY AT YOUR OWN RISKS. EZVIZ SHALL NOT TAKE ANY RESPONSIBILITIES FOR ABNORMAL OPERATION, PRIVACY LEAKAGE OR OTHER DAMAGES RESULTING FROM CYBER ATTACK, HACKER ATTACK, VIRUS INSPECTION, OR OTHER INTERNET SECURITY RISKS; HOWEVER, EZVIZ WILL PROVIDE TIMELY TECHNICAL SUPPORT IF REQUIRED. SURVEILLANCE LAWS AND DATA PROTECTION LAWS VARY BY JURISDICTION. PLEASE CHECK ALL RELEVANT LAWS IN YOUR JURISDICTION BEFORE USING THIS PRODUCT IN ORDER TO ENSURE THAT YOUR USE CONFORMS TO THE APPLICABLE LAW. EZVIZ SHALL NOT BE LIABLE IN THE EVENT THAT THIS PRODUCT IS USED WITH ILLEGITIMATE PURPOSES.

IN THE EVENT OF ANY CONFLICTS BETWEEN THE ABOVE AND THE APPLICABLE LAW, THE LATTER PREVAILS.

Table of Contents

Overview	1
1. Package Contents	1
2. Basics	1
Setup	2
1. Power on the Camera	2
2. Get the EZVIZ App	2
3. Add the camera to EZVIZ	3
Camera Installation	3
1. Installation Location.....	3
2. Install Micro SD Card (Optional)	4
3. Installation Steps	4
View Your Device	6
1. Live View.....	6
2. Settings	7
EZVIZ Connect.....	8
1. Use Amazon Alexa.....	8
2. Use Google Assistant	9
FAQ	9
Initiatives on the Use of Video Products	10
Appendix	11
1. Rechargeable Lithium ion Battery	11
2. INFORMATION FOR PRIVATE HOUSEHOLDS	11

Overview

1. Package Contents



Camera (x1)



Drilling Template(x1)



USB Cable (x1)



Screw Kit(x1)



Quick Installation Guide(x1)



Regulatory Information(x2)



Quick Start Guide(x1)

2. Basics

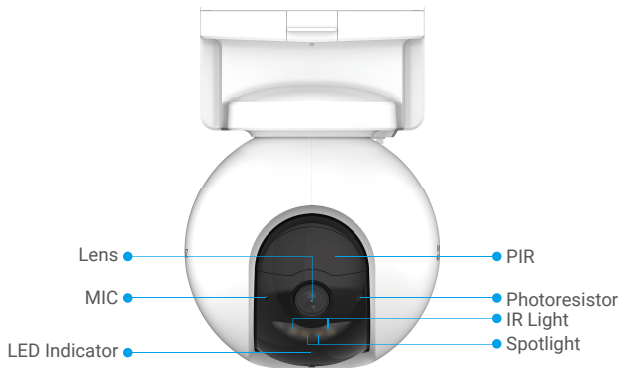

Name	Description
LED Indicator	● ● Slow-flashing Red: Network exception.
	● ● ● ● Fast-flashing Red: Camera exception.
	▬ Solid Blue: Camera starting up or being live viewed in the EZVIZ app.
	● ● Slow-flashing Blue: Camera working properly.
	● ● ● ● Fast-flashing Blue: Camera ready for Wi-Fi connection.
	▬ Solid Green: Camera fully charged.
	● ● Slow-flashing Green: Charging.

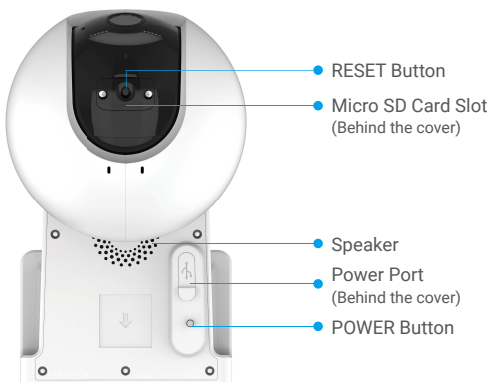

Name	Description
RESET Button	Press and hold for about 4s to restart and set all parameters to default.
Micro SD Card (sold separately)	Initialize the card in the EZVIZ app before using it. Recommended compatibility: Class 10, maximum space 256GB.
POWER Button	• Power on: Press and hold for 2s in shut-down state. • Power off: Press and hold for 4s to power off the camera.
Power Port	For charging the camera.

Setup

1. Power on the Camera

In the shutdown state, press and hold the POWER button for 2s to power on. If the camera is out of battery, connect it to power outlet with the power adapter for charging(5V 2A).

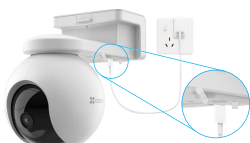

Charging with power adapter



Charging with solar panel

- Both of the power adapter (5V 2A) and solar panel need to be purchased separately.
- Remove the camera from the wall before charging.
- Please do not charge the camera when the temperature exceeds 45 degrees or below 0 degrees.
- It is not allowed to charge the camera with power adapter outdoors.
- When charging, the camera will be automatically turned on.

2. Get the EZVIZ App

- Connect your mobile phone to Wi-Fi using your 2.4GHz network
- Download and install the EZVIZ app by searching for "EZVIZ" in the App Store or Google Play™.
- Launch the app and register an EZVIZ user account.

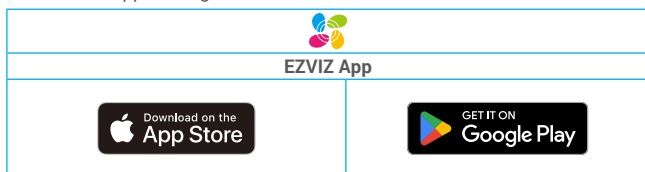

- i** If you have already used the app, please make sure that it is the latest version. To find out if an update is available, go to the app store and search for "EZVIZ".

3. Add the camera to EZVIZ

1. Log in to your EZVIZ app account.
2. On the Home screen, tap "+" on the upper-right corner to go to the Scan QR Code interface.
3. Scan the QR code on the Quick Start Guide cover or on the body of the camera.

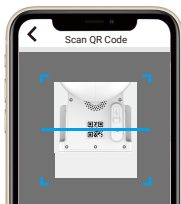

4. Follow the EZVIZ app wizard to finish network configuration of the camera.

Camera Installation

1. Installation Location

Choose a location with a clear, unblocked field of view and with a good wireless signal to the camera. Please keep the following tips in mind.

- Make sure the wall is strong enough to withstand three times the weight of the camera.
- Recommended installation height: 10.0 ft (3m);
- Detection distance range: 6.5-32.8 ft (2-10m).
- Make sure that side-to-side traffic crosses camera's field of view. The camera's motion sensor is much more sensitive to side-to-side movement across its field of view than to movement directly toward or away from the camera.

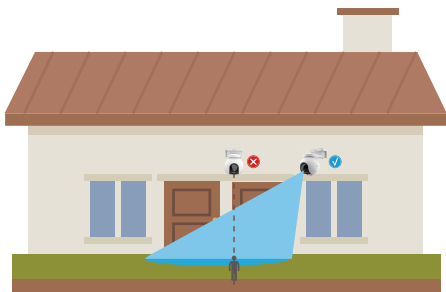

- i** Limited by PIR detection technology, the camera may fail to detect motion when environment temperature is close to human body temperature or someone approaches the PIR sensor vertically.

It is recommended to set detection sensitivity on the EZVIZ app when selecting location. Thus you can verify if motion can be detected in the camera's placement and adjust the sensitivity based on the size and distance of detected object.

Important Notes on Reducing Too Much Alarms:

- Do not install the camera under strong light conditions, including sunshine, bright lamp lights, etc.
- Do not place the camera near any outlets, including the air conditioner vents, humidifier outlets, the heat transfer vents of projectors, etc.
- Do not install the camera at places with strong wind.
- Do not install the camera in front of a mirror.
- Keep the camera at least 1 meter away from any wireless devices, including Wi-Fi routers and phones in order to avoid wireless interference.

2. Install Micro SD Card (Optional)

- Remove the cover on the camera.
- Insert a Micro SD card (sold separately) into the card slot as shown in the figure below.
- Place the cover back on.



 After installing the Micro SD card, you should initialize the card in the EZVIZ app before using it.

- In the EZVIZ app, tap the **Record List** in the Device Settings interface to check the SD card status.
- If the memory card status displays as **Uninitialized**, tap to initialize it.

 The status will then change to **Normal** and it can store videos.

3. Installation Steps

The camera can be wall mounted and ceiling mounted.

Ceiling/Wall Mount

1. Please separate the mounting base and the camera first.

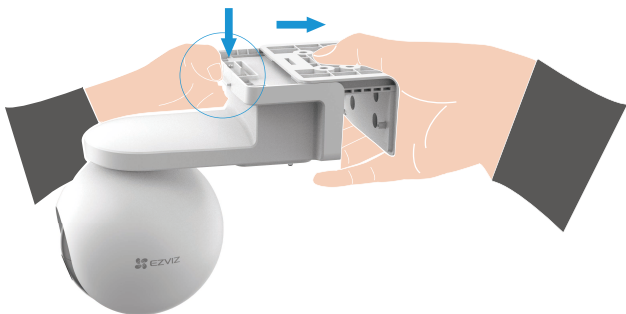

2. Remove the protective film from the lens.
3. Drill template onto a clean and flat surface.
4. (For cement wall only) Drill screw holes according to the template, and insert

the anchors.

5. Use screws to fix the mounting base according to the template.

6. Mount the camera to the mounting base.

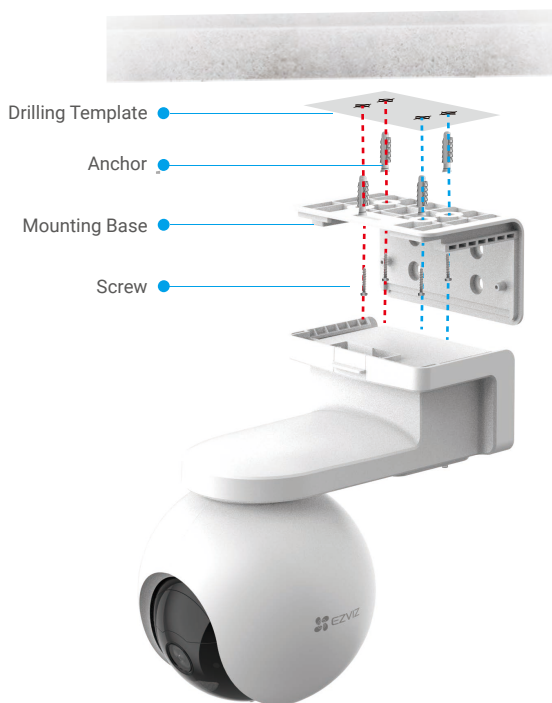

Fig. 1 Ceiling Mount

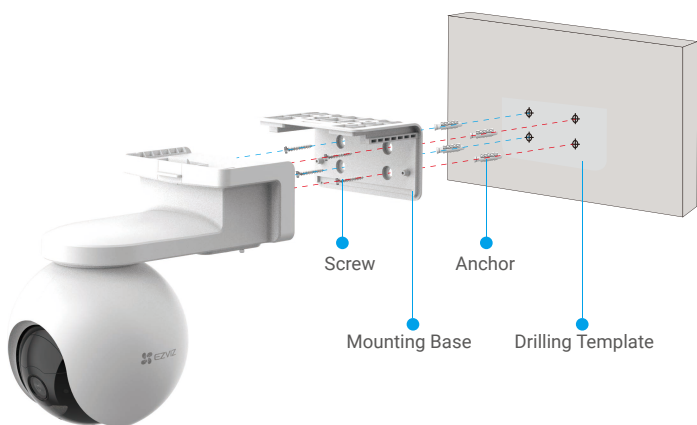

Fig. 2 Wall Mount

View Your Device

i The app interface may be different due to version update, and the interface of the app you installed on your phone shall prevail.

1. Live View

When you launch the EZVIZ app, the device page displays are shown below. You can view and listen to a live feed, take snapshots, record videos, and choose video definition as needed.

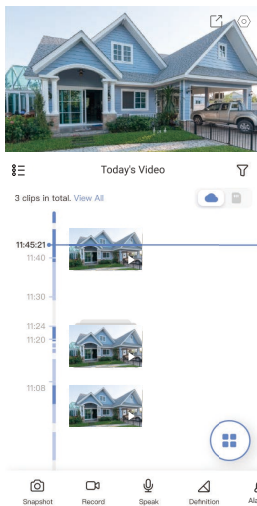

Icon	Description
	Share. Share your device.
	Settings. View or change the device settings.
	Snapshot. Take a snapshot.
	Record. Manually start/stop recording.
	Definition. Select video resolution from Full HD, Ultra HD or Hi-Def.
	Pan/Tilt/Zoom. Rotate the camera to get broader field of view.
	Talk. Tap the icon, and then follow the on-screen instructions to talk to or listen to people in front of the camera.
	360° Picture. Tap to generate a 360 degree view picture.
	Alarm. Sound or flash to deter intruders.
	Multi-screen Live. Tap to select window layouts.

i Swipe left and right across the screen to see more icons.

2. Settings

Parameter	Description
Working Mode	<ul style="list-style-type: none">• Record Mode: The camera will keep recording. Please plug the camera in.• Performance Mode: One video clip is longer but saves less power.• Power Saving Mode: One video clip is shorter and saves more power.• Super Power-saving: Sleep Mode is on. Active live view can wake up the camera.• Configure Working Mode: Customize the working mode in different periods.
Intelligent Detection	<p>You can select a detection type and set detection sensitivity and detection zones here.</p> <p>Detection Types:</p> <ul style="list-style-type: none">• PIR Infrared Detection: Device will send alerts when capturing heat energy of animal or human.• Human Shape Detection: When it is enabled, device will send out an alarm when human body activities are detected.<ul style="list-style-type: none">• Detection Sensitivity Settings: You can set and test the detection sensitivity here.• Detection Zone: You can draw motion detection area by clicking, linear sliding and linear closed sliding.
Notification	<p>For Device-side:</p> <ul style="list-style-type: none">• Audible Notification: You can set your notification sound in different states like mute, intensive, soft, and even custom sound. You can also customize the voice prompt in different periods.• Light Notification: When enabled, camera lights will be flashing when detection is triggered. <p>For App-side:</p> <ul style="list-style-type: none">• Message Notification: When it is disabled, you will receive events in Library but will not push notification.
Audio	When disabled, both live view and recorded videos will not have audio.
Image	<p>You can select different shooting modes here.</p> <ul style="list-style-type: none">• Image Styles:<ul style="list-style-type: none">• Original: Default image style.• Soft: Lower color saturation.• Vivid: Higher color saturation.• Night Vision Mode:<ul style="list-style-type: none">• Color Night Vision: Warm light, can be used as night and the image is colorful.• Black/White Night Vision: IR Light, of high invisibility and the image is black and white. <p>• OSD: When enabled, OSD with the device name will be displayed on all videos captured by the camera.</p>
Light	<p>When disabled, the camera indicator will be off.</p> <p>❶ Exception: The camera indicator will still be on when the camera is exceptional.</p>
Battery	You can see the battery remaining capacity here.
Cloud Storage	You can subscribe and manage the cloud storage.
Record List	You can see micro SD card or eMMC memory card capacity, used space and free space here, and also you can enable or disable cloud storage services here.
Security Settings	If enabled, images captured by the camera can only be available after you enter a password, and you can also change the encryption password here.
Network	You can also check the Wi-Fi signal strength.
Device Information	<p>You can see the device information here, and choose a space where you want to place the device.</p> <ul style="list-style-type: none">• Time Zone: You can select time zone as needed here.• Time Format: You can select date format as needed here.• User Guide: You can read user guide of the camera here.
Share the Device	You can enter an email address or phone number to invite and grant device permissions to a family member or guest.
Delete Device	Tap to delete the camera from EZVIZ cloud. After you have deleted the camera, videos stored in the cloud will not be deleted. Once you add the camera again, the videos can still be viewed.

EZVIZ Connect

1. Use Amazon Alexa

These instructions will enable you to control your EZVIZ devices with Amazon Alexa. If you run into any difficulties during the process, please refer to **Troubleshooting**.

Before you start, make sure that:

1. EZVIZ devices are connected to the EZVIZ app.
2. In the EZVIZ app, turn off the "Video Encryption" and turn on the "Audio" in the Device Settings page.
3. You have an Alexa-enabled device (i.e Echo Spot, Echo-Show, All-new Echo-Show, Fire TV (all generations), Fire TV stick (second generation only), or Fire TV Edition smart TVs).
4. The Amazon Alexa app is already installed on your smart device, and you have created an account.

To Control EZVIZ devices with Amazon Alexa:

1. Open the Alexa app and select "Skills and Games" from the menu.
2. On the Skills and Games screen, search for "EZVIZ", and you will find "EZVIZ" skills.
3. Select your EZVIZ device's skill, then tap **ENABLE TO USE**.
4. Enter your EZVIZ username and password, and tap **Sign in**.
5. Tap the **Authorize** button to authorize Alexa to access your EZVIZ account, so that Alexa can control your EZVIZ devices.
6. You will see "EZVIZ has been successfully linked", then tap **DISCOVER DEVICES** to allow Alexa to discover all your EZVIZ devices.
7. Go back to Alexa app menu and select "Devices", and under devices you will see all your EZVIZ devices.

Voice Command

Discover a new smart device via the "Smart Home" menu in the Alexa app or the Alexa Voice Control function.

Once the device is found, you can control it with your voice. Speak simple commands to Alexa.

-  Your device's name for example: "show xxxx camera," can be changed in the EZVIZ app. Each time you change the name of the device, you will need to discover the device again to update the name.

Troubleshooting

What should I do if Alexa fails to discover my device?

Check if there are any Internet connecting problems.

Try to restart the smart device and re-discover the device on Alexa.

Why the device's status is "Offline" on Alexa?

Your device might have been disconnected from the network. Restart the smart device and re-discover on Alexa.

Check if your router is connected to the Internet and try again.

-  For details about countries where Amazon Alexa is available, see Amazon Alexa's official website.

2. Use Google Assistant

With the Google Assistant, you can activate your EZVIZ device and watch live by speaking Google Assistant voice commands.

The following devices and apps are required:

1. A functional EZVIZ app.
2. In the EZVIZ app, turn off the "Video Encryption" and turn on the "Audio" in the Device Settings page.
3. A TV with functional Chromecast connecting to it.
4. The Google Assistant app on your phone.

To get started, follow the steps below:

1. Set up the EZVIZ device and make sure it works properly on the app.
2. Download the Google Home app from the App Store or Google Play Store™ and log into your Google account.
3. On the Myhome screen, tap "+" on the upper-left corner, and select "Set up device" from the menu list to go to the Set up interface.
4. Tap **Works with Google**, and search for "EZVIZ", where you will find "EZVIZ" skills.
5. Enter your EZVIZ username and password, and tap **Sign in**.
6. Tap the **Authorize** button to authorize Google to access your EZVIZ account, so that Google can control your EZVIZ devices.
7. Tap **Return to app**.
8. Follow the above steps to complete the authorization. When synchronization is completed, EZVIZ service will be listed under your list of services. To see a list of compatible devices under your EZVIZ account, tap on the EZVIZ service icon.
9. Now try some commands. Use the name of the camera that you created when you set up the system.

Users can manage devices as a single entity or in a group. Adding devices to a room allows users to control a group of devices at the same time using one command.

See the link for more information:

<https://support.google.com/googlehome/answer/7029485?co=GENIE.Platform%3DAndroid&hl=en>

FAQ

Q: If the camera is offline on the App, will the video recording continue?

A: If the camera is powered on but disconnected from the Internet, then local recording will continue but cloud recording will stop. If the camera is powered off, both video recordings will stop.

Q: Why the alarm is triggered when nobody in the image?

A: Try to set the alarm sensitivity lower. Please notice that vehicle and animals are also the trigger source.

Q: Live view or playback failed.

A: Make sure that your network is well connected. Watching live videos needs a good bandwidth. You can refresh the video, or change a network and try again.

 For additional information about the device, please refer to www.ezviz.com/eu.

Initiatives on the Use of Video Products

Thank you for choosing EZVIZ products.

Technology affects every aspect of our life. As a high-tech company, we are increasingly aware of the role technology plays in improving business efficiency and quality of life, but at the same time, the potential harm of its improper usage. For example, video products are capable of recording real, complete and clear images. This provides a high value in retrospect and preserving real-time facts. However, it may also result in the infringement of a third party's legitimate rights and interests if improper distribution, use and/or processing of video data takes place. With the philosophy of "Technology for the Good", EZVIZ requests that every end user of video technology and video products shall comply with all the applicable laws and regulations, as well as ethical customs, aiming to jointly create a better community. Please read the following initiatives carefully:

1. Everyone has a reasonable expectation of privacy, and the installation of video products should not be in conflict with this reasonable expectation. Therefore, a warning notice shall be given in a reasonable and effective manner and clarify the monitoring range, when installing video products in public areas. For non-public areas, a third party's rights and interests shall be evaluated when installing video products, including but not limited to, installing video products only after obtaining the consent of the stakeholders, and not installing highly-invisible video products.
2. The purpose of video products is to record real activities within a specific time and space and under specific conditions. Therefore, every user shall first reasonably define his/her own rights in such specific scope, in order to avoid infringing on a third party's portraits, privacy or other legitimate rights.
3. During the use of video products, video image data derived from real scenes will continue to be generated, including a large amount of biological data (such as facial images), and the data could be further applied or reprocessed. Video products themselves could not distinguish good from bad regarding how to use the data based solely on the images captured by the video products. The result of data usage depends on the method and purpose of use of the data controllers. Therefore, data controllers shall not only comply with all the applicable laws and regulations and other normative requirements, but also respect international norms, social morality, good morals, common practices and other non-mandatory requirements, and respect individual privacy, portrait and other rights and interests.
4. The rights, values and other demands of various stakeholders should always be considered when processing video data that is continuously generated by video products. In this regard, product security and data security are extremely crucial. Therefore, every end user and data controller, shall undertake all reasonable and necessary measures to ensure data security and avoid data leakage, improper disclosure and improper use, including but not limited to, setting up access control, selecting a suitable network environment (the Internet or Intranet) where video products are connected, establishing and constantly optimizing network security.
5. Video products have made great contributions to the improvement of social security around the world, and we believe that these products will also play an active role in more aspects of social life. Any abuse of video products in violation of human rights or leading to criminal activities are contrary to the original intent of technological innovation and product development. Therefore, each user shall establish an evaluation and tracking mechanism of their product application to ensure that every product is used in a proper and reasonable manner and with good faith.

Appendix

1. Rechargeable Lithium ion Battery

1. The battery type of the device: Portable battery.
2. The battery of this device is non-removable, which is risky to remove.

Component Parts	Hazardous Ingredients (Chemical Name)	CAS No.	Concentration Ranges	Chemical Formula
Anode	Lithium Manganese Nickel and Cobalt Oxide	346417-97-8	36.3%	$\text{LiNi}_x\text{Co}_y\text{Mn}_{1-x-y}\text{O}_2$
	Polyvinylidene Fluoride(PVDF)	24937-79-9	0.48%	$(\text{C}_2\text{H}_2\text{F}_2)_n$
Cathode	Graphite	7782-42-5	19.38%	C
	Styrene-Butadiene Rubber(SBR)	9003-55-8	0.27%	$\text{C}_{12}\text{H}_{14}$
	sodium carboxymethyl cellulose	9004-32-4	0.22%	$\text{C}_6\text{H}_7\text{O}_2(\text{OH})_2\text{OCH}_2\text{COONa}]_n$
	Nickel	7440-02-0	0.33%	Ni
AL-foil	Aluminium	7429-90-5	2.68%	Al
Cu-foil	Copper	7440-50-8	6.66%	Cu
Electrolyte	Lithium Hexafluorophosphate	21324-40-3	1.79%	LiPF_6
	Ethylene Carbonate(EC)	96-49-1	2.8%	$\text{C}_3\text{H}_4\text{O}_3$
Separator	Polyethylene(PE)	9002-88-4	2%	$(\text{C}_2\text{H}_4)_n$
PET film	Polyethylene terephthalate(PET)	25038-59-9	0.9%	$\text{C}_{10}\text{H}_{12}\text{O}_6$
cell case	Fe	7439-89-6	17%	Fe
others	others	/	9.19%	/

2. INFORMATION FOR PRIVATE HOUSEHOLDS

1. Separate collection of waste equipment: Electrical and electronic equipment that has become waste is referred to as waste equipment. Owners of waste equipment must dispose of it separately from unsorted municipal waste. In particular, waste equipment does not belong in household waste, but in special collection and return systems.

2. Batteries and rechargeable batteries as well as lamps: Owners of waste equipment shall, as a rule, separate waste batteries and rechargeable batteries that are not enclosed in the waste equipment, which can be removed from the waste equipment without being destroyed, from the waste equipment before handing them in at a collection point. This does not apply if waste equipment is prepared for reuse with the participation of a public waste management authority.

3. Options for returning waste equipment: Owners of waste equipment from private households can return it free of charge to the collection points of the public waste management authorities or to the take-back points set up by manufacturers or distributors within the meaning of the Electrical and Electronics Equipment Law. Stores with a sales area of at least 400 m² for electrical and electronic equipment and those grocery stores with a total sales area of at least 800 m² that offer electrical and electronic equipment several times a year or on a permanent basis and make it available in the market are required to take it back. This also applies in the case of distribution using means of distance communication, if the storage and shipping areas for electrical and electronic equipment are at least 400 m² or the total storage and shipping areas are at least 800 m². Distributors shall, in principle, ensure take-back by providing suitable return facilities at a reasonable distance from the respective end user. The possibility of returning waste equipment free of charge exists for distributors who are obliged to take it back, among other things, if a new similar device that essentially fulfills the same functions is delivered to an end user.

4. Privacy Notice: Waste equipment often contains sensitive personal data. This applies in particular to devices of information and telecommunications technology such as computers and smartphones. In your own interest, please note that each end user is responsible for deleting the data on the waste equipment to be disposed of.

5. Meaning of the symbol "crossed-out wheellie bin": The symbol of a crossed-out wheellie bin regularly depicted on electrical and electronic equipment indicates that the respective device is to be collected separately from unsorted municipal waste at the end of its service life.