



Seip
ANTRIEBS-TECHNIK
TS 75

User Guide for the users of the
garage door operators

TM 60

TS 75

TS 100

Please read this user guide before using your operator.
Please read carefully the security advises on the following pages!

Please fill in the serial number of your operator:

(You will find the serial number on your operator)

Factory controlled by:

*(The number describes the person who
made the final controls on this operator)*



English

Important Safety Instructions for the Users

Please read these safety instructions carefully for your own safety and the safety of others!

Your Seip TS door operator is up to the latest safety standards and provides a high level of safety in use. Following the instructions on this page will ensure a long term, trouble free operation.

- **A garage door operator is not a toy - do not allow children to play with it. Keep the hand-transmitter out of reach of children!**

- **Only use the hand-transmitter when you can see the garage door!** If the garage door cannot be seen, you could accidentally close the door whilst a car or person is passing by!

- **When stowing the hand-transmitter please take care that it is not activated accidentally!** Be aware that the buttons could be hit inadvertently and always stow the hand-transmitter with its buttons facing upwards.

- **Whilst entering the garage, store the hand-transmitter safely so that nobody can activate the operator - intentionally or accidentally!** Your garage door may be above your cars roof and you may not be aware that the door has started moving.

- **Always watch the moving door and keep persons away until the garage door is either completely opened or closed!**

- **Do not leave any obstacles in the garage doors operating range! Obstacles such as bicycles left momentarily could be damaged when the operator is activated by another user!**

- **The emergency release must be used with care when the garage door is opened - the door might fall down if the springs are broken!** Before using the emergency release on an opened door you must ensure that neither persons nor obstacles are within the doors moving range.

- **Check the installation regularly for damages.**

- **Check the automatic reversion monthly using a 40 mm high obstacle. Check the function every time adjustments or changes are made to the garage door.**

- **Should problems occur with your remote-control then please contact your dealer. Repairs should only be carried out by an authorised dealer.**

- **The light bulb may be exchanged by taking off the operators' front cover. Please unplug the power cord before taking off the front cover!**

- **The remaining parts of the operator may only be opened by authorised personnel!**

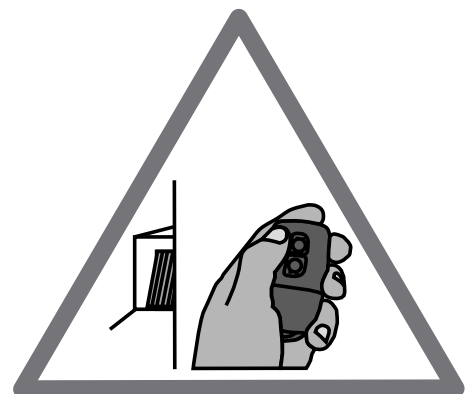

Using the Operator

4-channel MIDI transmitter, 433 MHz
(standard equipment)

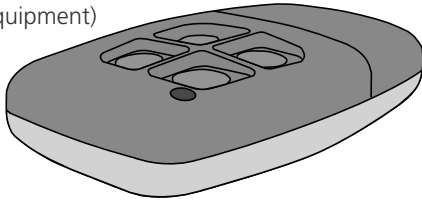

Wall push-button, IP 44
(standard equipment)

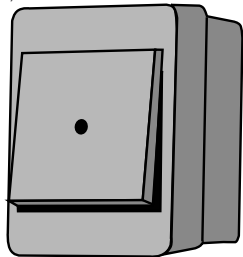

2-channel MINI transmitter, 433 MHz (optional extra)

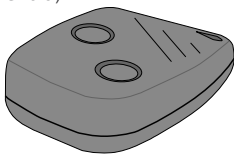

Key switch
(optinal extra)

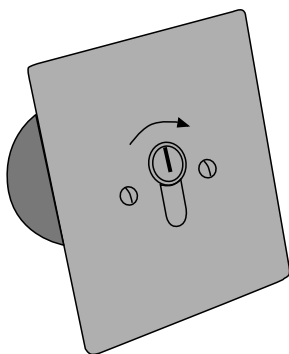

Devices

There are different devices available to activate your operator.

Standard Equipment:

- MIDI hand transmitter (4-channel)
- Wall push button

Optional Extra:

- Key switch
- MINI hand transmitter (2-channel)
- Code Lock
- other devices (for example special entry systems)

The devices may be used alongside each other.

Usage

The operator follows the principle OPEN-STOP-CLOSE. This principle is valid for any device.

Starting from closing position of the door this means:

First impulse: the door **opens**

Second impulse: the door **stops**

Third impulse: the door **closes**

Fourth impulse: the door stops

Fifth impulse: the door opens
and so on.

Usually it will not be necessary to stop the operator during operation - unless you realise there is an unexpected obstacle within the doors range.

Please also refer to the Safety Instructions on page 2.

The operator registers an obstacle by touching it - the garage door hits the obstacle and reverses to set the obstacle free again. Dependant on the make of the garage door slight damages might occur on obstacles - a cars paintwork might become scratched.

With an additional security device like a photocell (optional extra) the operator will stop as soon as an obstacle is recognised by the photocell. Should the door be in the opening position the operator will only close the door once the obstacle has been removed from the photocells range. With such a device contact between the garage door and any obstacle is usually avoided.

Programming the Hand Transmitters

Basics

As a standard the operator is equipped with a 433 MHz AM remote control set. The coding is done via rolling code - the code is changed after each impulse; receiver and transmitter agree completely automatic about the next code to be used. New codes will be chosen out of a pool of billions of possible codes.

Your operator is equipped with our standard remote control set when you hand transmitters looks like the one shown on the right hand side. The 4-channel MIDI transmitter is standard equipment, the 2-channel MINI transmitter is available as an optional.

If your operator is equipped with another remote control set, please refer to the manufacturers instructions for programming.

Programming Transmitter and Receiver

To use a hand transmitter it must first be registered (programmed) by the receiver. Only one hand transmitter button can be used for one receiver.

Registering the first hand transmitter

The first hand transmitter (e.g. no hand transmitter has been registered for the receiver, yet) must be learned directly via the operators' main electronic:

1. Press the LERN/LEARN button on the main electronic for approx. 3 seconds until the operator's light starts blinking and release the LERN/LEARN button.

2. Press the hand transmitter button you want to register to the receiver - the operators' light stops blinking when the transmitters' signal was received. The transmitter is now registered.

Registering additional hand transmitters

When at least one hand transmitter has been registered by the receiver you may program additional hand transmitters from a distance:

1. The garage door must be closed

2. Open the garage door approx. 50 cm and close it again.

3. After the garage door is closed you have got 10 seconds to press the buttons 1+2 simultaneously on the registered hand transmitter - the operator's light then starts blinking.

4. The light will keep blinking for another 10 seconds - during that period of time you must press the button on the new hand transmitter which you want to use with the operator. Once the new transmitter is registered the operator's light stops blinking.

The procedure must be repeated for each new hand transmitter.

Clearing the receivers' memory

Keep the LERN/LEARN button pressed for approx. 15 sec.. The operators' light and the red LED „Diag“ will start blinking after 3 seconds. After another 10 seconds the red LED „DIAG“ will glow constantly. You can then release the LERN/LEARN button.

All previously programmed hand transmitters are now cleared from the receivers' memory.

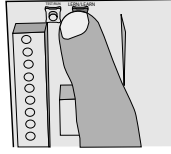
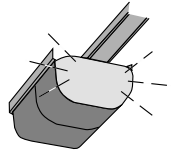
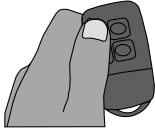
Quick reference: programming the first hand transmitter	
1.) Keep the LERN/LEARN button pressed for approx. 3 sec.	The operators' light will start blinking
	
2.) Press the hand transmitter button you want to use	The operators' light stops blinking - the transmitter was successfully programmed
	

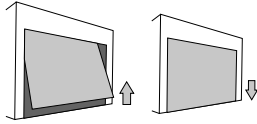
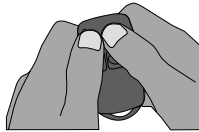
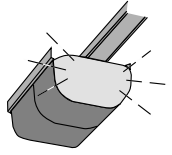
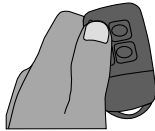
Quick reference: Programming additional hand transmitters from a distance	
<i>Remark: additional hand transmitters can be programmed either like the first transmitter or from a distance as explained below:</i>	
1.) Open the garage door for approx. 50 cm and close it again	After the garage door is closed you have got 10 seconds to proceed to step 2)
	
2.) Press buttons 1+2 simultaneously on any registered transmitter for 3 sec.	The operators' begins blinking - release the hand transmitters' buttons
	
3.) Take the new hand transmitter and press the button you want to use shortly	The operators' light stops blinking - the hand transmitter was successfully programmed
	

Additional Information

4-channel MIDI transmitter,
433 MHz, rolling code

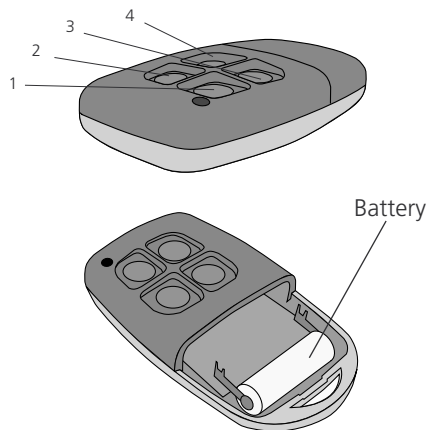

Usable types of batteries: A23, 23A, 23L, EL12, VR 22 and MN 21
Voltage: 12V
Used batteries must be disposed of according to national laws!

2-channel MINI transmitter (optional extra),
433 MHz, rolling code

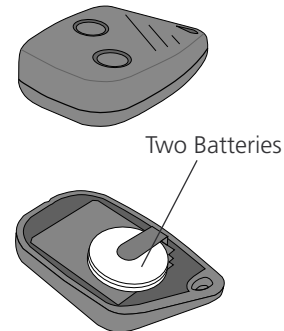

Two batteries, type CR1616 or DL1616 are required.
Voltage: 2* 3V (=6V)
Used batteries must be disposed of according to national laws!

Criteria influencing the range

The TS operators are equipped with a high quality remote control set as a standard!

Nevertheless the remote control is the part of the operator which might be influenced by circumstances in the surroundings of the garage. With our standard remote control you might reach a range of more than 100 meters. In areas with high disturbances the range will still be approx. 50 meters.

The range might be influenced by:

- old batteries in the hand transmitter - if you should experience a problem with the range, please change the batteries first. The lower the batteries run the lower the range will be.

- Building materials of the garage
In a garage made of concrete and steel you might reach a lower range than in an ordinary garage build of stone. The more steel was used for the walls the shorter the range of your remote-control.

Remote-control activity in the area
Radio and television transmitters close to your garage might reduce the range.

Older baby-phones
Especially older baby-phones might influence the range of the remote control severely. These devices send strong signals via the houses internal power supply net. These signals also intrude other devices via the wall plug, as eg the operator.

It is extremely unlikely that the range will drop to an unacceptable distance. If, however, problems should occur we will like to be helpful.

HomeLink® Use with a HomeLink® System

The HomeLink® System is becoming more and more popular in private households. Most frequently it is being used in cars - the HomeLink® module is integrated in the car. It allows the driver to activate the door operator with a push of button which is installed in his car. Once programmed, the driver does not need the hand transmitter to access the garage with his car.

The standard remote control supplied with the TS-series is compatible with HomeLink® systems manufactured by end of year 2002 / beginning of year 2003 (subject to technical alterations).

The procedure how to program the HomeLink® device is described in the car's manual - please refer to those instructions. *(Basic information on programming: you first must register the hand transmitter with the operator. The HomeLink® system will then learn the code from the hand transmitter).*

Please avoid to drop the hand transmitter - parts could be damaged inside the transmitter. That might lead to malfunctions!

Should a problem occur

Most occurring problems are not necessarily caused by the operator but by the garage door.

Your TS-operator is equipped with an automatic force measurement. During the installation the operator memorises how much force it needs to open and close your garage door.

Changes to the door weight caused by the weather (the door might go out of alignment slightly due to hot or cold weather conditions) will not affect the operation of your door operator.

The operator will also adjust itself to the normal and slow changes of your garage doors' performance caused by ageing.

In contrast, rapid changes to the weight of the garage door will be recognised by the operator - the operator will then behave as if it had registered an obstacle. In CLOSING direction this means that the operator stops and reverses into opening direction to release a supposed obstacle.

In OPENING direction it means that the operator will stop and reverse a few centimetres into closing direction to release a supposed obstacle. During the soft-stop period in CLOSING direction the operator will reverse for a few centimetres - the door will always remain open a few centimetres.

Rapid changes normally occur when:

- a spring of your garage door is broken; especially when the springs are covered by protectors you might not recognize the damage
- mechanical damages to the garage door happened (e.g. by hitting the door with a car)
- a new surface was attached to the garage door or the whole door was exchanged (e.g. an increase of the doors' weight)

In all of these cases the garage door needs to be maintained - please contact your dealer.

When the operators' light is blinking

The operator is also equipped with an error system - if an error should occur then the operators' light will start blinking when you try to activate it. The blinking light refers to errors caused by external devices - the following steps only need to be followed if any of the devices mentioned are connected to your operator:

- check all security devices connected to your operator (photocell, security beam or hatch door switch)
- check, that all obstacles are removed from the photo cells' range of observation
- check if there is dirt on photo cell; clean if necessary
- check if the hatch door is closed

If the operators' light is still blinking after checking all devices then please contact your dealer. The dealer will also find it helpful if you counted the number of blinks given by the operators' light - it may give a hint concerning the problem.

In case of a power failure

You can disconnect your garage door from the operator using the emergency release. The emergency release is fitted to your operator in either way shown on the diagrams on the right.

If your garage door is the only entrance to your garage then you can disconnect the operator by using your garage doors lock and handle. Unlock the door and turn the handle - the operator will be disconnected automatically and you can open your door by hand.

If you have got a separate entrance to your garage then you can enter your garage and pull the cord hanging down in front of your garage door. The operator will be disconnected and the door can be opened by hand.

ATTENTION: It might be dangerous disconnecting the operator from an open garage door. If the doors' springs are damaged or the door is not well balanced then it might drop down - there is a high risk of injuries and damages!

If, however, you cannot avoid disconnecting the operator from an open garage door then you must make sure that there is no one within the range of the garage door before using the emergency release!

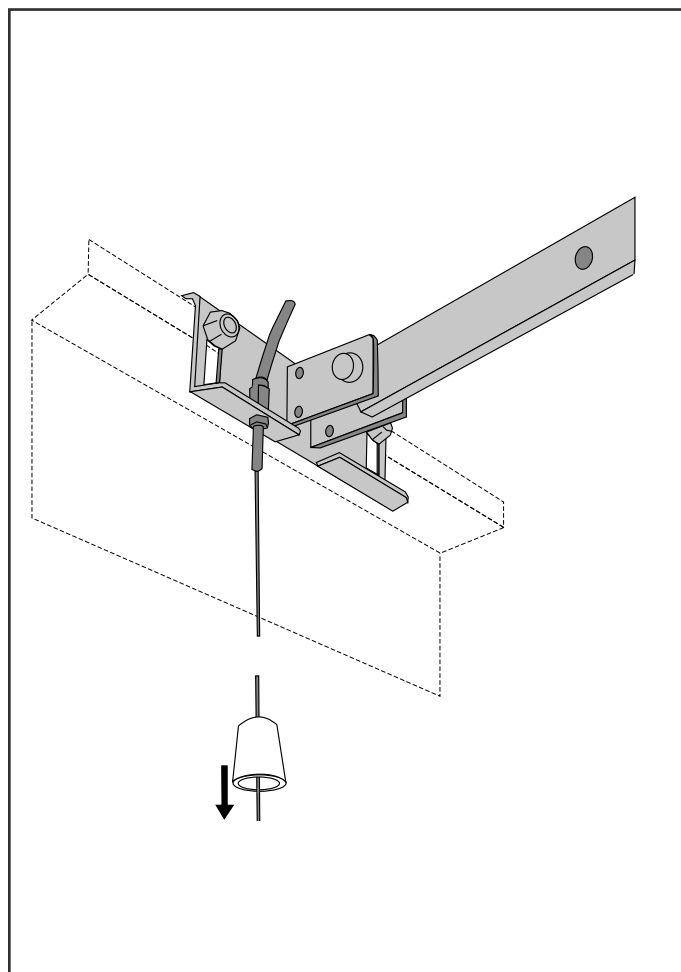
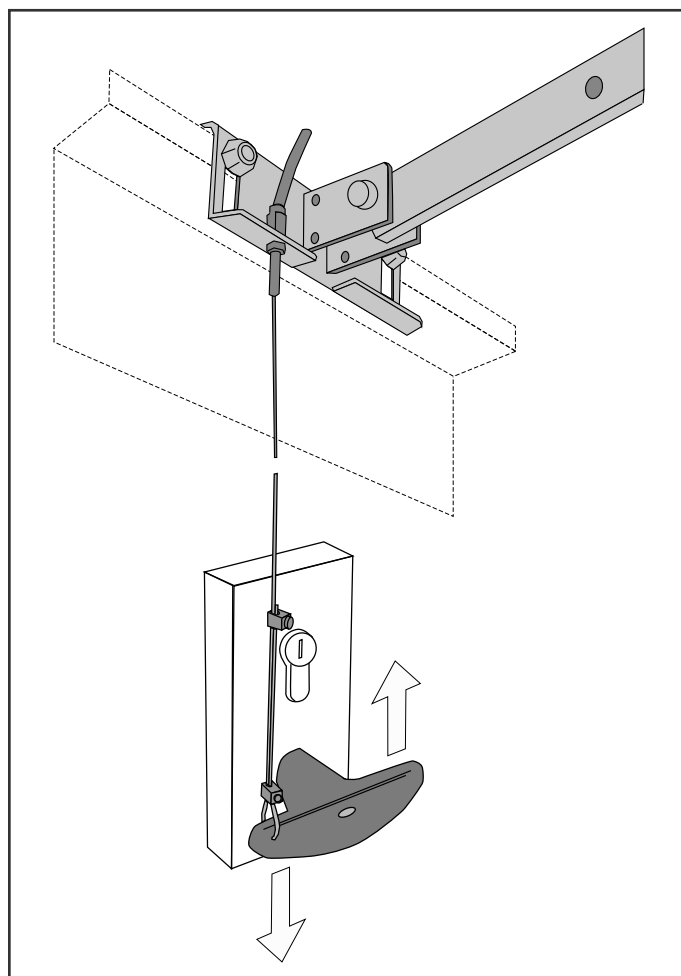

EC Declaration of Conformity
 Low-Voltage Directive 73/23/EEC
 and amendments
 Electro-Magnetical Compatibility 89/336/EEC
 and amendments

Document No. AN-16062003
 Dokument Nr. AN-16062003



EG-Konformitätserklärung
 im Sinne der EG-Richtlinien
 Niederspannungsrichtlinie 73/23/EWG
 mit Änderungen
 Elektromagnetische Verträglichkeit 89/336/EWG
 mit Änderungen

We,
 Wir,

Seip Antriebstechnik GmbH
Grombacher Straße 83, 75045 Walzbachtal-Jöhlingen, Deutschland

hereby declare, that the following products comply to the mentioned EC-regulations.
*erklären hiermit, daß die nachfolgenden genannten Produkte den unten angegebenen
 EG-Richtlinien entsprechen.*

Type of Product / Produktart	Garage Door Operator / Torantrieb
Product Name / Modell	TM 60, TS 75, TS 100, SE 130 TS
Approved according to 89/336/EEC and 73/23/EEC / Geprüft nach 89/336/EWG und 73/23/EWG Referring EC-regulations: / Angewandte harmonisierte Normen:	
Electromagnetic Compatibility / Elektromagnetische Verträglichkeit	EN 61000-3-2:2000 Limits for harmonic current emissions / <i>Grenzwerte für Oberschwingströme</i> EN 61000-3-3:1995 + Corrigendum:1997 + A1:2001 Limitation of voltage changes, voltage fluctuations and flicker in publik low-voltage supply systems / <i>Grenzwerte für Spannungsschwankungen und Flicker</i> EN 61000-6-3:2001 Emission standard for residential, commercial and light-industrial environments / <i>Störaussendung für Wohnbereich, Geschäfts- und Gewerbereiche sowie Kleinbetriebe</i> EN 61000-6-2:2001 Generic standards - Immunity for industrial environments <i>Fachgrundnorm - Störfestigkeit - Industriebereich</i>
Low-Voltage Directive / Niederspannungsrichtlinie	EN 60335-2-95:2001-7 Particular requirements for drives for vertically moving garage doors for residential use / <i>Anforderungen für Antriebe von Garagentoren mit Senkrechtbewegung zur Verwendung im Wohnbereich</i> EN 60335-1:1994 + A1:1996 + A2:2000 + A11:1995 + A12:1996 + A13:1998 + A14:1998 + A15:2000 + A16:2001 Safety of household and similar electrical appliances / <i>Sicherheit elektrischer Geräte für den Hausgebrauch</i>
Safety in Use / Nutzungssicherheit	EN 12453:2000 Safety in use of power operated doors, requirements / <i>Nutzungssicherheit kraftbetätigter Tore, Anforderungen</i> EN 12445:2000 Safety in use of power operated doors, Test methods / <i>Nutzungssicherheit kraftbetätigter Tore, Prüfverfahren</i>

Peter Seip, Geschäftsführer, Walzbachtal-Jöhlingen, 16.06.2003



Grombacher Straße 83
 75045 Walzbachtal-Jöhlingen
 Germany
 www.seip.com

EC Declaration of Conformity
in accordance with the Radio and Telecommunications
Terminal Equipment Act (FTEG) and Directive 1999/5/EC
(R&TTE Directive)

EG-Konformitätserklärung
gemäß dem Gesetz über Funkanlagen und Telekomm
unikationsendeinrichtungen (FTEG) und der Richtlinie
1999/5/EG (R&TTE)

Document No. FU-16062003
Dokument Nr. FU-16062003



We,
Wir,

Seip Antriebstechnik GmbH
Grombacher Straße 83, 75045 Walzbachtal-Jöhlingen, Deutschland

declare that the product
erklären, daß das Produkt

SKR 433

Code B43A023004

Hand Transmitter as remote control for garage door operators
Handsender als Fernbedienung für Garagentorantriebe
(Short Range Device)
(Funkgerät geringer Reichweite (SRD))

complies with the essential requirements of §3 and the other relevant provisions of the FTEG (Article 3 of the R&TTE Directive), when used for its intended purpose.
bei bestimmungsgemäßer Verwendung den grundlegenden Anforderungen des §3 und den übrigen einschlägigen Bestimmungen des FTEG (Artikel 3 der R&TTE) entspricht.

§3(1)1, (Article 3(1)a) does not refer to this type of product.
§3(1)1, Artikel 3(1)a bezieht sich nicht auf diesen Produkttyp, es gibt hierzu keine Norm

Protection requirement concerning electromagnetic compatibility §3(1)(2), (Article 3(1)(b))
Schutzanforderungen in Bezug auf die elektromagnetische Verträglichkeit §3(1)2, Artikel 3(1)(b))

EN 300 220-1/1997
EN 300 683/1997
EMV / EMC Directive 89/336/EEC;92/31/EEC;93/68/EEC

A handwritten signature in black ink that reads 'Peter Seip'.

Peter Seip, Geschäftsführer, Walzbachtal-Jöhlingen, 16.06.2003

Seip
ANTRIEBS | TECHN | K
GmbH

Grombacher Straße 83
75045 Walzbachtal-Jöhlingen
Germany
www.seip.com