

Installation & User Manual
For
703 Four Button
DECT Intercom



Wireless Intercom System

Models AB, ABK, HB, HBK,
Version 2
(2 Relay Version)



Contents

Overview of systemPg 3
Site SurveyPg 3
Mounting the TransmitterPg 3
Power supplyPg 3
Mounting Architectural PanelsPg 4
Mounting Hooded PanelsPg 4
Mounting Flush PanelsPg 4
WiringPg 5
Code Lock Keypad ConnectionsPg 6
Wiring TipsPg 6
Keypad OverviewPg 6
Basic Keypad ProgrammingPg 7
Full Keypad programmingPg 7
Using the KeypadPg 9
The HandsetPg 9
Recoding / Adding a HandsetPg 10
TestingPg 10
Using the Intercom HandsetPg 10
Maintenance of the IntercomPg 11
TroubleshootingPg 11

Overview of System

Please read this entire manual before attempting to install this system.

This system should only be installed by a professional automatic gate installer or access control specialist installer.

It is recommended that the system be range tested on site BEFORE being fully installed.

Site Survey

Before installing this system, you need to be sure that the range of the system will be sufficient.

The transmitter and speech unit can be powered up, call button pressed, and then check that the handset will ring from all areas in which it will be used.

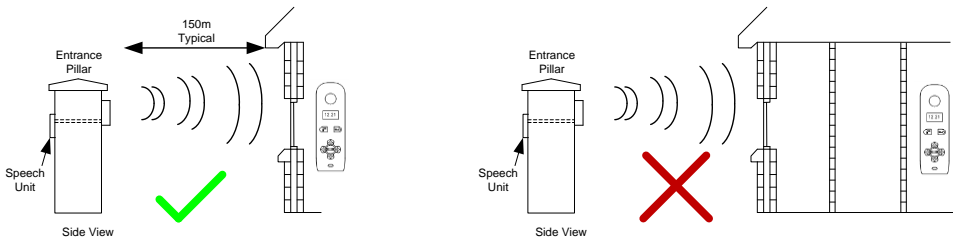

Tip: For longer range installations, locate the handset close to the front of the property, near a window if possible. Concrete walls can reduce the open air range of 350 metres by 30-50% per wall.

Mounting the Transmitter

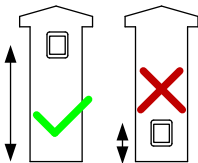

The transmitter should be mounted as high as possible on the gate pillar or wall to maximise range. Mounting close to the ground will reduce range and is also more likely to be further restricted by long wet grass, overhanging shrubs and vehicles.

Power Supply

TIP: Most technical calls received are due to installers using CAT5 or alarm cable to power the unit. Neither are rated to carry enough power (1.2 amp peak). Please use following cable...

Up to 2 metres (6 feet) – Use minimum 0.75mm² (18 gauge)

Up to 4 metres (12 feet) – Use minimum 1mm² (16 gauge)

Up to 8 metres (24 feet) – Use minimum 1.5mm² (14 gauge)



Using insufficient power cable thickness will cause excessive stress on electronic components, and therefore void the manufacturer's warranty.

To avoid such problems, it is recommended (and is good practice) to locate the power supply as close to the transmitter as possible. This avoids power cable noise and interference and enhances the lifetime of the product.

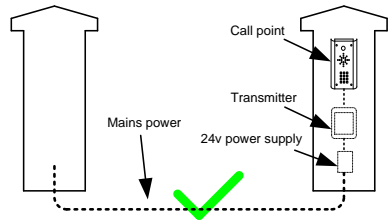
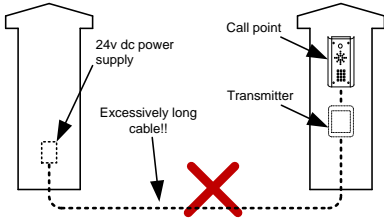

Mounting Architectural Panels

Loosen top 2 screws only

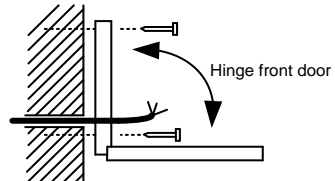
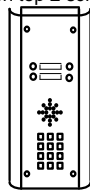

Side View

Mounting Hooded Panels

Loosen top 2 screws only

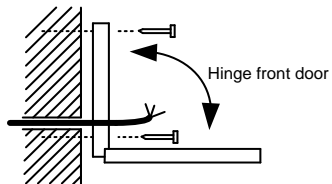
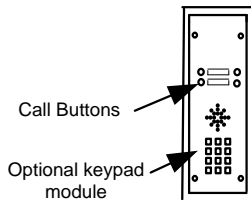

Side View

Wiring

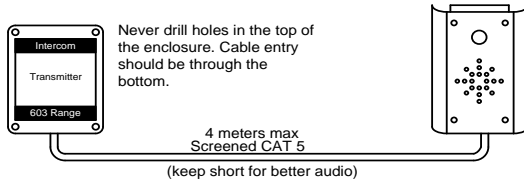

If you have a 2 button panel, you will be wiring call buttons 3 and 8.
For a 4 button panel, the corresponding button locations are 2, 3, 8 and 9.

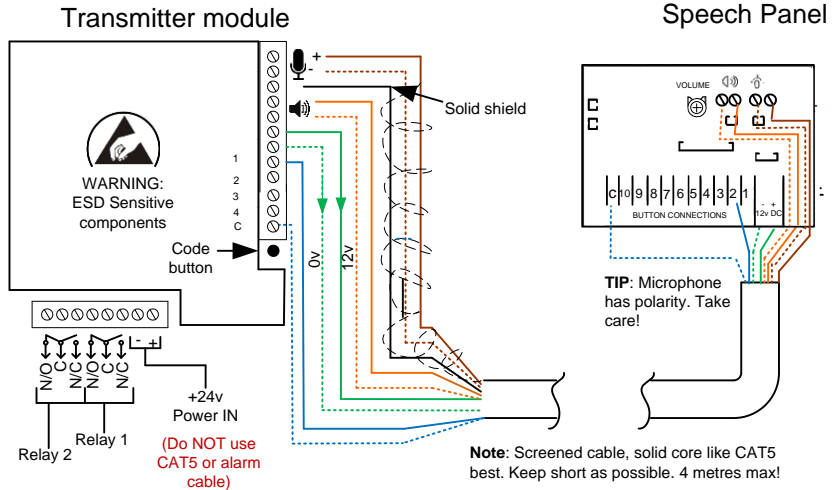

Wiring Call Buttons for 703 multi button versions

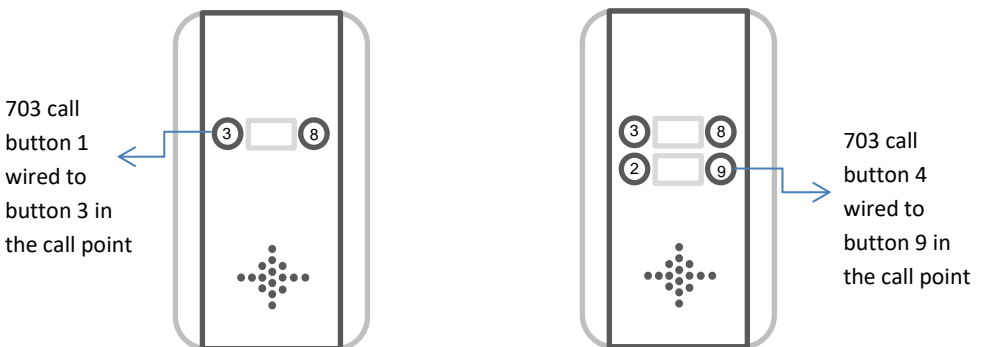

Please note the position of the buttons on the above panel options. For example, if you have a 2 button panel, you will be wiring call buttons 3 and 8. For a 4 button panel, the corresponding button locations are 2, 3, 8 and 9.

Keypad overview

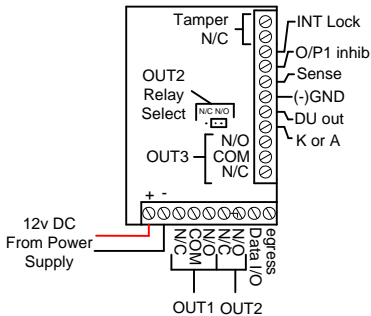

Commonly used connections

Outputs – This keypad has 3 outputs. All can be programmed for momentary and latching operation. For gate systems and AC strike locks, connect a keypad relay (normally open) in **parallel** with the transmitter module relay. For magnetic locks, connect in series with normally closed contact.

Egress – This is for an optional exit button input, connected across this terminal and GND (-).

Advanced connections

INT Lock – Used to operate a door in conjunction with another keypad. 24v dc max voltage, 100mA sink.

O/P1 inhibit – When closed, this disables all codes for relay group 1.

Sense – N/C connected to (-)GND, to be connected to N/C door contact. Can be used to generate door open or tamper alarm.

DU out – switches to (-) ground after the Duress Code is entered. Used to trigger alarm zone, or buzzer to notify guard. 100mA sink, 24VDC.

K or A – Not used.

DATA I/O PORT (Data Communication Bus) The Data I/O port is prepared for setting up a data bus for the connection of the auxiliary reader-keypads and the split-decoder in system expansion

Wiring Tips

TIP: If your system has a keypad, it will need a relay connected to the lock or gate system as well as the transmitter relay.

Connecting DC magnetic lock

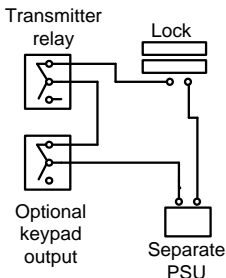

Connecting AC/DC strike lock

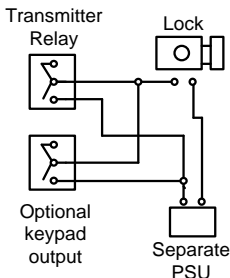

Connecting automatic gates

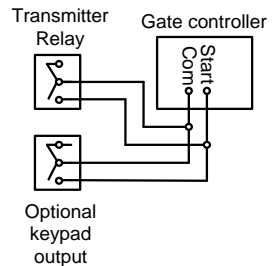

This keypad has 3 outputs. The diagram below shows the LED indicators which indicate programming and relay status information.

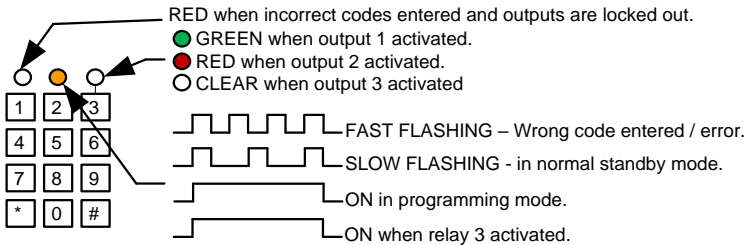

TIP: After power up, as a security precaution, the keypad cannot be programmed for 60 seconds. Once this time elapses, you may begin.

TIP: Flashing amber LED is normal standby mode!

Basic Keypad Programming

Quick start guide

- 1) Enter programming mode (amber LED should be ON)

0	0	0	0	*	*
---	---	---	---	---	---
- 2) Enter a new user code...

1	0	2	0	0	0	?	?	?	?	#
---	---	---	---	---	---	---	---	---	---	---
- 3) Exit programming mode

*	*
---	---
- 4) Enter the new user code to check the relay clicks.

Tip: The engineer code must be the same length as user codes. So if using a 6 digit engineers code, then user codes must also be 6 digits long etc.

Full Keypad programming

Enter programming mode..



The unit is now in programming mode. Amber LED on the keypad should remain permanently on. 0000 is the default programming passcode.

Exit programming mode..



The unit should exit programming mode and the amber LED should start flashing again.

Enter a new ENGINEERS code...

Go into programming mode firstly then enter the following sequence...



Enter or delete new user codes

There are 3 groups of user codes. Group 10 for relay 1, group 20 for relay 2, and group 30 for relay 3. The programming sequence is shown below...

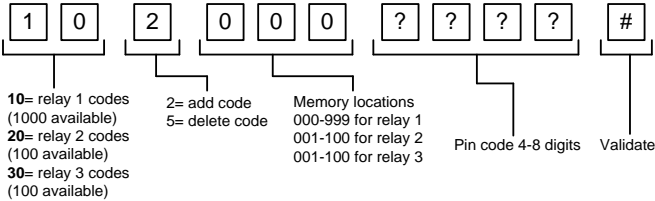

Example: Add user 31 to have access code 5555 operating relay 2...

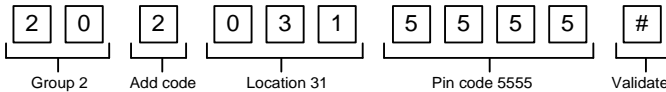

Programming relay output times and modes...

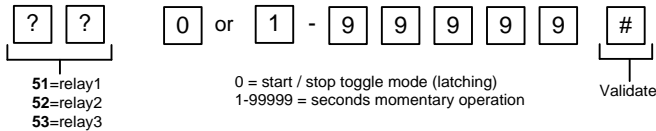

Delete a user code even if you don't know the code...

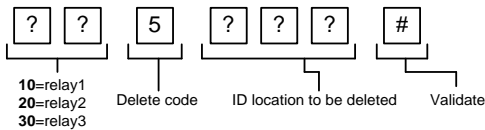

Delete an entire group of codes

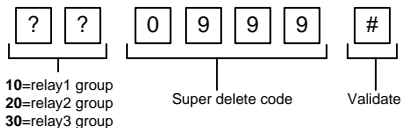

Programming super user codes...

A super user code can activate any of the 3 relays

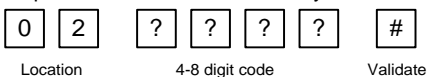

Restoring defaults

When in programming mode, you can enter the following sequence...

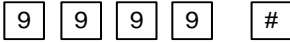

When the master code is forgotten....

- 1) Wire a push button (or replicate with wire link) across the Egress terminal and (-)GND.
- 2) Switch off power for 1 minute.
- 3) Switch ON power.
- 4) during the first 60 seconds, press the EG button once to enable the function.
- 5) Enter the following code..

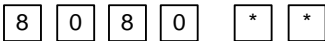

The keypad should now be in programming mode, ready to accept new data.

Using the keypad

Using the standard codes...

Once you have exited out of programming mode, simply enter the user code.

Using super user codes

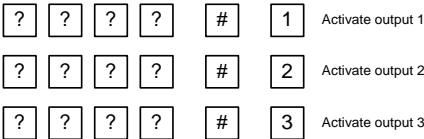

The Handset

The handset should be charged for 8 hours before use. It is recommended to give it at least 1 hour charge before range testing.

Ring Another Handset

Press \triangleright and the unit will display HS1-5 depending on how many handsets are coded. Press ∇ and \triangle to select and then OK to call that handset.

Voicemail

When a call is not answered within 40 seconds, the visitor can leave a message. Once complete, the handset will display the  symbol. The unit can store up to 16 messages.

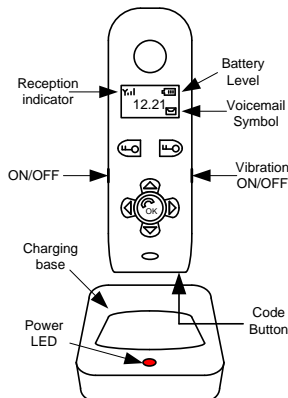

Change Ring Volume

Press \triangle and ∇ to increase and decrease ring volume and press OK to save.

Change Ring Tone

Press \triangleleft and the handset will ring with its currently selected tone.

Press \triangle and ∇ to cycle through available ring tones and press OK to select and save.

To listen to voicemail, press OK to play. If there are more than 1 message, press Δ and ∇ to select the message required and press OK to play. ☒ = Delete (Relay 1). Long press = delete all.

Testing

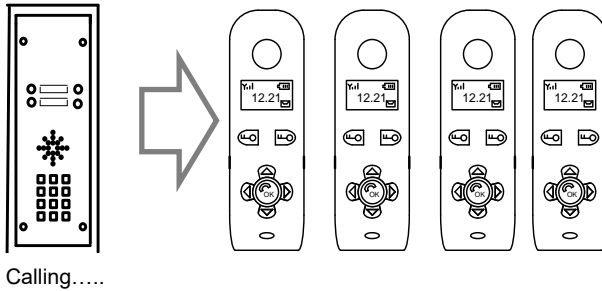

Answer the call on any handset by pressing OK , and check for good 2 way speech. Adjust volume while on a call with up and down arrow buttons on the handset and press the same button again to end the call. The gate/door release button can be pressed at any time, either while on or off a call. The relay on the transmitter should then pulse on for 4 seconds.

Using the intercom Handset

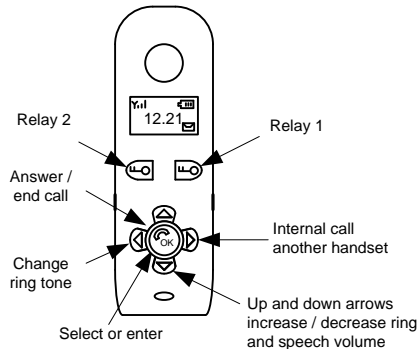

Adjusting Relay time

Press Relay 2 button for 3 seconds, scroll through menu until you see 'ti'. Press OK to select 'ti' and adjust your relay times. Press OK to select your relay time. Press the right arrow end the process. Both relays will have the same relay time.

Adjusting time on Handset

Press OK for more than 2 seconds, and then use up and down arrow keys to set hour. Press OK again to cycle to minutes and adjust. Press OK once more to end the process.

VoiceMail

To turn your voicemail ON, press and hold Relay 2 button for 3 seconds, scroll through the menu until you see 'Re'. Press OK to select 'Re' and adjust your setting to ON or OFF. Press OK to select. Press the right arrow end the process.

Maintenance of the Intercom

The stainless steel can dull or discolour over time in weather conditions or in winter if exposed to road salt. This can be polished with a suitable stainless steel cleaner or re-brushed with an abrasive pad or sand paper, observing the directionality of the grain.. Take care when cleaning the acrylic face. This should be gently wiped with a soft damp cloth to prevent scratching.

Troubleshooting guide

Q. The unit will not ring the handset.

A. Try re-coding the handset and transmitter as per instructions.

- Check push button wiring to the transmitter with multi-meter.

-Check power cable distance from power adaptor to transmitter is less than 4 metres.

Q. The person on the handset can hear interference on the call.

A. Check cable distance between the speech unit and transmitter. Shorten this if possible.

-Check cable used between the speech unit and transmitter is screened CAT5.

-Check that the screen of the CAT5 is connected to ground in the transmitter as per wiring instructions.

Q. Keypad code not operating the gate or door

A. Check if the corresponding relay indicator light comes on. If it does, then the fault is either a power problem with excessive cable run, or wiring. If the relay can be heard clicking, then it is a wiring problem. If a click cannot be heard, then it is likely a power problem. If the light does not activate and the keypad emits an error tone, then the issue is likely a programming error.

Q. My handset will not recode

Try the process again. If it still does not work, delete the code from the transmitter. To delete code, press the code button for 3 seconds and release. Then press it 7 times after which a tone should be heard. Then press another 7 times. Now try re-coding the handset again as per the procedure.

Q. Range problem – Handset works beside the intercom, but not from inside the building

A. Check that the power cable to the transmitter is within guidelines and is heavy enough gauge.

Insufficient power cabling will reduce transmission power! Check that there are not excessive objects blocking the signal, like large dense shrubs, vehicles, foil lined wall insulation etc. Try to achieve line of sight between both devices.

Q. No speech in either direction

A. Check CAT5 wiring between speech panel and transmitter. Disconnect, re-strip cables and re-connect again.

Q. Handset will not charge

A. Try replacing both batteries with equivalent Ni-Mh batteries firstly. It is possible to have a dead cell in a battery which can prevent both batteries from charging.

-Check for contamination or grease on the charging pins at the base of the handset (gently scratch with screwdriver or wire wool).

Q. The unit will not power up / there is a short circuit on the power supply

A. This can be caused by the inbuilt surge protection being short circuited due to a surge, over voltage, or wiring fault. Disconnect all wiring, check, and re-wire again. If the fault still appears, contact your dealer for service.

