

PROFESSIONAL INSTALL ONLY

Do **NOT** give this manual to the end user / home owner

Prime6 6E Module Manual

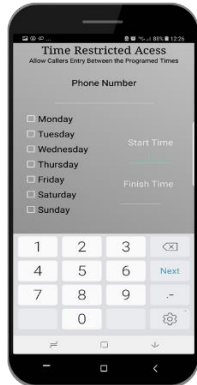
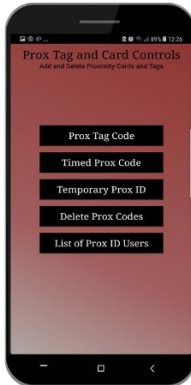
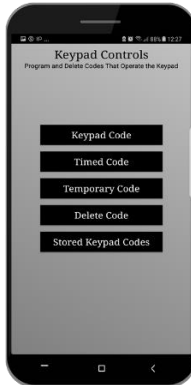
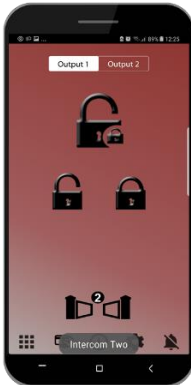
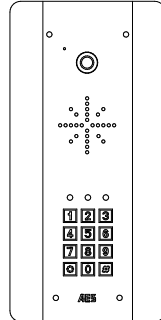
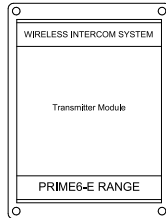
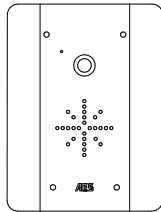

Scan the QR code below to install the INSTALLER App



Contents

Overview of System	Pg 3
Site Survey	Pg 3
SIM card	Pg 3
Power	Pg 3
Installation	Pg 4
Architectural & Hooded panels	Pg 4
Flush Panels	Pg 4
Inserting the SIM card	Pg 4
Call Station and Power Connections	Pg 5
Main External Connections	Pg 5
Connecting of slave devices	Pg 6
Powering Up	Pg 7
Installing Programmers App for first time	Pg 8
Programming a Brand New Install	Pg 9
Programming an Existing Install	Pg 9
Programming	
Check Reception	Pg10
Programming Dial Out Numbers	Pg 11
Program Caller ID Numbers	Pg 12
Programming Additional Features	Pg 13
Volumes	Pg 14
Dial Times & Talking Time	Pg 14
Service Calls	Pg 15
Diagnostic Info	Pg 15-16
Pass Codes	Pg 17
Relay Times	Pg 17
Notifications	Pg 18
Keypad Programming	Pg18-20
Auto Relay Trigger Times	Pg 21
Client List on iphone	Pg 21
Client List on Android	Pg 22
Clock Sync	Pg 22
Daylight Saving	Pg 23
Do Not Disturb	Pg 23
After Hours / Out of Hours	Pg 24
Proximity card & tag programming	Pg 25
Complete List of Parameters	Pg 28
Troubleshooting	Pg 31
Change History	Pg 32

Overview of System

Please read this entire manual before attempting to install this system.

This system should only be installed by a professional automatic gate installer or access control specialist dealer.

It is recommended that the system be set up, configured, commissioned and tested on a workshop bench **before** taken to site for installation.

Site Survey

Before installing this system, you need to be sure that there is good mobile GSM cell coverage in the area it is to be installed. It is recommended that you conduct a site survey, and check reception on the site for a GSM network. If reception is poor in the area, then this system is not recommended.

SIM Card

You will need a SIM card in order to use this system. It should be a regular voice and SMS text SIM card and capable of running on 2G service. Do not use a data only SIM, as this is only for tablets and will not work in the unit.

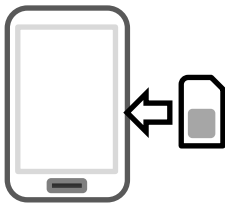

- 1) Ensure the SIM has calling credit, and can make and receive calls on a mobile cell phone.
- 2) Check that the SIM is not locked to a phone and can be used in other devices.
- 3) Check that the SIM does not have a PIN code request.
- 4) Disable voicemail service on the SIM.
- 5) You are now ready to begin programming.

Power

TIP: Most technical calls received are due to installers using CAT5 or alarm cable to power the unit. Neither are rated to carry enough power (2 amp peak). Please use following cable...

- Up to 2 metres (6 feet) – Use minimum 0.5mm² (18 gauge)
- Up to 4 metres (12 feet) – Use minimum 0.75mm² (16 gauge)
- Up to 8 metres (24 feet) – Use minimum 1mm² (14 gauge)

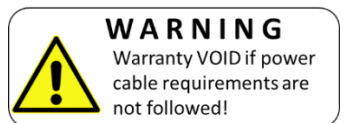

WARNING

Warranty VOID if power cable requirements are not followed!

Using insufficient power cable thickness will cause excessive stress on electronic components, and therefore void the manufacturer's warranty.

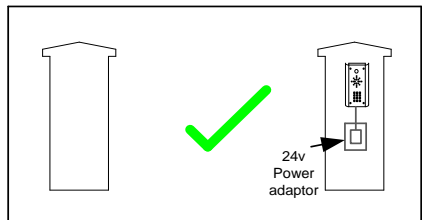
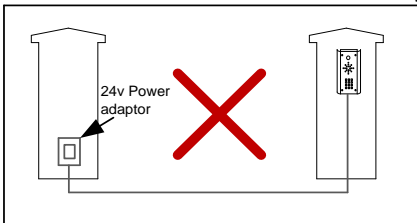

To avoid such problems, it is recommended (and is good practice) to locate the power supply as close to the transmitter as possible. This avoids power cable noise and interference and enhances the lifetime of the product.

Architectural & Hooded Panels

Loosen top 2 screws only

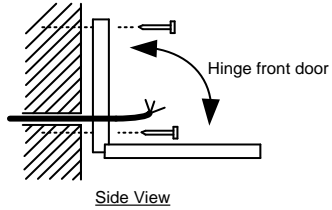
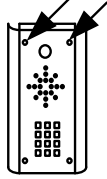

Flush Panels

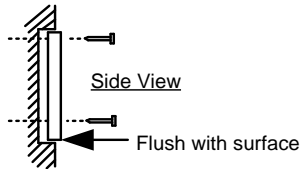
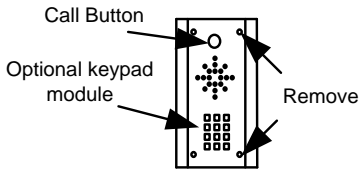

Tip: Use appropriate fixings to ensure the intercom cannot be removed from the wall.

Inserting the SIM card

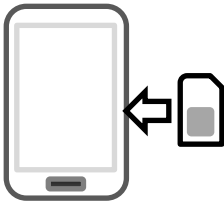

Please ensure the SIM card is a Nano SIM card. Do not use a SIM card for a tablet, as these only support data, and do not support voice and SMS. You simply require a mobile phone type SIM card.

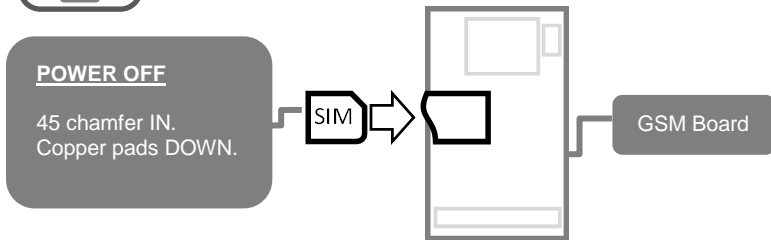

Call Station and Power Connections

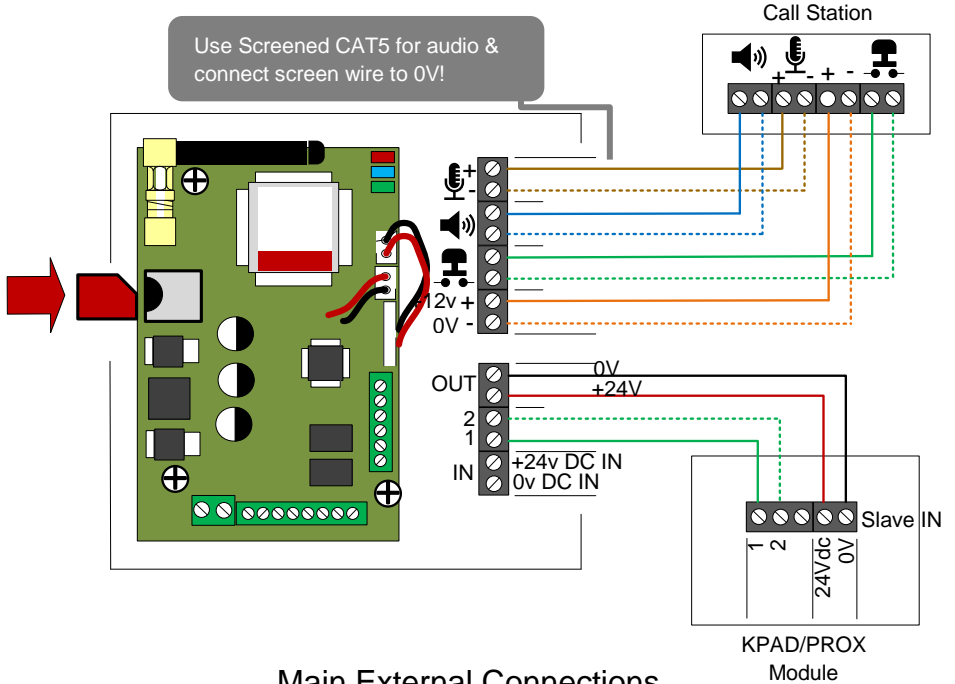

Main External Connections

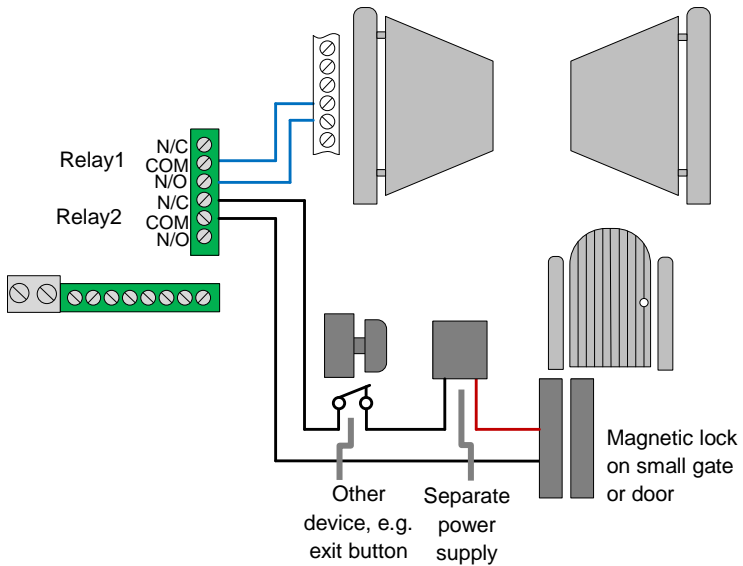

Other External Connections

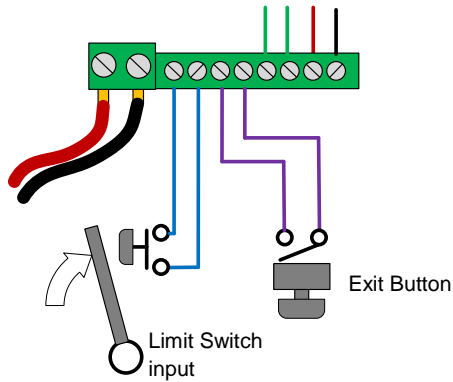

Connecting of Slave Devices

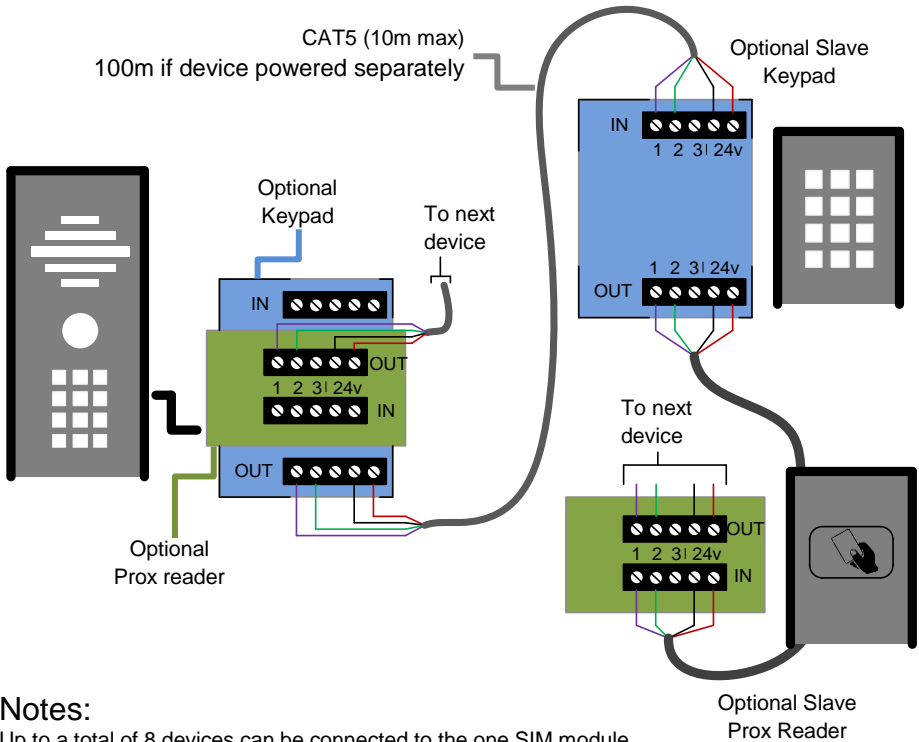

Notes:

- Up to a total of 8 devices can be connected to the one SIM module.
- All keypads will be programmed with the same codes as the main unit.
- All Prox units will store the same Prox cards.
- Powering slave devices locally for longer distances.

Powering Up

Perform a final check of wiring and ensure the antenna is connected before switching on the power. Once the power is switched on, the power LED should illuminate.

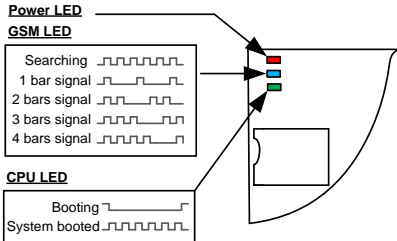

TIPS:

My GSM LED is still searching...

- Check the SIM card is registered and can make a call in a phone.
- Check the SIM card is seated correctly. Power off, clean the contacts on the SIM and the GSM unit, and reinsert the SIM.
- Check power cable distance and thickness.
- Increase antenna height.
- Change network.
- Move antenna away from metal objects & shrubs.
- Fit a high gain antenna.

Installing the Programmer APP for the first time

1. For android or apple devices you can download the AES programming app called “Cellcom Prime Programmer” (or scan QR code below).

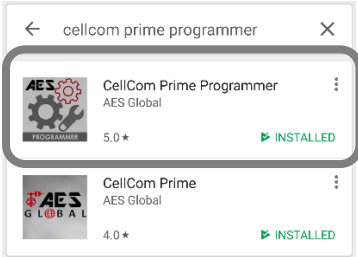

2. Open the app and allow all permissions (Android users).

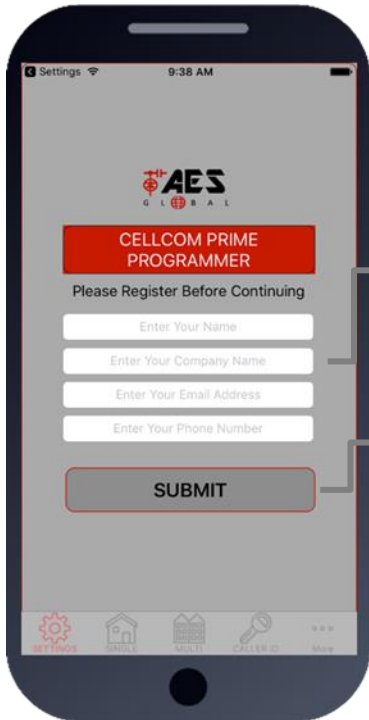

Register your details first time for support registration.

Press Submit and send your details via email client.

Programming a Brand-New Install

Carrier 9:40 AM

AES
GLOBAL

Settings
Enter and Save Client Information. This Can Then Be Accessed and Edited in Your Client List

First Name

Last Name

Phone Number

Engineer Code

Access Code

SAVE

Cancel

Press SETTINGS to reveal the screen shown. This screen will store details for the client.

Enter name or site name for customer.

Enter INTERCOM SIM phone number.

Default Engineer's and user's pass codes. These can be changed later.

Now you are ready to begin programming!

10:12

< More CLIENT LIST

Buddy Holly
01635486764 9999 1234 ⓘ >

John Wayne
16543219780 9999 1234 ⓘ >

Burt Lancaster
186543219780 9999 1234 ⓘ >

Marvin Gaye
07894561230 9999 1234 ⓘ >

Settings Home More CALLER ID More

Programming an EXISTING Install

1.Go to MORE>CLIENT LIST to reveal the screen shown.

2.Press and HOLD to select the desired client.

3.Iphone users press the info symbol. Android users **press and hold** the client, and then press upload to begin programming.

Now you are ready to begin programming!

Programming

Now that you have either entered a new client, or selected an existing client from the client list, you are now ready to begin programming.

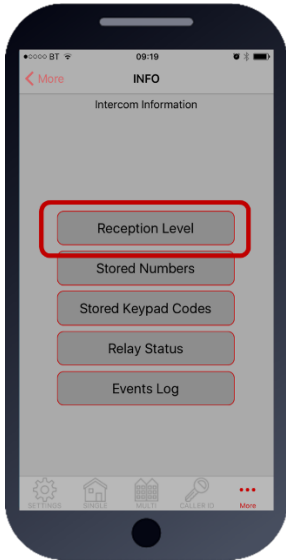

Step 1: Check Reception

Go to MORE>INFO & press the reception check button.

On Android the app will automatically send a SMS string (*20#) to the intercom.

On iPhone, users will be taken to their SMS screen to confirm before sending the string. The intercom should then reply with a signal level between 1 and 31.

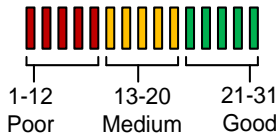

For good performance, signal level on 2G should be at least 13. On 3G products it should be no less than 10.

TIP: If signal is lower than recommended, then take IMMEDIATE action. Change network if possible, or use an optional high gain antenna. Check power cable is within recommended specification. (Poor power cable can lower reception).

Note: SMS string= *20#



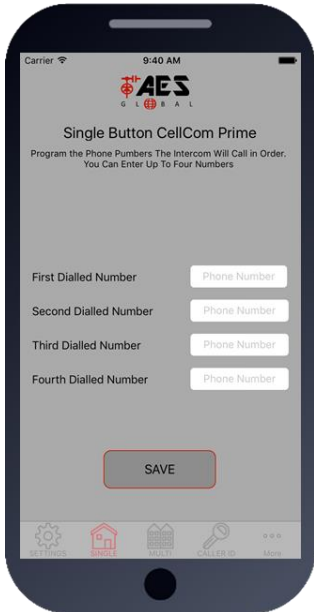

Step2: Programming Numbers for the intercom to call on button press.

1. Press the SINGLE home icon for a 1 button system, or MULTI for a 10 button system.
2. Simply enter cell phone numbers and/or landline phones which the intercom is to call when the call button is pressed. (10 button model please enter button number).
3. Press SAVE. Note: iphone users will be taken to their SMS screen to confirm the SMS string (press send).
4. The intercom should reply with an SMS to your phone showing the SMS string and an OK status.

SMS Programming Format:

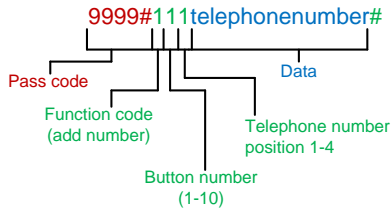

E.g. 9999#111firstnumber#112secondnumber#113thirdnumber#

Programming dial out numbers for multi button versions

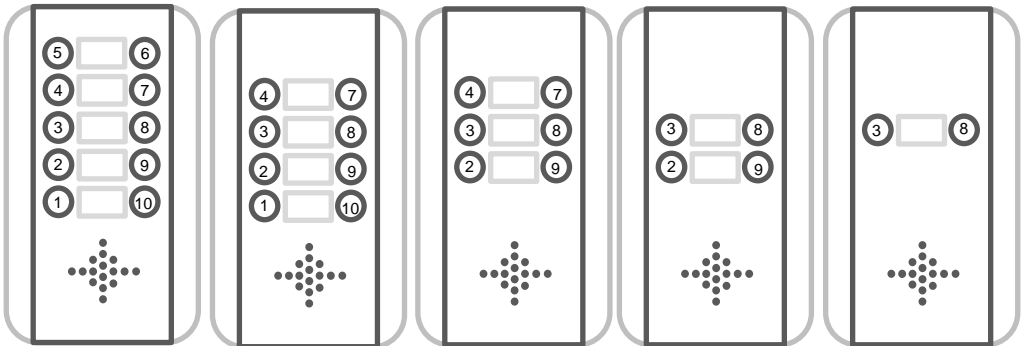

Please note the position of the buttons on the above panel options. For example, if you have a 2 button panel, you will be programming dial out numbers for buttons 3 and 8. For a 4 button panel, the corresponding button locations are 2,3,8 and 9.



Step3: Programming Caller ID access numbers (100 max).

1. Press the CALLER ID button.
2. Simply enter cell phone numbers of visitors whom should have access with caller ID (up to 8 at a time).
3. Press SAVE. Note: iphone users will be taken to their SMS screen to confirm the SMS string (press send).
4. The intercom should reply with an SMS to your phone showing the SMS string and an OK status.

To delete, enter number above and press delete

SMS Programming Method:

Add numbers -

9999#72telephonenumber#72telephonenumber#

Delete specific number –

9999#73telephonenumber#

Delete all –

9999#73*#

Programming Additional Features

The intercom should now be able to call users and have some basic Caller ID access. Now you may wish to program additional features for the client, including keypad codes, dialling times (to avoid voicemail on un-answered calls, auto-trigger times etc.

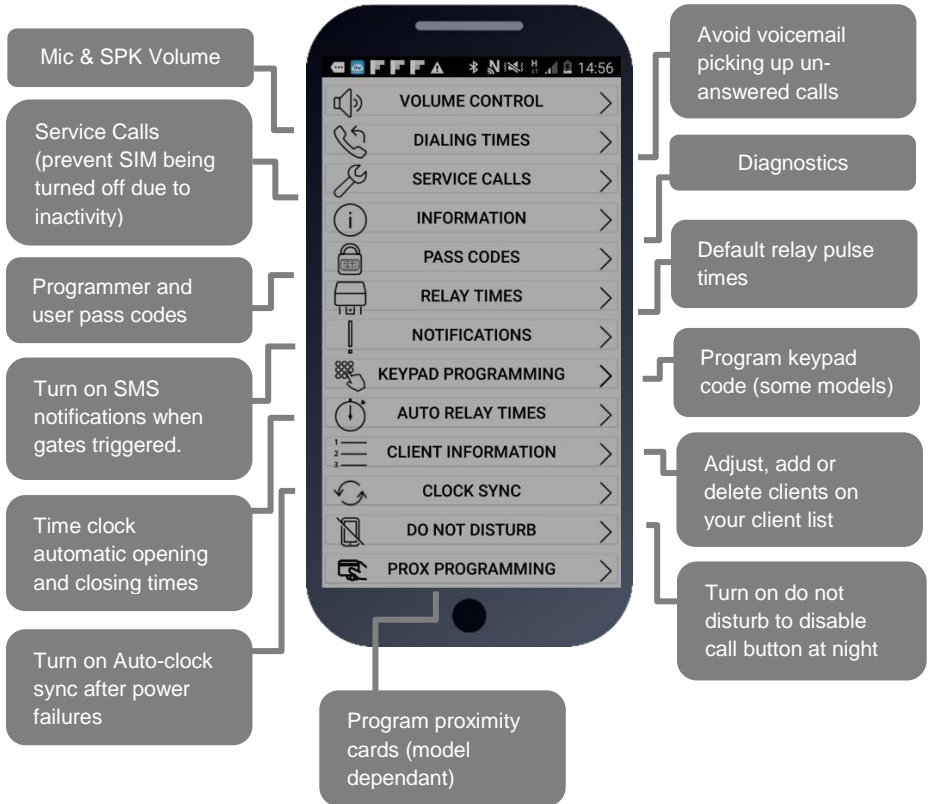

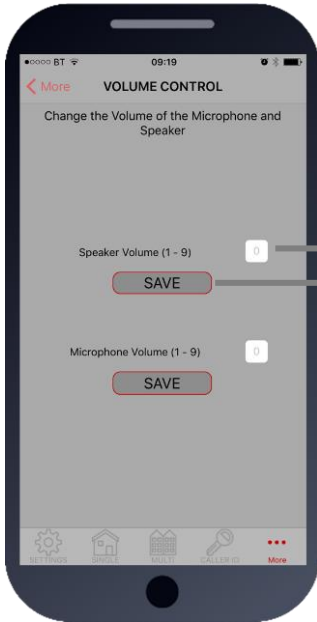

1. Volumes

Adjust speaker and microphone volumes.

Enter required level (1-9) for optimum speech.
 TIP: Set as low as possible for good acoustics.
 Default = 5

Press SAVE.
 TIP: *iPhone users will be taken to SMS screen to confirm message. Android devices will automatically send the SMS.*

SMS string for Speaker Volume:

9999#3X# (X=1-9, default = 5)

SMS string for Microphone Volume:

9999#4X# (X=1-9, default = 5)

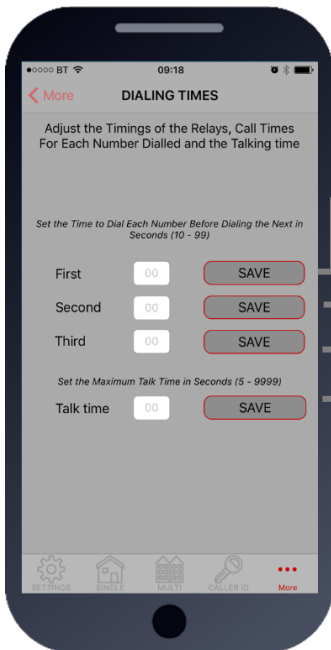

2. Dialling Times & Talk Time

Change ringing times on each number to avoid voicemail picking up a call on un-answered call so the unit can roll over to the next number.

Note: Default 20 secs (includes 5-8 sec connection time).

Dialling time for first number (default 20 secs)

Dialling time for second number (default 20 secs)

Dialling time for third number (default 20 secs)

Set MAX talking time for all numbers (default 60 secs)

SMS strings:

9999#45XX# (X=dialling time for first number)

9999#46XX# (X=dialling time for second number)

9999#47XX# (X=dialling time for third number)

9999#53XXXX# (X= talking time in seconds, 9999 max)

3. Service Calls

This feature is normally only used on intercoms which are seldom used and only for SIM cards which are likely to be de-activated by the network due to inactivity. It can be programmed to make a chargeable outgoing call or SMS to a number of your choice using this screen.

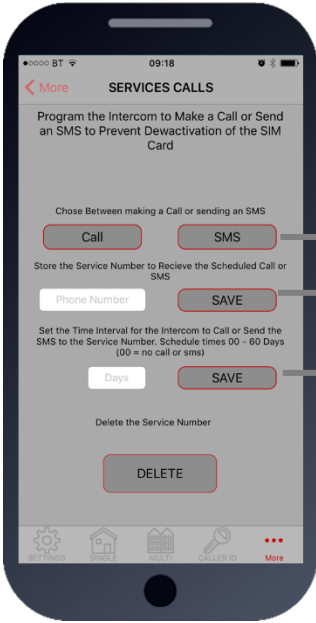

Choose SMS or CALL

Enter the phone number which is to receive the call

Enter the frequency of calls (1-60 days).

TIP: This will call or SMS at the time at which the feature was activated. So, if you set this feature up at 5pm, it will make the service call or SMS at 5pm at the next interval.

SMS string for choosing SMS or CALL:

9999#58X# (For calls, X=2, for SMS, X=1)

SMS string for entering phone number:

9999#77XXXXXX# (X=cell phone number) 77*# to delete.

SMS string for frequency of calls:

9999#57XX#

4. Info

TIP: Iphone users will be taken to SMS screen to confirm message. Android devices will auto send the SMS.

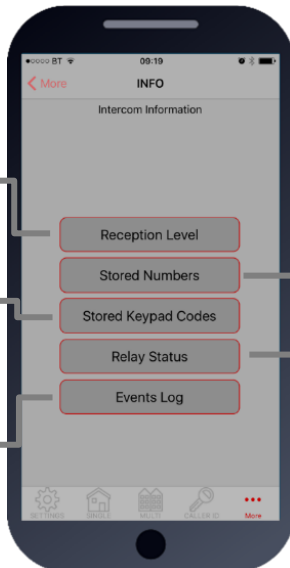

Check signal strength

Check stored keypad codes

Check who opened the gate, when it was opened and by what method

Check stored phone numbers

Check relay status

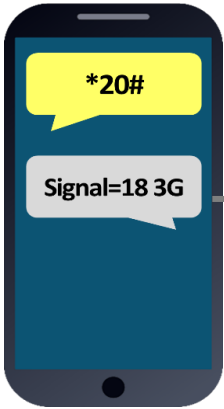

SIGNAL STRENGTH
Will reply with signal range 1-31 Should be higher than 10.

STORED NUMBERS
O=Dial out number.
I=Dial IN Caller ID number.

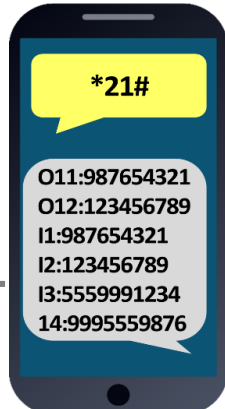

STORED CODES
NORM=Permanent codes.
TEMP=Temporary codes.
PLAN=Time restricted codes.

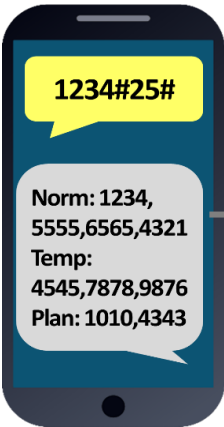

RELAY STATUS
OPEN – Shows status of the input terminals called STATUS on the intercom, can be used with a limit switch. Relay status shown to check if any relay is latched.

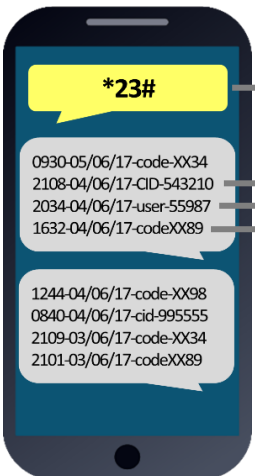
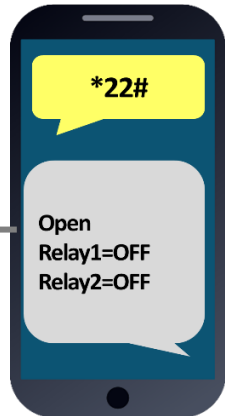

ACTIVITY LOG
Use this to see who used the intercom and when. Which pin codes were used, who used caller ID, who answered the call.
TIP: Time and date is in international military format.

Last 6 digits of caller ID user phone number

Last 6 digits of phone number which answered the gate

Last 2 digits of keypad code used

5. Pass Codes

CAUTION: Take care when changing pass codes. There are 2 levels of 4-digit code (both must be different):

1. Engineers/Programmers code (default 9999)
2. Access/user code (default 1234)

You may wish to change both from their defaults for security.



Restore the app to using default codes (does not restore the intercom)

Enter new programmers code (default 9999)

Enter new user/access code (default 1234)

If changing default codes, then you will now need to update the client list before you can do any further programming. **If the 1234 user access code is changed, then you will also need to change it on the home owners app.**

SMS Strings:

9999#01XXXX# (X=new programmers code)

9999#02XXXX# (X=new user access code)

6. Relay Times

Relay default trigger times are 1 second. Use this feature to change a relay for a longer time perhaps for a magnetic door lock or to make one relay a momentary relay and the other a 1 hour relay for example.

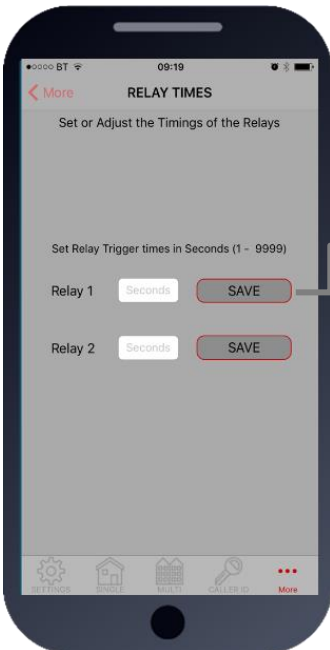

Enter time in SECONDS then press SAVE to send SMS

TIP: Iphone users will be taken to SMS screen to confirm message. Android devices will auto send the SMS.

SMS string for relay 1:

9999#50XXXX# (X=time in seconds, 1-9999)

SMS string for relay 2:

9999#51XXXX# (X=time in seconds, 1-9999)

7. Notifications

This feature is commonly used to allow one home user to receive SMS alerts each time the INTERCOM is used to trigger the gates and grant access.

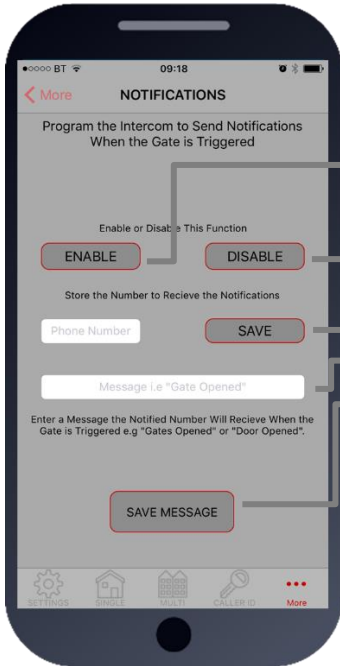

Quick Enable / disable this feature

Enter the phone number to receive the SMS alert and press SAVE

Enter text which you want the user to receive when access is granted, then press SAVE MESSAGE

SMS string for turning ON or OFF:

9999#80X# (X=2 to enable. X=1 to disable)

SMS string for entering phone number to receive notification:

9999#78XXXXXXXX# (X=cell phone number) 78*# to delete.

SMS string for entering text to display:

9999#79XXXXXXXX# (X is any text message you wish to display on the phone. E.g. Gates Opened)

8. Keypad Programming



For Permanent 24/7 Codes

For temporary codes (codes which auto-expire in a pre-set time)

For Time Restricted Codes (codes that work during certain times & days of the week)

For deleting codes

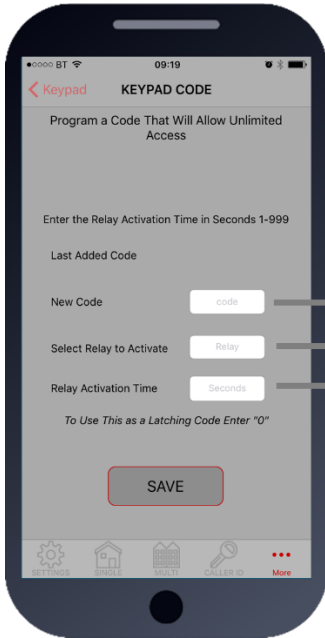

Permanent Keypad Code

Stores up to 200 codes, all of which can be used to gain access 24/7.

Enter 4 digit code

Choose Relay 1 or Relay 2

Enter activation time. (0-9999 seconds)
Use 1 second for gate trigger.
Use approx. 5 secs for magnetic locks.
Use 0 for latching or toggle code.
Use 3600 secs for 1 hour hold open on gates

SMS String for adding keypad codes:

9999#811code#time#

Pass code: 9999
Function code: 811
1 = Relay 1, 2 = Relay 2
4 digit user code: code
=SECONDS: 1-9999, 0 = Latching

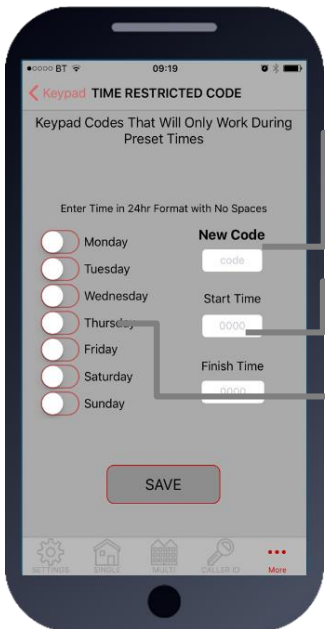

Time (Restricted) Code

Stores up to 20 codes which will only work during pre-set times and days of the week. (Relay 1 only).

Enter 4 digit code

Enter Start and Finish time
(Military format without any colons.
E.g. 8am = 0800. 11pm = 2300)

Select days of the week the code is to be active.

SMS String for time restricted code:

9999#83#day,day,day#time1,time2#code#

Pass code: 9999
Function code: 83
Select days (up to 7) 3 digit format, separate with commas. E.g. mon,tue,wed,thu,fri
Enter start and end time in 24hr 4 digit format (no colon), and separate with comma. e.g. 0800,2300
4 digit code: code

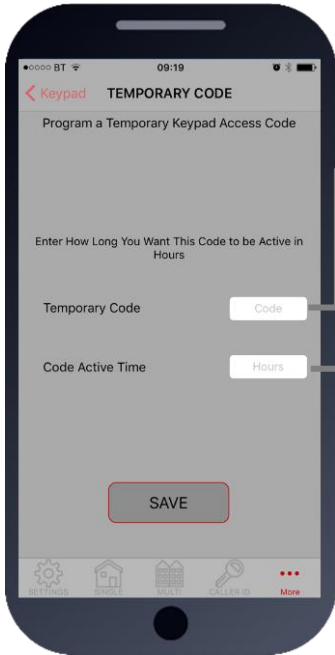

Temporary Code

Stores up to 30 codes at any time which will auto expire after a pre-set countdown time (1-168 hours) (Relay 1 only)

Enter 4 digit code

Enter countdown time in hours (1-168 hrs)

SMS String for temporary code:

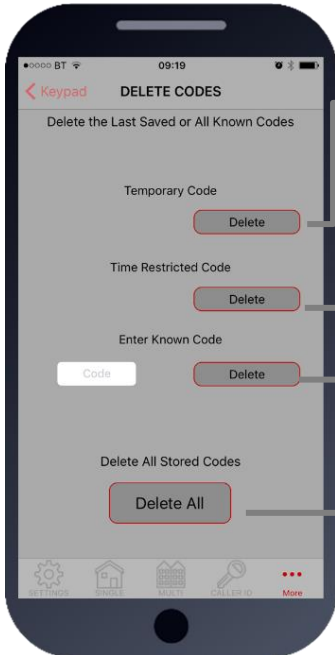
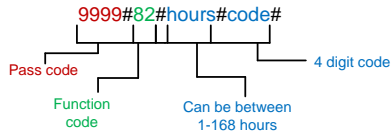

Delete Codes

You can use these buttons to delete a recently stored temp or time restricted code (codes shown beside the delete button)

Delete any known code

Delete ALL codes

SMS String for deleting a known code:

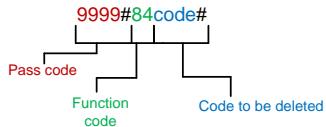

Deleting ALL codes: 9999#84*#

9. Auto Relay Trigger Times

Create up to 40 automatic time clock events to trigger or latch/unlatch gates (depending on gate system setup). For auto closing gates, send latch command at the desired opening time, followed by a separate unlatch event to close at the desired closing time. For step-by-step operated gates (non auto-closing), then send a momentary trigger command at the time required to change the state of the gates from open to closed or closed to open.

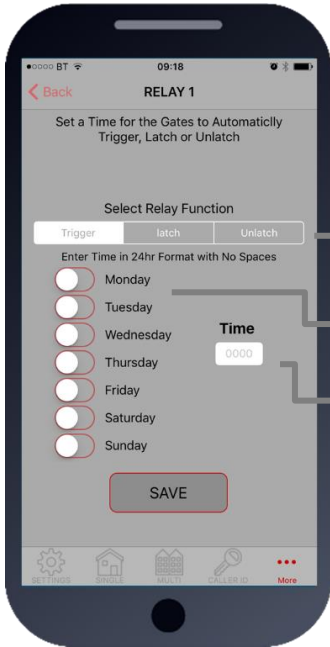

1. Pick the type of event (momentary/latch/unlatch)

2. Choose the days

3. Enter the time in military 24hr format without colon
E.g. 8.30am = 0830. 11:10pm = 2310.

1234#1#day,day,day#time#

USER passcode

Command:
1=trigger relay 1
2=latch relay 1
3=unlatch relay 1
4=trigger relay 2
5=latch relay 2
6=unlatch relay 2

Enter time in 24hr format (no colon)
3 digit format, separate with commas.
E.g. mon,tue,wed,thu,fr

Select days (up to 7)

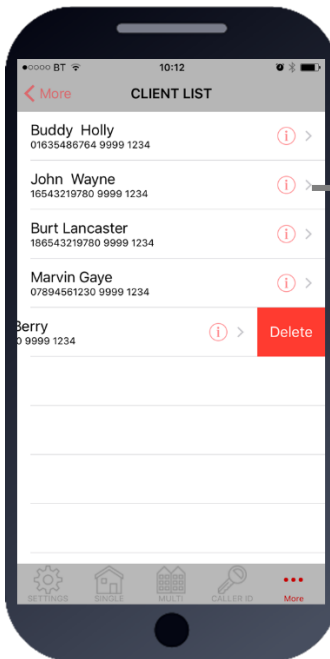

10. Client list on iphone

The client list allows you to save sim phone number, customer name and pass codes for all your installs.

Press to select Client

Swipe to delete

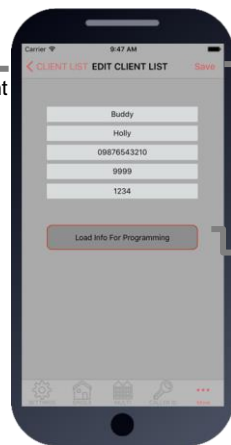

Press to SAVE after editing

Press to load details & program

On any previous install, you can load the customer and then re-program their intercom.

10. Client list on android

The client list allows you to save sim phone number, customer name and pass codes for all your installs.

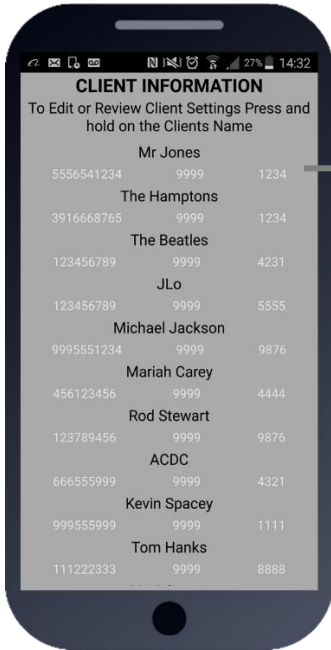

Press & HOLD to select Client

Press to load details & begin programming

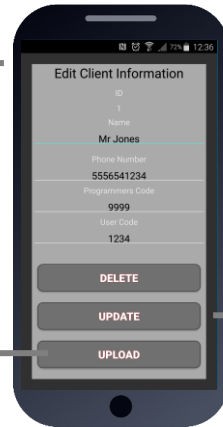

Press to save changes

On any previous install, you can load the customer and then re-program their intercom.

11. Clock Sync

The unit has an internal time clock counter, which reads the time from an incoming SMS message, and uses this to calibrate its time clock.

For power failure events, this feature allows the unit to send a SMS to itself after a power failure.

Simply press the button and the app will send a SMS string to the intercom storing the phone number from the SIM card inside memory.

TIP: Use this if your area experiences regular power cuts and your client is using timed features.

Note: Using this feature will cause the unit to be busy for 2-3 minutes after a reboot. Please be patient with programming etc after a re-boot.

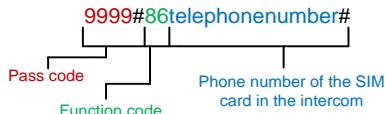
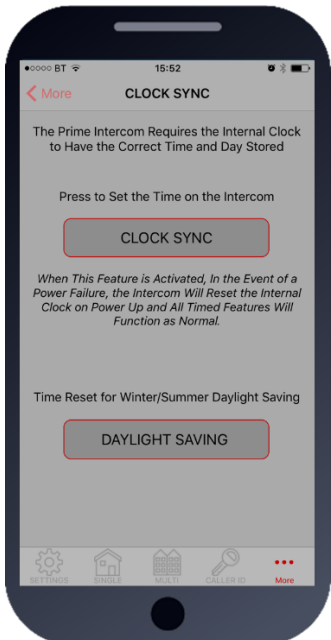

TIP: 9999#86*# will delete this number again

11b. Daylight Saving

For regions where there is a 1 hour time shift for daylight saving, it can be useful to have the intercom send itself a SMS every set number of days to re-synchronise the internal clock. The intercom will do this anyway each time a SMS is received.

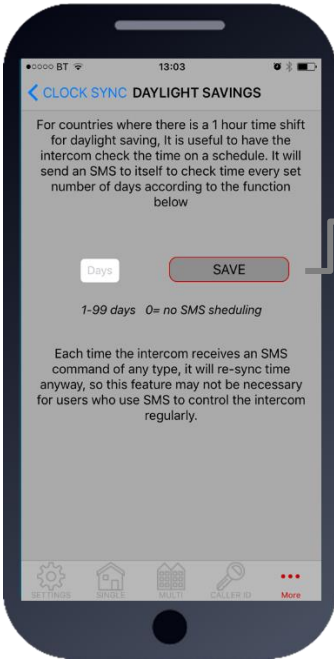

Set the number of days between SMS message sending (depending on carrier provider, this may be chargeable to the customer).

9999#87??#

Pass code: 9999
Function code: 87
1-99 days
0= no SMS scheduling

12. Do not disturb

This feature allows the push button on the intercom to be active during pre-set times, and ignore button presses all other times.

Use this screen to set the **ACTIVE** times and days for the button.

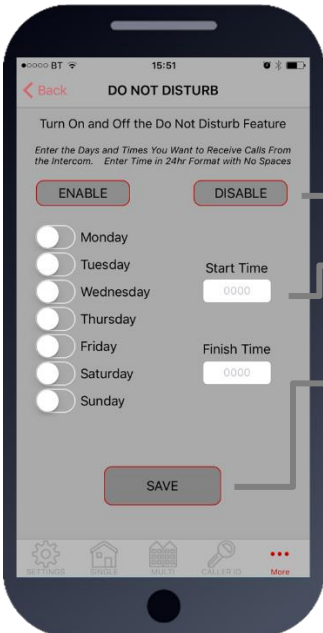

Quick enable/disable button

Select start and finish times for the button to work (24hr format, no spaces or colon. E.g. 8:30am = 0830)

Press save to send SMS command.

9999#21#day,day,day#time1,time2#

Pass code: 9999
Function code: 21
day,day,day: Select days (up to 7) 3 digit format, separate with commas. E.g. mon,tue,wed,thu,fr
time1,time2: Enter start and end time in 24hr 4 digit format (no colon), and separate with comma. e.g. 0800,2300

To activate, enter the following code:

1234#21#ON# (change ON to OFF to disable again).

12b. After Hours / Out of Hours

If you have activated the do not disturb feature, the push button will not call anyone after the pre-set time threshold. However, sometimes it is useful to have the intercom call a different number after hours. For example, in commercial premises it can call the office phones during business hours, and then call a security guard after hours.



1. Enter phone number to call after hours.

2. Enter button number (enter 1 for single button system)

3. Press SAVE to confirm and send SMS

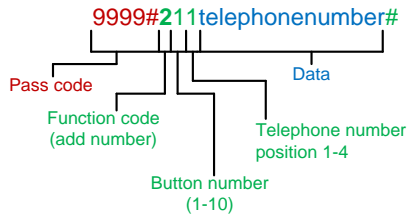

13. Programming Proximity Cards

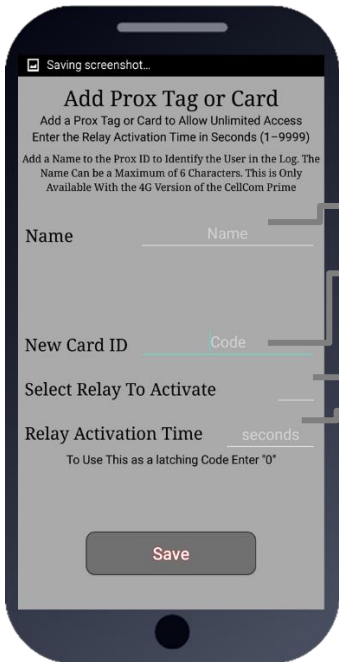
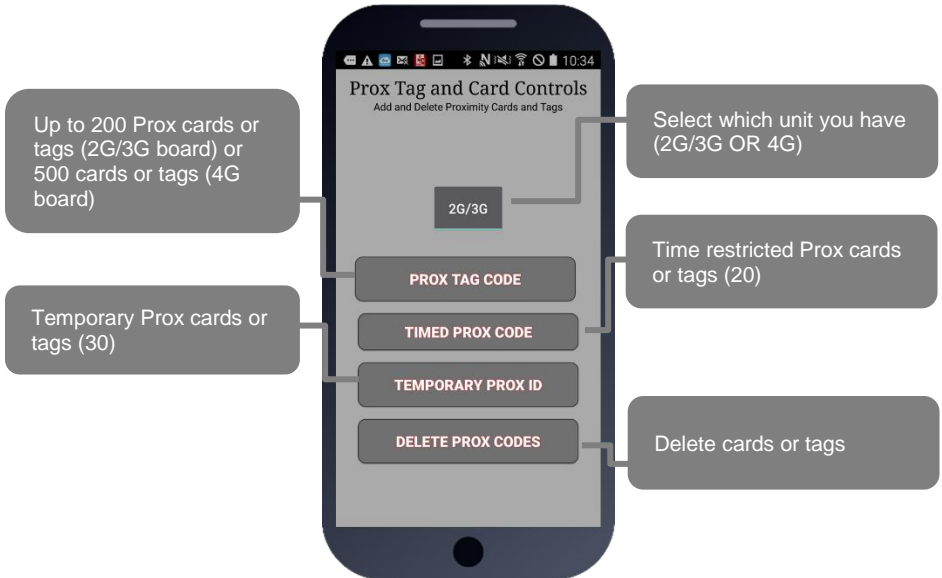

13a. Permanent Prox card/tag

Add up to 200 cards or tags for RFID access.

Note: On 4G version, you may enter a nickname for a card which can be useful when identifying card users later. For 2G and 3G versions, ignore the name field.

Enter nickname up to 5 digits long.

Enter the 10 digit card ID number.

Select relay 1 or 2.

Enter relay activation time in seconds.

SMS String for adding Prox cards/tags:

9999#611cardID#time#

Pass code: 9999
Function code: 611
1 = Relay 1
2 = Relay 2
10 digit card ID: cardID
=SECONDS: time#
1-9999
0 = Latching

13b. Time Restricted card/tag

Add up to 20 cards or tags for time restricted access for certain times or days of the week (relay 1 only).

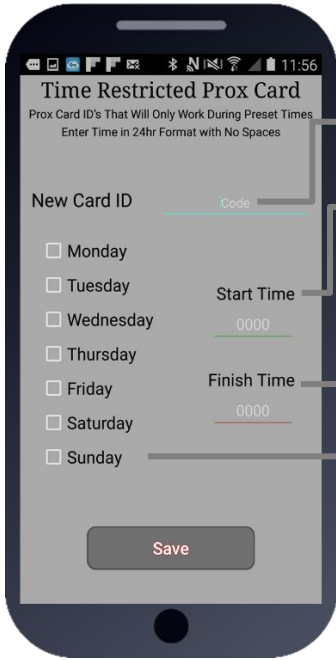

1. Enter serial number of card (last 6 digits).

2. Enter start time (24hr format, no colon or spaces)

3. Enter end time (24hr format, no colon or spaces)

4. Select days of the week

SMS String for time restricted card/tag:

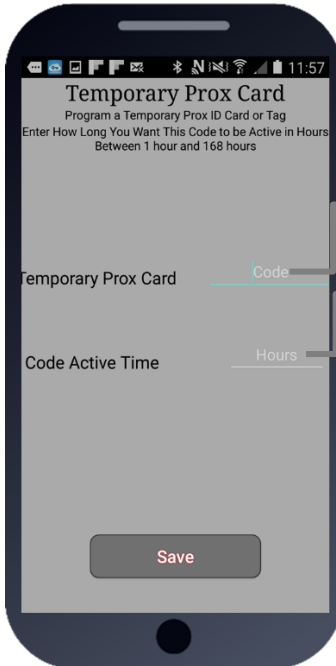
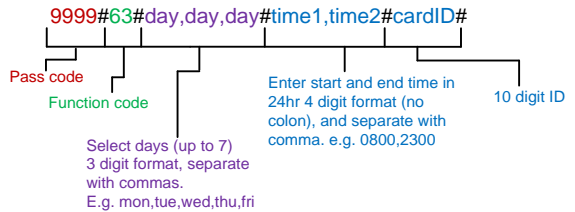

1. Enter serial number of card.

2. Enter countdown time in hours.

SMS String for temporary card/tag:

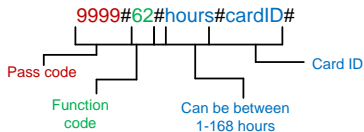

13c. Temporary card/tag

Add up to 30 cards which will only be active for a certain time period, from 1-168 hours and then will be auto deleted from the system.

13d. Deleting cards

This screen allows any known card ID to be deleted (by serial number), and it will also show the last stored cards for each type of card.

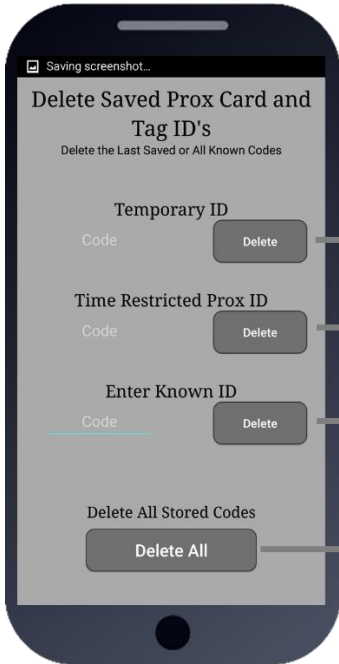

Delete the last stored temporary card.

Delete the last stored time restricted card.

Delete any known card ID.

Delete ALL stored cards.

SMS String for deleting a known code:

9999#64cardID#

Pass code Function code Card ID to be deleted

Deleting ALL codes: 9999#64*#

Complete list of parameters

The table below show the complete list of features.

Changing pass codes

9999#01????#	Change programming password	9999
9999#02????#	Change access control password (SMS control of relays, or non-stored numbers can call intercom & enter code to activate output 1).	1234
9999#03????#	Change monitoring mode password (user can call the intercom, enter this pass code to listen in and speak)	5555

Dial out numbers

9999#1XY????#	Store dialling out numbers. (X = button number 1-9 & 0 for button 10) (Y = number dialled 1-4) (???? = phone number)	N/A
9999#1XY*#	Delete a dial out number. (X = button number) (Y = number position 1-4)	N/A

Volume controls

9999#3?#	Speaker volume. Where ? = 1-9. 1 = lowest, 9 = highest.	5
9999#4?#	Microphone volume. Where ? = 1-9. 1 = lowest, 9 = highest.	5

Timings

9999#50?#	Relay 1 time. ? = seconds, 1-9999	1 sec
9999#51?#	Relay 2 time. ? = seconds, 1-9999.	1 sec
9999#45??#	Calling time for first number, adjust this to avoid voicemail picking up a call (10-99 secs)	20 secs
9999#46??#	Calling time for second number, adjust this to avoid voicemail picking up a call (10-99 secs)	20 secs
9999#47??#	Calling time for third number, adjust this to avoid voicemail picking up a call (10-99 secs)	20 secs
9999#53????#	Talking time. 5-9999 seconds.	60 secs
9999#55??#	Max monitoring time (for listen in mode when calling the intercom) 00-60 mins. 00 = no limit.	10 mins

Scheduled service calls

9999# 77number#	Store a service number to receive a scheduled call or SMS from the unit. Useful for SIM cards which are not often used to prevent switch off by the network provider.	N/A
9999#57??#	Set the time schedule for the intercom to make a scheduled call or SMS to the service number. 00-60 day time schedule. 00 = no call or SMS.	00
9999#58?#	Choose between making a scheduled call or scheduled SMS. 1 = SMS. 2 = call.	1
9999#77*#	Delete the stored service number	N/A

Caller ID features

9999# 72number#	Store caller ID number. Max 14 digits. Only last 6 digits compared.	N/A
9999# 73number#	Delete caller ID number.	N/A

9999#73*#	Delete all caller ID numbers	N/A
-----------	------------------------------	-----

Service & diagnostic messages (no passcode required for some of these!)

*20#	Check reception level 1-31 (no passcode needed)	N/A
*21#	Check stored numbers. O = dial out number. I = dial in number. E = end of message. (no passcode needed)	N/A
*22#	Check input status and relay status. (No passcode needed)	N/A
*23#	Sends SMS messages of the last 20 events.	N/A
1234#25#	Check stored keypad codes.	N/A

Keypad Programming

9999# 81Xcode#time#	Permanent codes - X=1 or 2 for relay 1 or 2. Code = 4-6 digits. Time = 1-9999 seconds, or 0 for latching code.	N/A
9999# 83#day,day,day #time1,time2# code#	Time restricted codes Day = day of the week e.g. mon,tue,wed,thur,fri. Time1 = start time. Time2 = end time (24 hr format, no colon. E.g. 11:30pm = 2330. 8.30am = 0830. Code = pin code 4-6 digits.	N/A
9999# 82#hours# code#	Temporary codes Hours = time to expire in hours (1-168 hours). Code = Pin code 4-6 digit code.	N/A
9999#84code#	Delete code – Code=known code to be deleted.	N/A
9999#84*#	Delete all codes.	N/A

Prox Card/Tag Programming

9999# 61Xcode#time#	Permanent codes - X=1 or 2 for relay 1 or 2. Code = 4-6 digits. Time = 1-9999 seconds, or 0 for latching code.	N/A
9999# 63#day,day,day #time1,time2# code#	Time restricted codes Day = day of the week e.g. mon,tue,wed,thur,fri. Time1 = start time. Time2 = end time (24 hr format, no colon. E.g. 11:30pm = 2330. 8.30am = 0830. Code = pin code 4-6 digits.	N/A
9999# 62#hours# code#	Temporary codes Hours = time to expire in hours (1-168 hours). Code = Pin code 4-6 digit code.	N/A
9999#64code#	Delete code – Code=known code to be deleted.	N/A
9999#64*#	Delete all codes.	N/A

Notifications

9999#80X#	X=1 to disable. X=2 to enable.	N/A
9999#78XXX#	X=phone number to send notifications to. (*=delete number)	N/A
9999#79text#	X=text to send to the receiving phone e.g. "gate opened"	N/A

Automatic Time Clock Trigger Times

1234#X# day,day,day# time#	X=1,2,3 (trigger, latch, unlatch relay 1) 4,5,6 (relay 2) Day = days of the week (mon,tue,wed,thur,fri,sat,sun) Time = time of day (24 hr format, no colon. E.g. 8:30am = 0830)	N/A
1234*X#	Delete ALL automatic trigger times.	N/A

Clock Sync - Auto Time Calibration after Power Fail

9999#86XXX#	X=telephone number of SIM inside the intercom.	N/A
9999#86*#	Delete the phone number.	N/A

Summer Daylight Auto Correct

9999#87??#	?? = number of days between SMS calibration SMS should be sent. 0 = no message sending.	N/A
------------	---	-----

Do Not Disturb (push button de-activated during set times)

1234#21#ON#	ON = activated. OFF = de-activated.	OFF
9999# 21#day,day,day #time1,time2#	Enter all active days during which button should operate. Enter start and end time button should operate (24 hr format, no colon. E.G 8:30am = 0830)	N/A

Alternate Number to Call During Do Not Disturb Times.

9999# 21X????#	X = button number (1-9. Enter 1 for 1 button system. Enter 0 for button 10) ???? = Alternative phone number to call out of hours.	
-------------------	--	--

Restore Defaults

9999#999#	Send with passcode string to clear all programming.	N/A
-----------	---	-----

Troubleshooting

Please see faults in order of most common...

1: Not detecting network (blue light flashing 5 times in search mode, no green CPU light).

A: SIM card not detected. Power off, remove, clean sim contacts and re-insert and power on again.

A: SIM card inserted wrong way round. Check manual for correct orientation.

A: SIM is a data sim, or has not been activated.

A: SIM has no signal in the area.

A: Antenna not connected.

A: Too many sharp bends on antenna cable.

A: Antenna mounted too low or inside metal enclosure.

A: Power cable from 24v psu is too long or too thin. Refer to manual for guidelines.

2: Not responding to SMS messages and not making outgoing calls.

A: No credit on SIM card.

A: Power cable not within spec. Refer to manual for guidelines.

3: Not triggering gates or lock when activated from phone.

A: Check relay with multi-meter.

A: Check relay 2 with multi-meter. If relay 2 works but relay 1 does not, then relay 1 may be defective.

A: Check power cable is within specifications according to this manual.

A: Check if it works by SMS. Try latching a relay then use the status button to check if the relay is latched. If that works, problem could be the phone being used, or low signal strength at the intercom.

3: Poor sound or buzzing

A: Ensure there is no spare antenna cable inside the call point with the intercom. Straighten excess cable.

A: Install the antenna further away from the intercom.

A: Check the power cable is within guidelines of this manual.

4: Home owner app not working correctly

A: Check the settings on the app has the intercom SIM number and pass codes entered correctly.

Change History

Key:

P = Panel version H = Hardware PCB version S = Software version

Version			Reason for change
P	H	S	
1	1	1	First version.
1	2	1	Power chip upgraded to work on 24v dc (24v adaptor in kits).
1	2	2	Software feature added for call log to show last 25 caller ID calls.
1	3	2	Main capacitor, regulator & diode upgraded for 24v ac.
1	4	2	Micro Sim Holder and complete board respin
1	4	3	Caller ID fix for international + symbol. (October 2016)
1	5	4	PRIME model, new firmware plus larger flash storage. (November 2016)
1	6	4	SMA connection directly on the board, micro sim and 24v PSU (July 2017)
Prime6 begins here			
1	1	1	-First version, with slave keypad connections. -Prox option. -Architectural panels have call button in centre.

EU-RED Declaration of Conformity

Manufacturer: Advanced Electronic Solutions Global Ltd

Address: Unit 4C, Kilcronagh Business Park, Cookstown, Co Tyrone, BT809HJ, United Kingdom

We/I declare, that the following equipment (GSM Cellular Intercom System), part numbers:

Multiple Model kit part numbers: GSM-5AB, GSM-5ABK, GSM-5HB, GSM-5HBK, GSM-5IMP, GSM-5IMPK, GSM-FB, GSM-5FBK.

Complies with the following essential requirements for 2014/53/EU:

ETSI draft EN 301 489-1 V2.1.1 (2017-02) (Electromagnetic compatibility)
ETSI draft EN 301 489-52 (2016-11) (Electromagnetic compatibility, specific to cellular)
(WCDMA Band 1, Band 8, GSM 900 / 1800).
Test report number LCS170721023AE

ETSI EN 301 511 V12.5.1 (2017-03) (3.2 of directive 2014/53/EU)
ETSI TS 151 010-1 V12.8.0 (2016-05) (Digital cellular telecoms compliance)
Test report number LCS170721025AE

ETSI EN 301 908-1 V11.1.1 (2016-07) (IMT Cellular networks, 3.2 of directive 2014/53/EU)
ETSI EN 301 908-2 V11.1.1 (2016-07) (CDMA spread / UTRA FDD)
Test report number LCS170721026AE

EN 62311 :2008 (Electromagnetic safety and human exposure)
Test report number: LCS170721027AE

EN 60950-1, (A1, A11, A12, A2)
EN 62311

The notified body is: Telefication BV (CAB number 0560).
This declaration is issued under the sole responsibility of the manufacturer.
Signed by:



Paul Creighton, Managing Director. Date: 1-Feb-2018

Australia / New Zealand Approvals:

This product is not a complete product until fully installed. It is therefore considered a component part of an overall system. The installer is responsible to check that the end installation complies with local regulatory requirements. This equipment forms part of a "fixed installation".

The manufacturer cannot legally offer technical support to non-qualified gate or door installers. End users should employ the services of a professional install company to commission or support this product!

