

NUPI 66

Oil-hydraulic actuator for double swinging gates

Instructions manual

pages 9-16

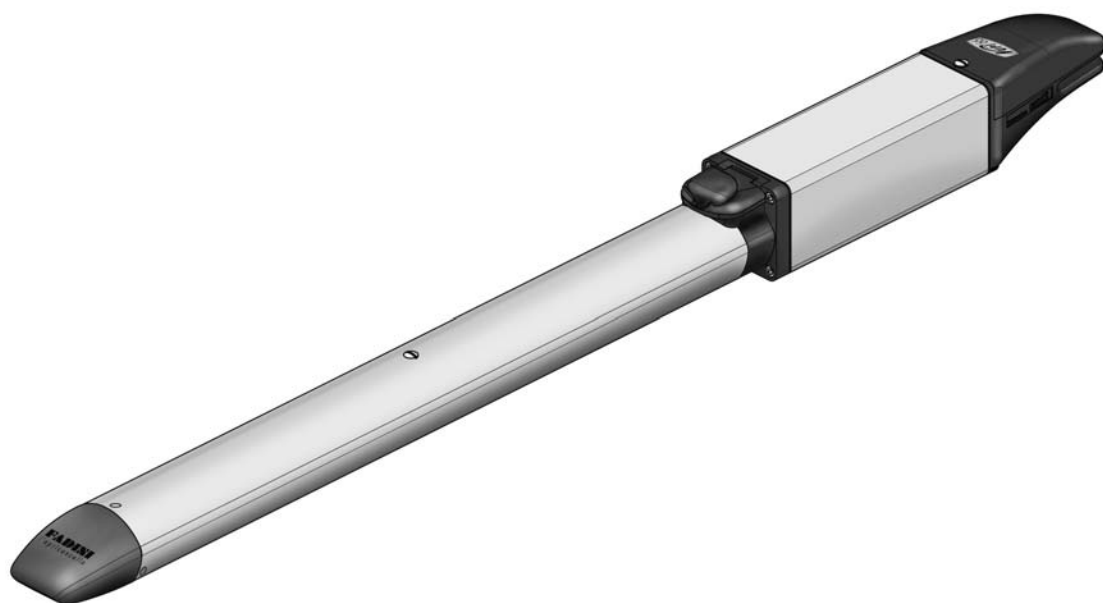

CE

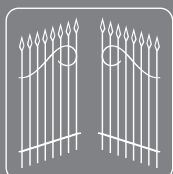

FADINI[®]
the gate opener
Made in Italy

GB



FADINI[®]
the gate opener
Made in Italy

NUPI 66 FITTING INSTRUCTIONS

Important: Keep to the instructions outlined in the pages and diagrams that follow to achieve a perfect installation.

NUPI 66 is an oil-hydraulic actuator locking in the closed gate position to operate gates that are not wider than 2.0 m. Fixing to the gate and gate post is by specially designed brackets. Peculiar with this operator is the absence of the high/low pressure valves, power is set and controlled by the electronic control box ELPRO 7 RP (See the description as from page 12, Elpro 7 RP wiring diagram).

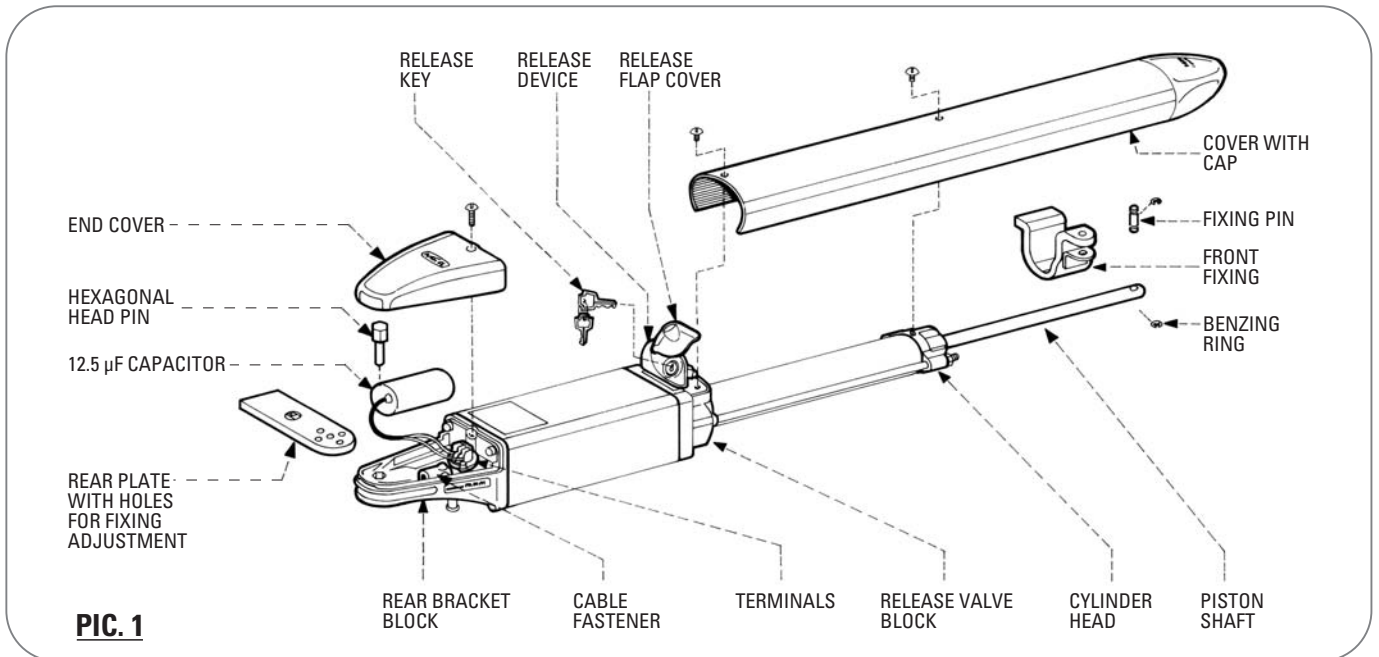

FITTING NUPI 66

This explains how to remove the operator cover and fix the actuator. The first operation is to unlock the operator: push the **lock flap** to one side, insert the **key** and turn it 90° clockwise. The **locking barrel** can be tilted open and the operator is now released (pic. 2). Unscrew the two screws that fix the operator cover and remove it. Unscrew the screw that fixes the **rear end cover** and remove it. The actuator is so ready for fixing operations.

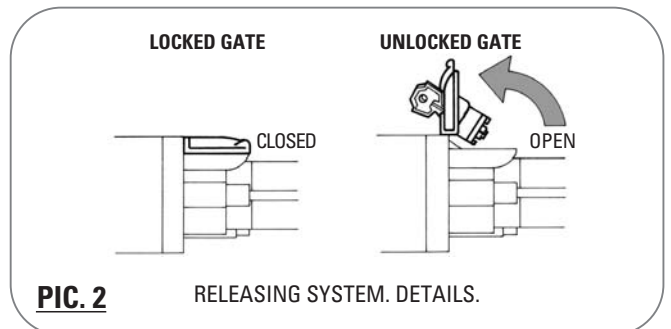

• Special fitting

There can be cases where special fitting requirements are needed to meet (gate hinges on the post edge line, brickwork to be indented, special opening,...). NUPI 66 is supplied complete with an adjustable **rear fixing plate**: a pattern of fixing holes makes the rear fixing extremely versatile to suit any gate. Refer to the diagram on the right for fixing geometry (pic. 3).

ELECTRIC LOCK

An electric lock is recommended in installations where each gate leaf exceeds 1.8 meters and is subjected to high winds or are close boarded gates.

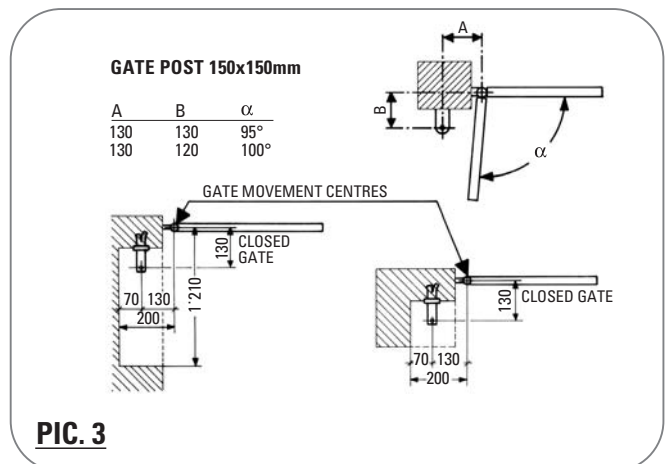

IMPORTANT: It is important to temporarily fix the operator **rear casting** using the center hole in the **fixing plate** and, once the installation is completed, move the **rear fixing** to the inner hole.

IMPORTANT: it is necessary to firmly fix the gate stops to the ground in the open and closed gate positions (See pic. 5 on page 11 and pic. 7 on page 12, parts 5 and 15) before installing the operator.

- A **reinforcement plate** (pic. 6) is recommended for the **rear fixing**, either to be embedded in the gate post, anchoring plates to be welded to improve holding, or bolted to it so that the operator rear fixing can be welded to it in full respect of the geometry indicated below. See distances A and B in pic.5 (distances are strictly referred to the center lines of the gate hinge and operator rear fixing)

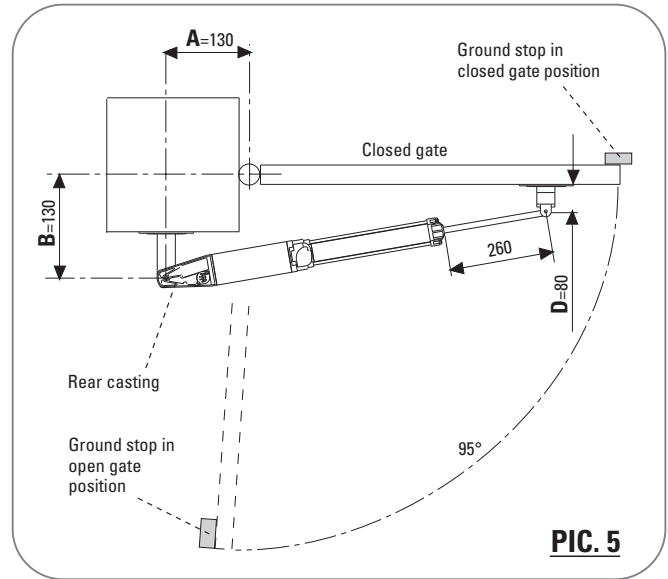
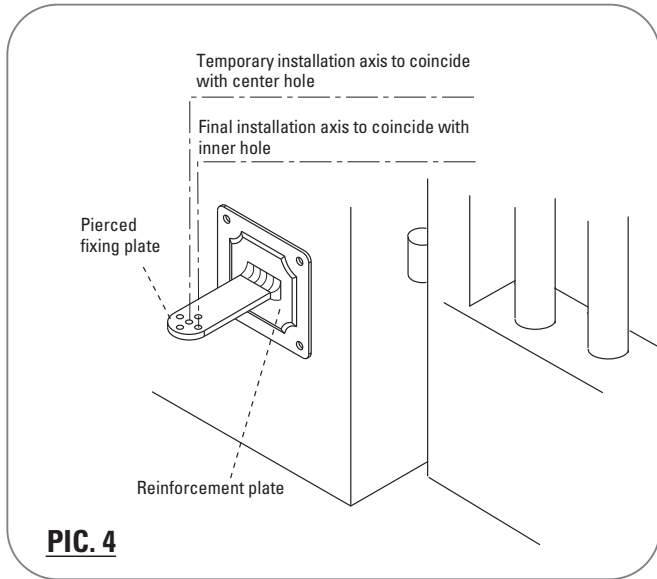

- By means of a spirit level, make sure that the fixing plates are perfectly levelled, respect distance D for the front fixing, the gate in closed position, ie. operator shaft driven 260 mm out.

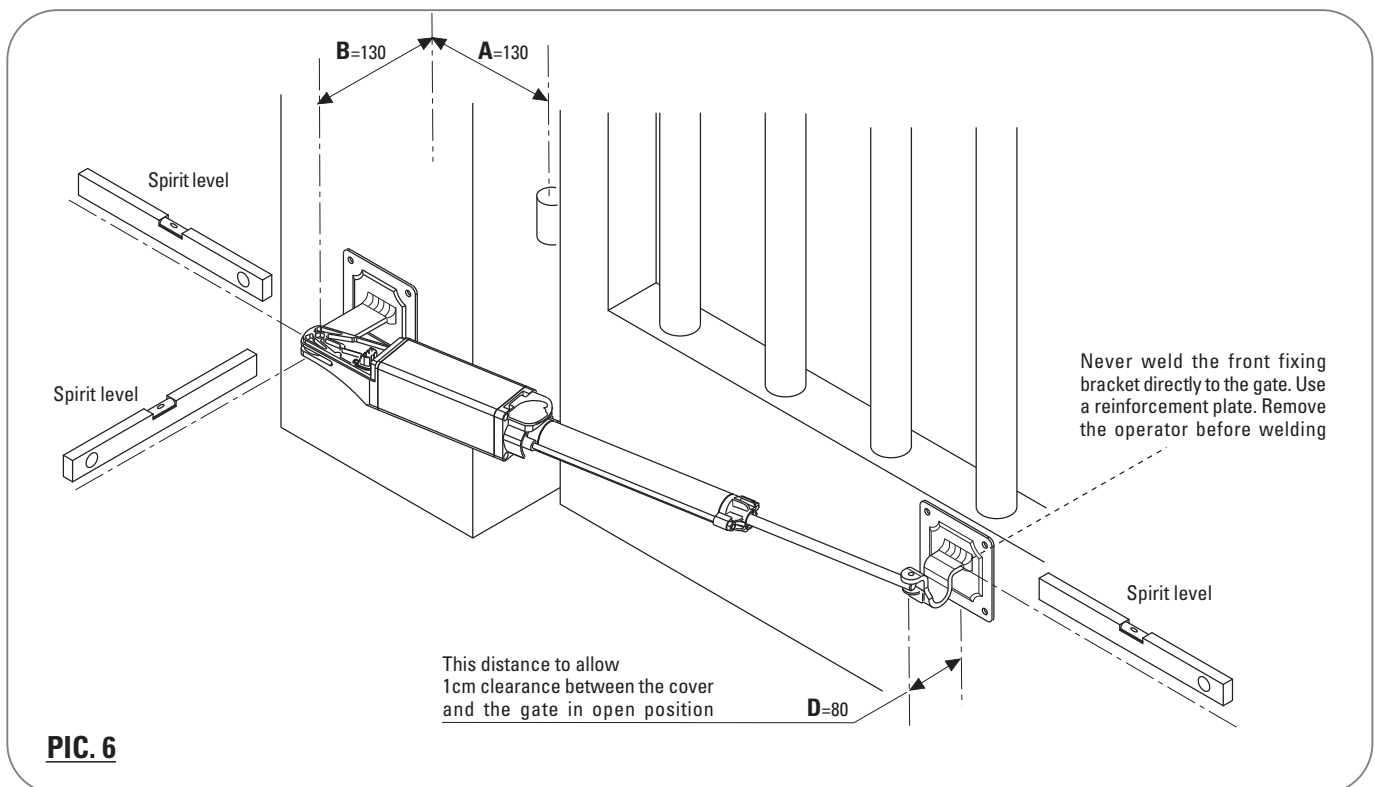

- At this stage NUPI 66 is fixed to the gate leaf. Note that it is locking when the **release lid is closed**; with the lid in the open position the locking device is overridden and the gate can be pushed open by hand (pic.2 on page 10). The electrical connections of the power supply cable to the **terminal board** are the next step. Remove the **cable fastener**. Connect the **neutral to the central terminal** and the two live wires to the lateral terminals (pic. 9 on page 12) **in parallel** with the **capacitor**. Put back the **cable fastener**.

On connecting the electronic control panel **Elpro 7 RP**, it is advised to set the **torque control switch to position 3** (pic. 10 on page 13 and pic. 11 on page 14).

ELECTRICAL WIRING DIAGRAM

The diagram here below shows the electrical connections of all the accessories that are available for the system:

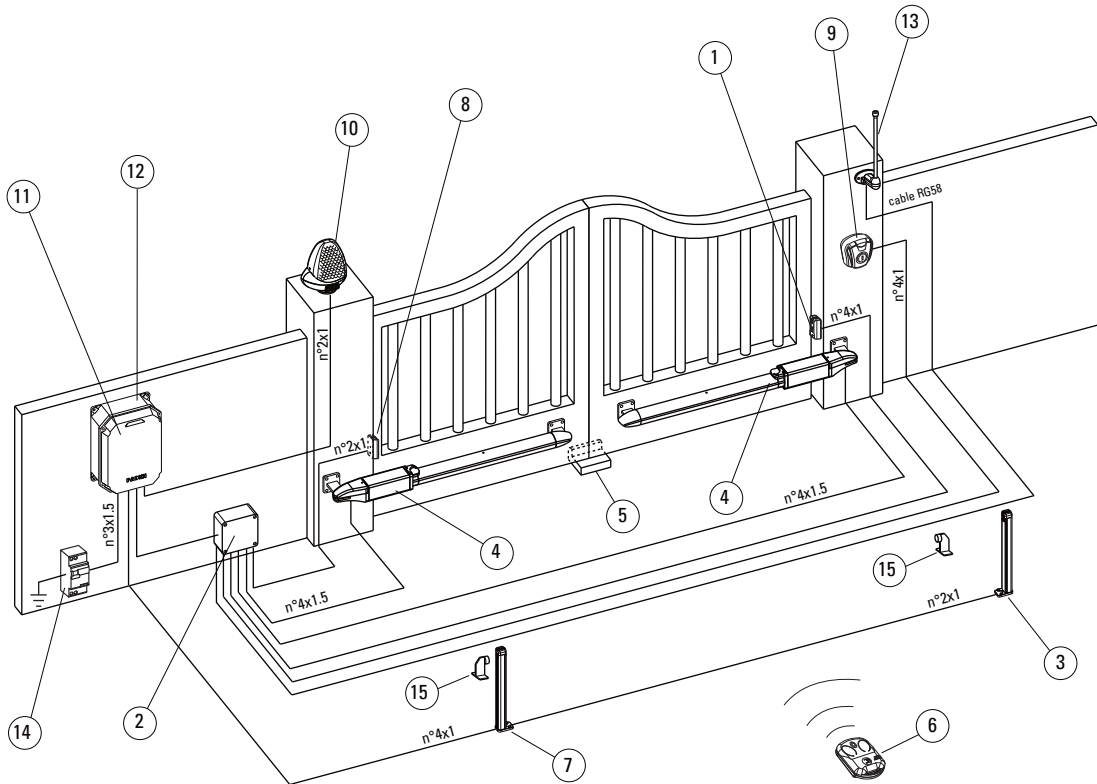

IMPORTANT: All the system must be properly earthed

- | | |
|--|--|
| 1 - PHOTOCELL RECEIVER TRIFO 11 | 9 - KEYSWITCH CHIS 37 SURFACE MOUNT |
| 2 - JUNCTION BOX | 10 - FLASHING LAMP MIRI 4 |
| 3 - POST WITH PHOTOCELL PROJECTOR TRIFO 11 | 11 - PLUG-IN RADIO RECEIVER CARD ASTRO 43/2 R |
| 4 - OIL-HYDRAULIC ACTUATORS NUPI 66 | 12 - ELECTRONIC CONTROL PANEL ELPRO 7 RP |
| 5 - CLOSED GATE STOP REQUIRED | 13 - AERIAL BIRIO A8 |
| 6 - RADIO TRANSMITTER ASTRO 43/2 TR SMALL | 14 - 0.03A MAGNETIC-THERMAL CIRCUIT BREAKER
(BEYOND 100m 2.5mm ² Ø CABLE TO BE USED) |
| 7 - POST WITH PHOTOCELL RECEIVER TRIFO 11 | 15 - OPEN GATE STOP REQUIRED |
| 8 - PHOTOCELL PROJECTOR TRIFO 11 | |

PIC. 7

PIC. 8

TERMINALS FITTED ON TO THE OPERATOR BRACKET BLOCK

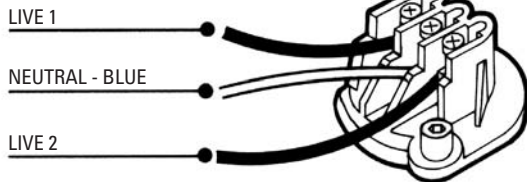

NOTE: BY EXCHANGING THE POSITION OF L1 WITH L2 THE ELECTRIC MOTOR ROTATION IS REVERSED.

PIC. 9

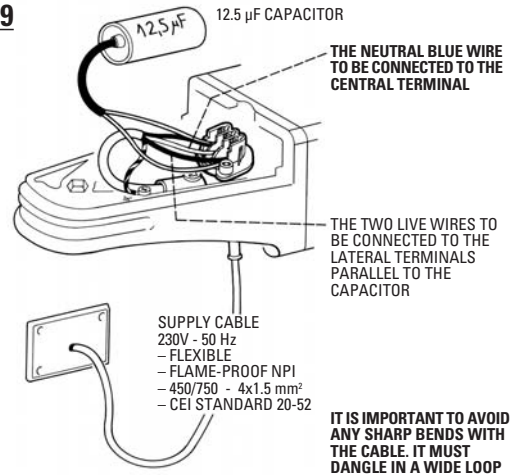

WIRING DIAGRAM CONTROL PANEL ELPRO 7 RP

IMPORTANT: Elpro 7 RP is specifically designed to suit NUPI 66 only. The manufacturer declines any responsibility for damages caused by incorrect use, or applications with accessories that are not FADINI.

For the electrical connections to the motor of NUPI 66 and **mains** use **1.5 mm²** cables.

For the **photo cells, keyswitches, flashing lamp**, and other accessories you can use **1 mm²** wires.

Make sure that all the electrical connections are done in compliance with this diagram.

Once the terminals 19 - 20 are supplied with 230V - 50Hz power, the neutral and live properly connected, the red led No. 1 (L1) illuminates to confirm that the board has voltage.

Read the instructions contained in the ELPRO 7 RP box.

GB

Elpro. 7 RP

*ELECTRONIC CONTROL PANEL FOR NUPI 66
WITH PROGRAMMABLE RADIO TECHNOLOGY*

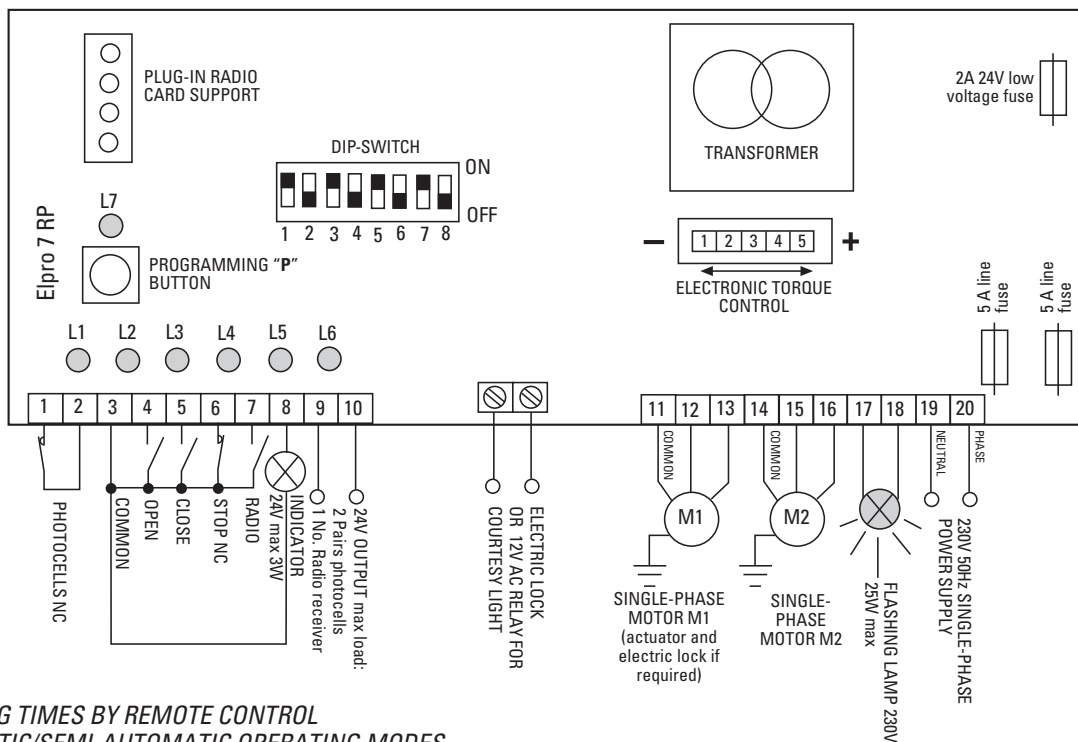

- LEARNING TIMES BY REMOTE CONTROL
- AUTOMATIC/SEMI-AUTOMATIC OPERATING MODES
- STEP BY STEP MODE INTERMEDIATE STOP
- PARTIAL PEDESTRIAN OPENING
- DIP-SWITCH SETTING

PIC. 10

Drwg. No. 4153



Elpro 7 RP is an electronic control panel developed for Nupi 66. The main feature of this unit is the capability to learn the required working times during operation (gate delay in open and close cycles, dwell time). It is recommended to carry out the installation in strict compliance with the rules of good technique and fit the system with ground stops in the Open and Closed positions.

Elpro 7RP is to be powered with 230 V single-phase voltage. It is manufactured in conformity to 2006/95 CE Low Voltage Safety Norms and 2004/108/CE and 92/31 CEE Norms for the Electro Magnetic Compatibility. Installation is to be carried out by qualified technicians in compliance with the existing safety regulations. The manufacturer is not liable for incorrect use of the equipment and reserves the right to do changes to the unit and this manual any time.

English

DESCRIPTION OF FUNCTIONS OF THE CONTROL PANEL FOR SWINGING GATES

ELECTRICAL CONNECTIONS:

- The control panel must be installed in a sheltered, dry place, inside the box provided with it.
- Fit the mains to the control panel with a 0.03A high performance circuit breaker.
- Use 1.5mm² section wires for voltage supply and electric motor. Maximum recommended distance 50m.
- Use 1mm² section wires for limit switches, photocells, push-buttons/key-switch and accessories.
- Bridge terminals 1 and 2 if no photocells are required.
- Bridge terminals 3 and 6 if no key- or push-button switches are required.

N.W.: To fit extra accessories such as lights, CCTV etc. use only solid state relays to prevent damages to the microprocessor

LOGIC: Elpro 7 RP is supplied with pre-set working times to allow the first installation:

- Working time is about 20 s
- Gate Delay Times:
 - Opening=2 s
 - Closing=6 s
 - Dwell on automatic Mode=15 s

Once satisfied that the system is working all right, new working times can be programmed to meet the user's needs or the installation requirements. Elpro 7RP functions can be set by Dip-switches, both before and after the times have been stored by the unit.

LEARNING THE TIMES: ELPRO 7 RP learning operation is quite easy and can be achieved either by the P button on the PCB or by the remote control after entering setting mode, see point 1).

Starting the unit to learn the required times: with the gate in closed position pulse the equipment to one complete cycle, ie. open-dwell-close. Important:

- 1) In order to avoid setting times which are not suitable to the correct gate functioning, some time limits are pre-set. Beyond these values the automation will start with the maximum pre-set time:
M1 and M2 Motor Run time: max.55s Dwell time on Automatic Mode: maximum 90s
- 2) During the learning operation, no other functions can be activated, the Photocells and the Stop button are out of service
- 3) If the new setting operation is interrupted (for example: mains cut off), the times in the previous setting are memorized.
- 4) Normally, not on programming mode, the P button has the same function as a remote control button and it is possible to test the system by pulsing it; the Led 7 becomes a simple indicator, the same as the indicator to terminal 8.

Led Status Indication:

- L1=230V 50Hz power supply. Alight
- L2=Photocells, if obstructed light goes off
- L3=Open. Alight whenever an Open pulse is given
- L4=Close. Alight whenever a Close pulse is given
- L5=Stop. It goes off on pulsing Stop
- L6=Radio. It goes on by pressing a transmitter button
- L7=Gate Status; and programming led

Dip-Switch:

- 1= ON Photocells, Stop during opening
- 2= ON Radio no reversing during Opening
- 3= ON Automatic Closing
- 4= ON Pre-flashing in service
- 5= ON Radio step by step. Stop in between
- 6= ON No delay on opening
- 7= ON Additional pushing on the gate leaf after closing
- 8= ON Pedestrian opening by Open button

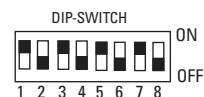
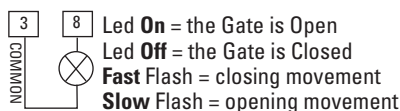
**24V 3W Indicator:****Pedestrian Opening (M1 Motor by Open pulse):**

- Partial opening for pedestrians is only allowed in closed gate position by pulsing to Open (the gate closes after the dwell time if set to Automatic Dip-Switch 3=ON)
- the first pulse operates 1 gate leaf (M1)
- the second pulse operates the second gate leaf

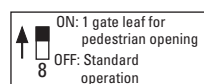

IMPORTANT: The Elpro 7 RP control panel is supplied with open/close time memory.

TORQUE CONTROL SETTING: Adjust torque from lower level (step 1) up to the required amount of power step by step to achieve a correct performance of the system so that the gates are operated as required and any injuring hazard is prevented. Please note, torque is to be adjusted by a technician.

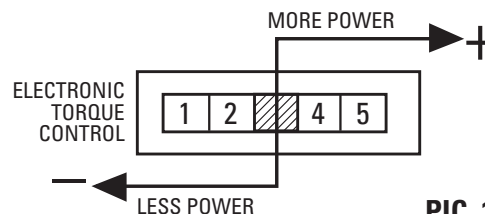

PIC. 11

TORQUE ADJUSTING WHEN LIGHT GATES ARE INVOLVED: (made of timbers, PVC or aluminium etc. ...) replace the existing capacitor with a 8 µF one and adjust torque accordingly starting from step one (lowest setting).



DESCRIPTION OF FUNCTIONS OF THE CONTROL PANEL FOR SWINGING GATES

Preliminary notes to Learning Mode:

- Make sure that the gate is closed
- Make sure that the gate stops in the respective open and closed gate positions are firmly fixed to the ground

1°

1st Operation:

Cut off power supply to Elpro 7 RP by removing the **2A 24V Low Voltage white Fuse**, which is on the right upper side of the PCB



2°

2nd Operation:

Hold the button "P" pressed and re-power the PCB by inserting the **24V Low Voltage Fuse** back into its holder.



3°

3rd Operation:

When the **Led L7** illuminates, release button "P": **Led L7** will flash 5 times and the **flashing lamp** will illuminate: the program "learning working times" has been entered.

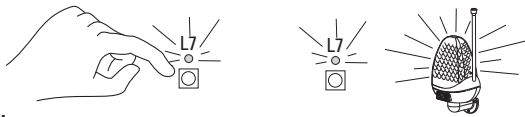

IMPORTANT: at this stage two options are allowed to go on with setting i.e. learning the required operating times: by the "P" button or by remote control. The last option allows the installation agent to have direct visual control of the operation being performed by the gates.

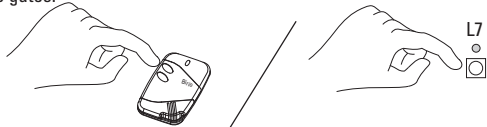

4°

4th Operation:

A pulse to open starts M1 motor
(the first gate starts opening)

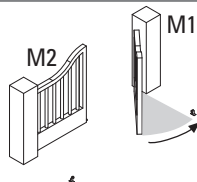
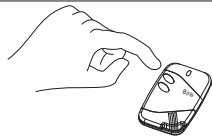

The time passing from 4th to 5th operations is stored by the system as the **Gate Delay Time in Open Cycle**, with the options in service (Dip No.6=ON) or out of service (Dip No.6=OFF, the time is stored but no delay will occur).

5°

5th Operation:

A pulse to open starts M2 motor
(second gate starts opening)

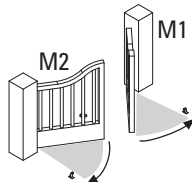
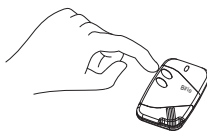

6°

6th Operation:

A pulse stops M1 motor
(first gate wide open on open gate stop)

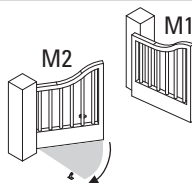
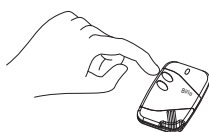

7°

7th Operation:

A pulse stops M2 motor
(second gate wide open on open gate stop)

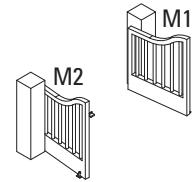
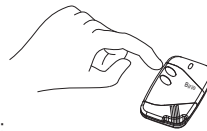

The time passing from 7th to 8th operation is stored by the system as "**Dwell Time**", in service on AUTOMATIC MODE (Dip No.3=ON) or out of service (Dip No.3=OFF, dwell time still in the system memory but not applicable).

8°

8th Operation:

A Pulse to close starts M2 motor
(M2 gate starts closing)

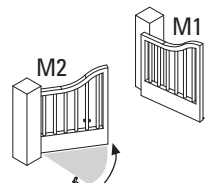

The time between the 8th and 9th operations is stored by the system as "**Gate Delay Time on Closing Cycle**"

9°

9th Operation:

A pulse to close starts M1 motor
(M1 gate starts closing)

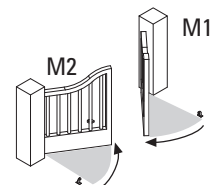
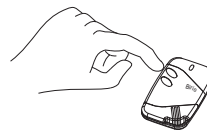

10°

10th Operation:

A pulse stops M2 motor **(M2 gate on closed gate position)**
In order to ensure that the gate is securely held in stop position, it is advised to pulse the actuator i.e. gate to stop approx. 3-4 seconds after the gate has reached the end of the permitted stroke on the closed gate stop position.

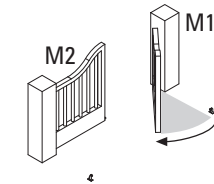
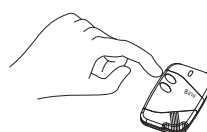

11°

11th Operation:

A pulse stops M1 motor **(M1 gate on closed gate position)**
In order to ensure that the gate is securely held in stop position, it is advised to pulse the actuator i.e. gate to stop approx. 3-4 seconds after the gate has reached the end of the permitted stroke on the closed gate stop position.

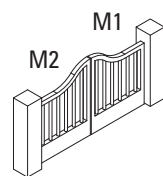
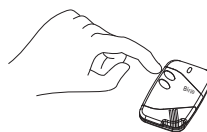

The 11th operation concludes the procedure for the control panel to learn the required working times.
After the learning procedure, it is possible to set the operating modes either ON/OFF as required by means the Dip-switches on the PCB.

NUPI 66 TECHNICAL SPECIFICATIONS

OIL-HYDRAULIC ACTUATOR

Pump flow rate - P5	1.4 ℓ/min.
Working pressure	2 MPa (20 Bars)
Working temperature	-20°C +80°C
Shaft travelling time	21 sec.
Power oil	Oil Fadini
Piston stroke	280 mm
Piston diameter	45 mm
Shaft diameter	16 mm
Pushing power open	2'720 N
Pulling power close	3'120 N
Weight of NUPI 66 complete	8 Kg
Protection standards	IP 553
Overall dimensions (LxWxH)	1'240x86x86 mm

ELECTRIC MOTOR

Power output	0.18 KW (0.25 HP)
Supply voltage	230 V
Frequency	50 Hz
Absorbed current	1.2 A
Absorbed power	250 W
Capacitor	12.5 µF
Motor rotation speed	1'350 rpm
Intermittent service	S 3
Flexible electric cable	CEI 20-52 FROR 450-750 V
Class	H
Gate height and width (mm)	H 1'200, W 1'600
Max. weight per gate leaf up to 2m	150 Kg

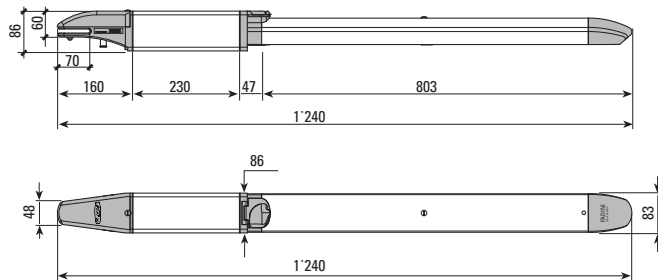

FIG. 12

SERVICE

Duty cycle ...	19 sec. Opening - 30 sec. Stop - 21 sec. Closing - 30 sec. Stop
Time of one complete cycle	100 s
No. of complete cycles Opening - Stop - Closing - Stop	36/h
No. of cycles a year, 8 hours' service a day	105'000

WARNINGS

- Before installing the equipment carry out a **Risk Analysis** and fit any required device in compliance with EN 12445 and EN 12453 Safety Norms.
- It is recommended to keep to the instructions here outlined - check the specifications on the motor sticker with your mains supply.
- Dispose properly of the packaging: cardboard, nylon, polystyrene, through specialized companies.
- Should the operator be removed, **do not cut** the electric cables. These must be properly removed from the terminal board in the junction box.
- Switch off the mains switch before removing the junction box cover where the electric cables are terminated.
- All the system must be earthed by using the yellow/green wire.
- It is recommended to read the regulations, suggestions and remarks quoted in the booklet "Safety Norms".

CHECKS AND MAINTENANCE:

To achieve an optimum performance and longer life of the equipment and in observance of the safety regulations, it is recommended that inspections and proper maintenance are made by qualified technicians to the whole installation ie. both the mechanical and electronic parts, as well as wiring.

- Mechanical parts: maintenance every 6 months approx.
- Electronic apparatus and safety equipment: maintenance inspection monthly.
- Ordinary and extraordinary maintenance to be agreed between buyer and installation agent.



The growth of MECCANICA FADINI has always been based on the development of guaranteed products thanks to our "TOTAL QUALITY CONTROL" system which ensures constant quality standards, updated knowledge of the European Standards and compliance with their requirements, in view of an ever increasing process of improvement.



meccanica FADINI s.n.c.

AUTOMATIC GATE MANUFACTURERS

Via Mantova, 177/A - C.P.126 - 37053 Cerea (Verona) Italy
Tel. +39 0442 330422 r.a. - Fax +39 0442 331054
e-mail: info@fadini.net - www.fadini.net



The manufacturer reserves the right to make amendments to this manual without prior notice and declines all responsibility for any errors, personal injury or damage to property.