

FADINI
l'apricancello
Made in Italy

I

LIBRETTO DI ISTRUZIONI

Elpro • 7 RP

PROGRAMMATORE ELETTRONICO PER NUPI 66
CON TECNOLOGIA RADIO PROGRAMMABILE

- APPRENDIMENTO DEI TEMPI CON RADIO-TRASMETTITORE
- FUNZIONE AUTOMATICO-SEMIAUTOMATICO
- FUNZIONE PASSO-PASSO CON BLOCCO INTERMEDIO
- FUNZIONE AD ANTA PEDONALE
- DIP-SWITCH DI PROGRAMMAZIONE

pag. 1,2,3

GB

INSTRUCTIONS

Elpro • 7 RP

ELECTRONIC CONTROL PANEL FOR NUPI 66
WITH PROGRAMMABLE RADIO TECHNOLOGY

- LEARNING TIMES BY REMOTE CONTROL
- AUTOMATIC/SEMI-AUTOMATIC OPERATING MODES
- STEP BY STEP MODE INTERMEDIATE STOP
- PARTIAL PEDESTRIAN OPENING
- DIP-SWITCH SETTING

page 1,4,5

F

NOTICES D'INSTRUCTION

Elpro • 7 RP

PROGRAMMATEUR ELECTRONIQUE POUR NUPI 66
AVEC TECNOLOGIE RADIO PROGRAMMABLE

- AUTOAPPRENTISSANT DES TEMPS PAR TELECOMMANDE
- FONCTION AUTOMATIQUE-SEMIAUTOMATIQUE
- FONCTION PAS-PAS AVEC ARRET INTERMEDIAIRE
- FONCTION VANTAIL PIETONS
- DIP-SWITCH DE PROGRAMMATION

page 1,6,7

D

ANLEITUNG

Elpro • 7 RP

ELEKTRONISCHE STEUERUNG FÜR NUPI 66
MIT PROGRAMMIERBARER TECHNOLOGIE

- ERLERNUNG DER ZEITEN DURCH FUNKSENDER
- AUTOMATISCHE/HALBAUTOMATISCHE FUNKTION
- SCHRITT-IMPULS-FUNKTION MIT MITTELSTOPP
- GEHTÜRFUNKTION
- DIP-SCHALTER ZUR PROGRAMMIERUNG

Seite 1,8,9

E

FOLLETO DE INSTRUCCIONES

Elpro • 7 RP

PROGRAMADOR ELECTRONICO PARA NUPI 66
CON TECNOLOGIA DE RADIO PROGRAMABLE

- APRENDIZAJE DE LOS TIEMPOS POR MEDIO DE RADIOTRANSMISOR
- FUNCION AUTOMATICO-SEMIAUTOMATICO
- FUNCION PASO A PASO CON BLOQUEO INTERMEDIO
- FUNCION DE HOJA PARA PASO DE PEATONES
- "DIP-SWITCH" DE PROGRAMACION

pág. 1, 10, 11

NL

HANDLEIDING

Elpro • 7 RP

RADIOPROGRAMMEERBARE ELEKTRONISCHE
PROGRAMMEEREENHEID VOOR NUPI 66

- TIJDSLERING MET RADIOZENDER
- AUTOMATISCHE-HALFAUTOMATISCHE FUNCTIE
- STAP-VOOR-STAP FUNCTIE MET TUSSENTIJDSE BLOKKERING
- FUNCTIE MET VOETGANGERSPOORT
- PROGRAMMERINGS-DIP-SWITCH

pag. 1,12,13

Dis. N. 4153



Via Mantova, 177/A - C.P. 126 - 37053 Cerea (Verona) Italy - Tel. +39 0442 330422 r.a.
Fax +39 0442 331054 - e-mail: info@fadini.net - www.fadini.net



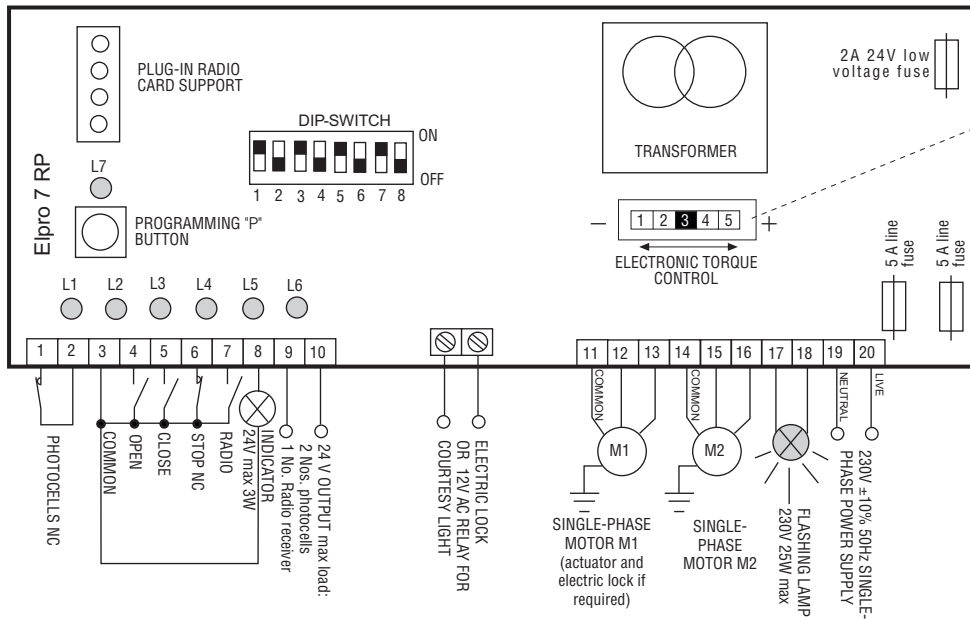

Torque control setting:

Adjust torque from lower level (step 1) up to the required amount of power step by step to achieve a correct performance of the system so that the gates are operated as required and any injuring hazard is prevented. Please note, torque is to be adjusted by a technician.

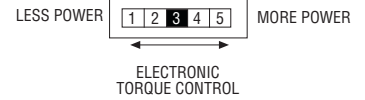

General description: Elpro 7 RP is an electronic control panel developed for Nupi 66. The main feature of this unit is the capability to learn the required working times during operation (gate delay in open and close cycles, dwell time). It is recommended to carry out the installation in strict compliance with the rules of good technique and fit the system with ground stops in the Open and Closed positions.

- IMPORTANT:**
- The control panel must be installed in a sheltered, dry place, inside the box provided with it.
 - Make sure that the power supply to the electronic programmer is 230V ±10%
 - Make sure that the power supply to the Electric Motor is 230V ±10%
 - For distances of over 50 metres we recommend using electric cables with bigger sections
 - Fit the mains to the control panel with a 0.03A high performance circuit breaker.
 - Use 1.5mm² section wires for voltage supply, electric motor and flashing lamp. Maximum recommended distance 50m.
 - Use 1mm² section wires for limit switches, photocells, push-buttons/key-switch and accessories.
 - Bridge terminals 1 and 2 if no photocells are required.
 - Bridge terminals 3 and 6 if no key- or push-button switches are required.
- N.W.:** To fit extra accessories such as lights, CCTV etc. use only solid state relays to prevent damages to the microprocessor

WORKING LOGIC: Elpro 7 RP is supplied with pre-set working times so that to allow the first installation: Working time is about 20 s
 Gate Delay Times: - Opening=2 s - Closing=6 s - Dwell on automatic Mode=15 s
 Once satisfied that the system is working all right, new working times can be programmed to meet the user's needs or the installation requirements. Elpro 7RP functions can be set by Dip-switches, both before and after the times have been stored by the unit.

LEARNING THE TIMES: ELPRO 7 RP learning operation is quite easy and can be achieved either by the P button on the PBC or by the remote control after entering setting mode, see point 1).

Starting the unit to learn the required times: with the gate in closed position pulse the equipment to one complete cycle, ie. open-stop/dwell-close

Important:

- 1) In order to avoid setting times which are not suitable with the correct gate functioning, some time limits were pre-set. Beyond these values the automation will start with the maximum pre-set time:
 M1 and M2 Motor Run time: max.55s Dwell time on Automatic Mode: maximum 90s
- 2) During the learning operation, no other functions can be activated, the Photocells and the Stop button are out of service
- 3) If the new setting operation is interrupted (for example: mains cut off), the times in the previous setting are memorized.
- 4) Normally, not on programming mode, the P button has the same function as a remote control button and it is possible to test the system by pulsing it; the Led 7 becomes a simple indicator, the same as the indicator to terminal 8.

24V 3W Indicator:

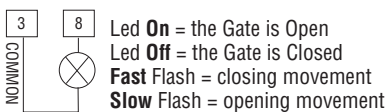

Pedestrian Opening (M1 Motor by Open pulse):

Partial opening for pedestrians is only allowed in closed gate position by pulsing to Open (the gate closes after the dwell time if set to Automatic Dip-Switch 3=ON)
 -the first pulse operates 1 gate leaf (M1)
 -the second pulse operates the second gate leaf

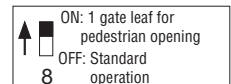

Led Status Indication:

- L1=230V 50Hz power supply. Alight
- L2=Photocells, if obstructed light goes off
- L3=Open. Alight whenever an Open pulse is given
- L4=Close. Alight whenever a Close pulse is given
- L5=Stop. It goes off on pulsing Stop
- L6=Radio. It goes on by pressing a transmitter button
- L7=Gate Status; and programming led

Dip-Switch:

- 1= ON Photocells, Stop during opening
- 2= ON Radio no reversing during Opening
- 3= ON Automatic Closing
- 4= ON Pre-flashing in service
- 5= ON Radio step by step
- 6= ON No delay on opening
- 7= ON No Additional pushing on the gate leaf after closing
- 8= ON Pedestrian opening by Open button



Elpro 7 RP is to be powered with 230 V single-phase voltage. It is manufactured in conformity to 2006/95 CE Low Voltage Safety Norms and 2004/108/CE & 92/31 CEE Norms for the Electro Magnetic Compatibility. Installation is to be carried out by qualified technicians in compliance with the existing safety regulations. The manufacturer is not liable for incorrect use of the equipment and reserves the right to do changes to the unit and this manual any time. **Failure to follow installation regulations may result in serious damage to property and persons.**

**Preliminary notes to Learning Mode:**

- Make sure that the gate is closed
- Make sure that the gate stops in the respective open and closed gate positions are firmly fixed to the ground

1°

1st Operation:

Cut off power supply to Elpro 7 RP by removing the **2A 24V Low Voltage white Fuse**, which is on the right upper side of the PCB



2°

2nd Operation:

Hold the **button "P"** pressed and re-power the PCB by inserting the **24V Low Voltage Fuse** back into its holder.



3°

3rd Operation:

When the **Led L7** illuminates, release **button "P"**: **Led L7** will flash **5 times** and the **flashing lamp** will illuminate: the program "learning working times" has been entered.

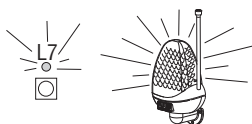

IMPORTANT: at this stage two options are allowed to go on with setting ie. learning the required operating times: by the "P" button or by remote control. The last option allows the installation agent to have direct visual control of the operation being performed by the gates.

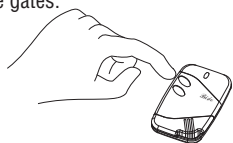

4°

4th Operation:

A pulse to open starts M1 motor
(the first gate starts opening)

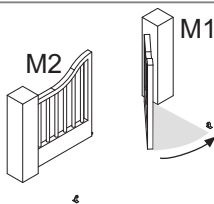
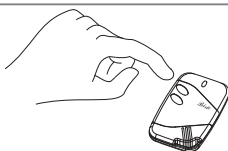

The time passing from 4th to 5th operations is stored by the system as the **Gate Delay Time in Open Cycle**, with the options in service (Dip No.6 =ON) or out of service (Dip No. 6=OFF, the time is stored but no delay will occur).

5°

5th Operation:

A pulse to open starts M2 motor
(second gate starts opening)

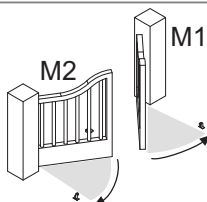
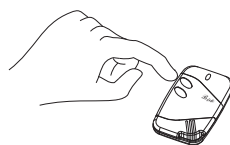

6°

6th Operation:

A pulse stops M1 motor
(first gate wide open on open gate stop)

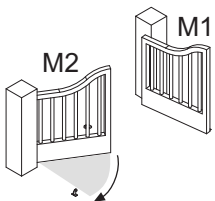
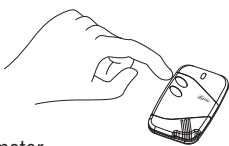

7°

7th Operation:

A pulse stops M2 motor
(second gate wide open on open gate stop)

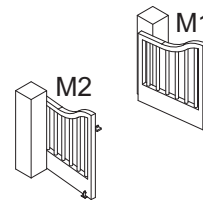
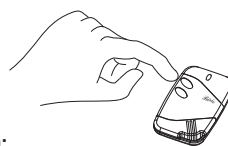

The time passing from 7th to 8th operation is stored by the system as "**Dwell Time**", in service on AUTOMATIC MODE (Dip No.3=ON) or out of service (Dip No.3=OFF, dwell time still in the system memory but not applicable).

8°

8th Operation:

A Pulse to close starts M2 motor
(M2 gate starts closing)

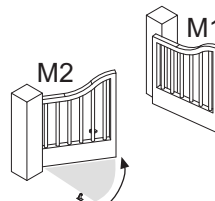
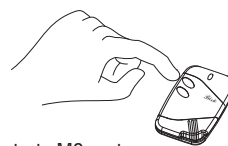

The time between the 8th and 9th operations is stored by the system as "**Gate Delay Time on Closing Cycle**"

9°

9th Operation:

A pulse to close starts M1 motor
(M1 gate starts closing)

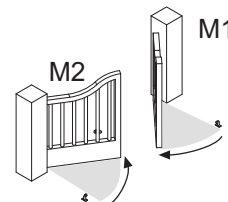
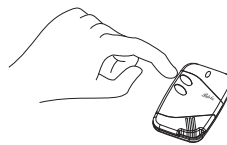

10°

10th Operation:

A pulse stops M2 motor (M2 gate on closed gate position)
In order to ensure that the gate is securely held in stop position, it is advised to pulse the actuator ie. gate to stop approx. 3-4 seconds after the gate has reached the end of the permitted stroke on the closed gate stop position.

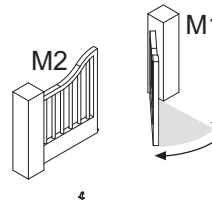
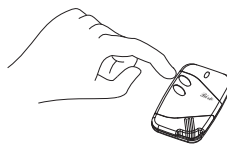

11°

11th Operation:

A pulse stops M1 motor (M1 gate on closed gate position)
In order to ensure that the gate is securely held in stop position, it is advised to pulse the actuator ie. gate to stop approx. 3-4 seconds after the gate has reached the end of the permitted stroke on the closed gate stop position.

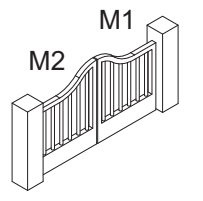
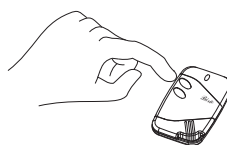

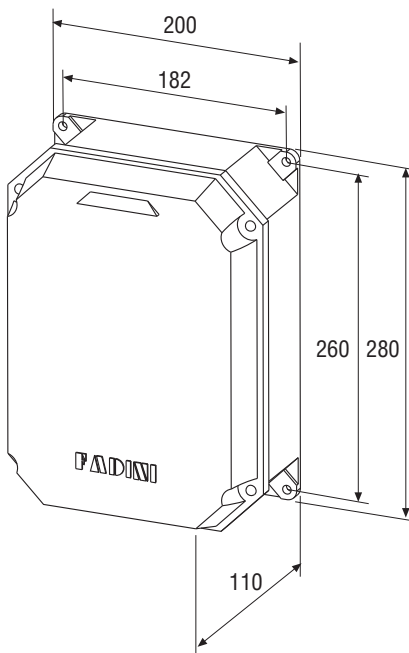

- I** - Prima dell'installazione da parte di personale tecnico qualificato, si consiglia di prendere visione del Libretto Normative di Sicurezza che la Meccanica Fadini mette a disposizione.
- GB** - Please note that installation must be carried out by qualified technicians following Meccanica Fadini's Safety Norms Manual.
- F** - L'installation doit être effectuée par un technicien qualifié suivant le manuel des Normes de Sécurité de Meccanica Fadini.
- D** - Vor der Montage durch einen Fachmann, wird es empfohlen die Anleitung zur Sicherheitsnormen, die Meccanica Fadini zur Verfügung stellt, nachzulesen.
- E** - Antes de la instalación por el personal técnico calificado, se recomienda leer detenidamente el Folleto de la Reglamentación de Seguridad que la empresa Meccanica Fadini pone a su disposición.
- NL** - Voordat de installatie door gekwalificeerd technisch personeel wordt uitgevoerd, wordt geadviseerd om het boekje met veiligheidsvoorschriften dat Meccanica Fadini ter beschikking stelt door te lezen.



I Direttiva **2003/108/CE**
Smaltimento dei materiali
elettrici ed elettronici

VIETATO GETTARE NEI RIFIUTI
MATERIALI NOCIVI PER L'AMBIENTE

GB **2003/108/CE** Directive
for waste electrical and
electronic equipments

DISPOSE OF PROPERLY
ENVIRONMENT-NOXIOUS MATERIALS



Via Mantova, 177/A - C.P. 126 - 37053 Cerea (Verona) Italy - Tel. +39 0442 330422 r.a. - Fax +39 0442 331054
e-mail: info@fadini.net - www.fadini.net